

PHILIPS

hue personal
wireless
lighting

Infuse M
Xamento M



HUE serial number



User manual
Benutzerhandbuch
Notice d'emploi
Manual de usuario
Manual do usuário
Manuale d'uso

Infuse M

Incl.

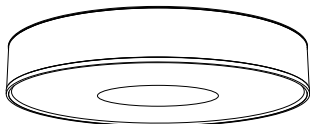

Excl.

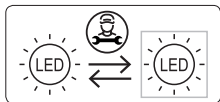
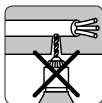
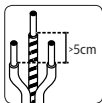
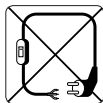
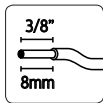
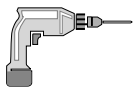

Xamento M

Incl.

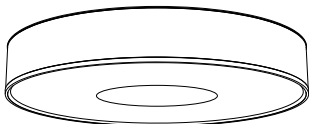

Excl.

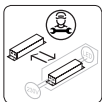
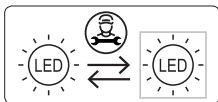
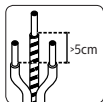
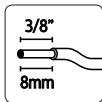
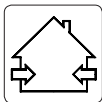
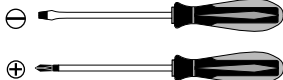
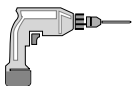

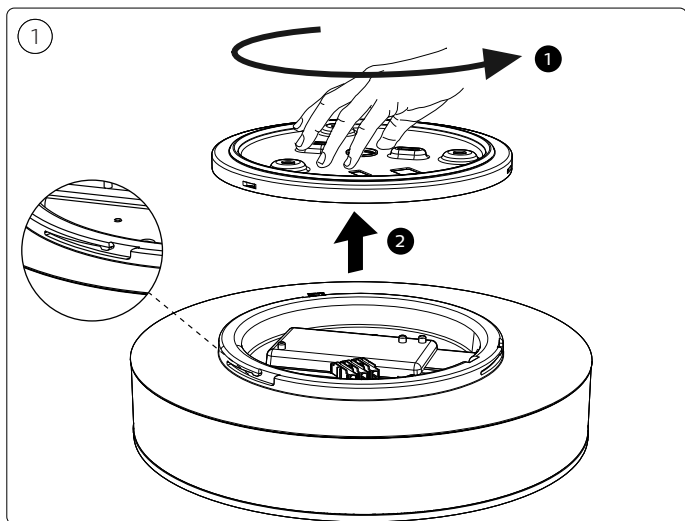
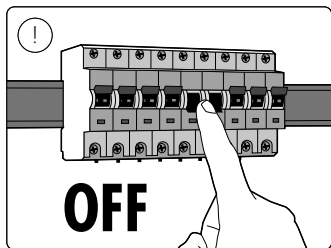

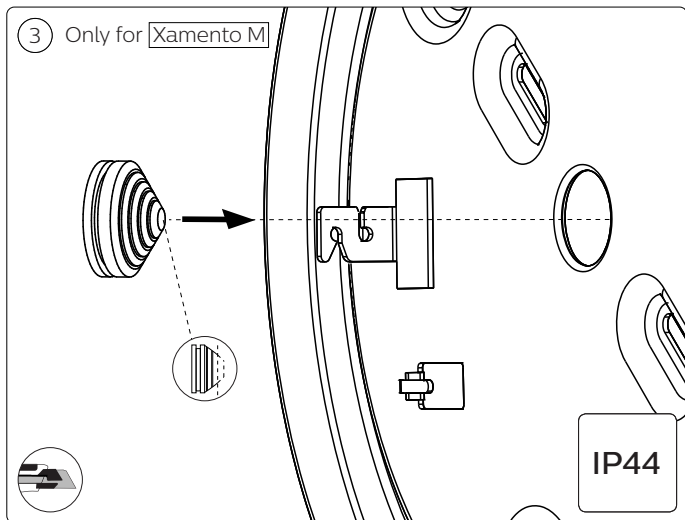
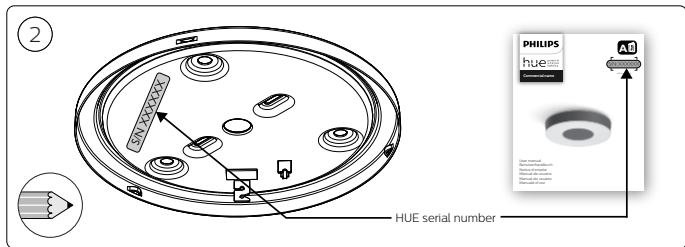

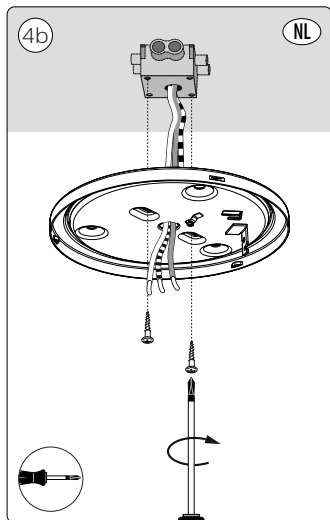
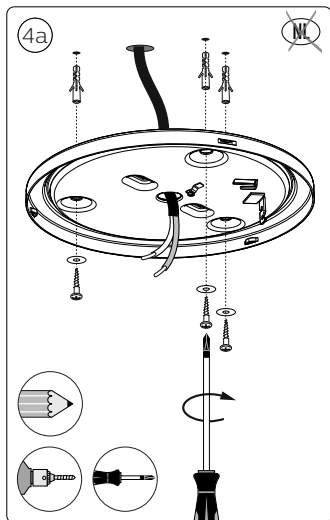

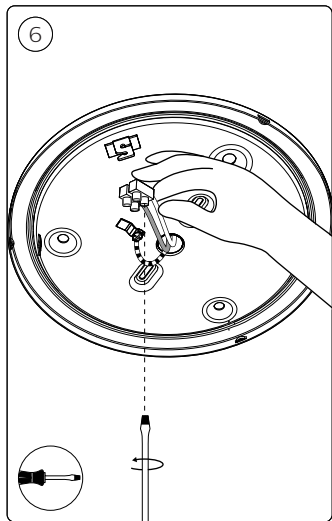
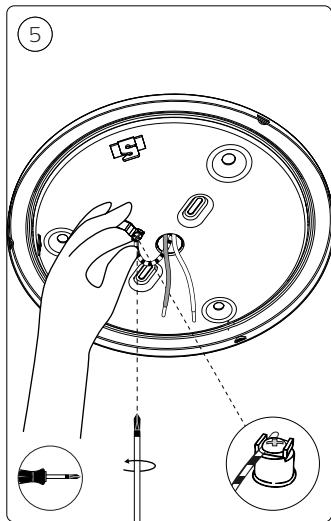

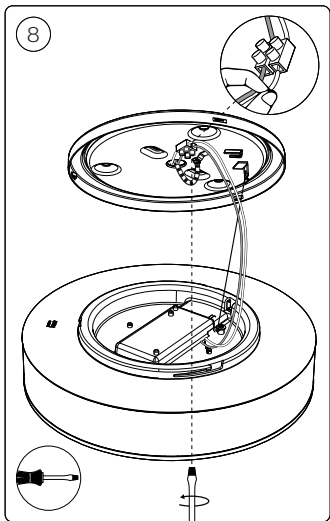
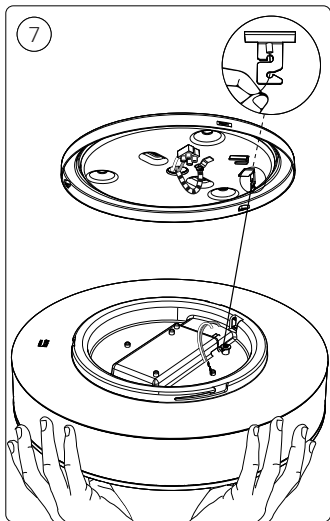

9

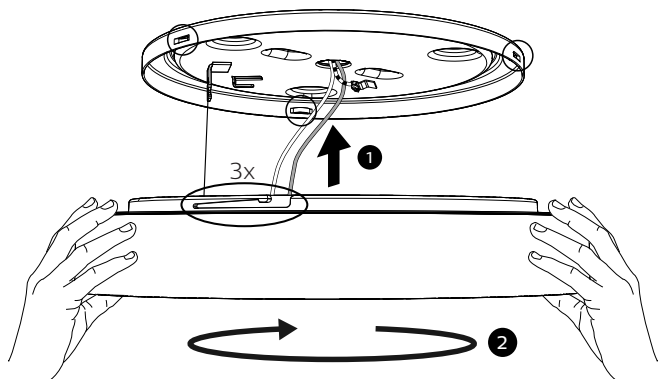

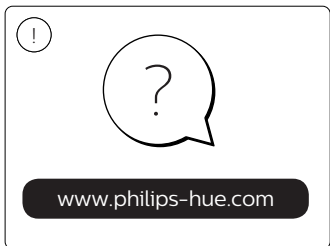
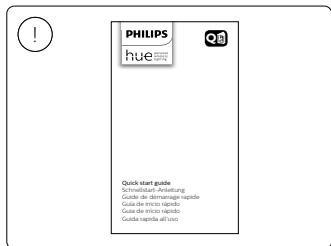
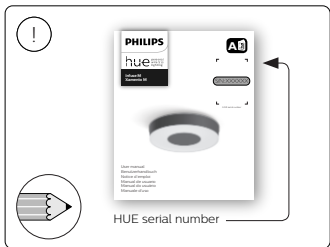
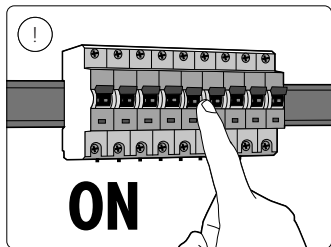



Signify
I.B.R.S. / C.C.R.I. Numéro 10461
5600 VB Eindhoven,
the Netherlands
☎00800-74454775

© 2021 Signify Holding
All rights reserved

www.philips-hue.com

4422 954 80021
Last update: 02/2021