

**PHILIPS**

DST2010, DST2020  
DST2030



Lea cuidadosamente el instructivo antes de usar su aparato







English 6  
Azərbaycanca 21  
Bahasa Indonesia 36  
Bahasa Melayu 51  
Čeština 66  
Dansk 81  
Deutsch 96  
Eesti 111  
Español 126  
Français 141  
Hrvatski 156  
Italiano 171  
Latviešu 186  
Lietuviškai 201  
Magyar 216  
Nederlands 231  
Norsk 246  
O'zbek 261  
Polski 276  
Português 291  
Português do Brasil 306  
Română 321  
Shqip 336  
Slovenščina 351  
Slovensky 366  
Srpski 381  
Suomi 396  
Svenska 411  
Tiếng Việt 426  
Türkçe 441  
Türkmençe 456  
Ελληνικά 471  
Български 486  
Кыргызча 501  
Македонски 516  
Русский 531

Тоҷикӣ 546  
Українська 561  
Қазақша 576  
Հայերեն 591  
ភាសាខ្មែរ 606  
ქართული ენა 622  
简体中文 638  
繁體中文 653  
한국어 668  
العربية 683  
فارسی 698

# Introduction

Congratulations on your purchase and welcome to Philips! To fully benefit from the support that Philips offers, register your product at [www.philips.com/welcome](http://www.philips.com/welcome). Read this user manual, the important information leaflet, and the quick start guide carefully before you use the appliance. Save them for future reference.

## Product overview

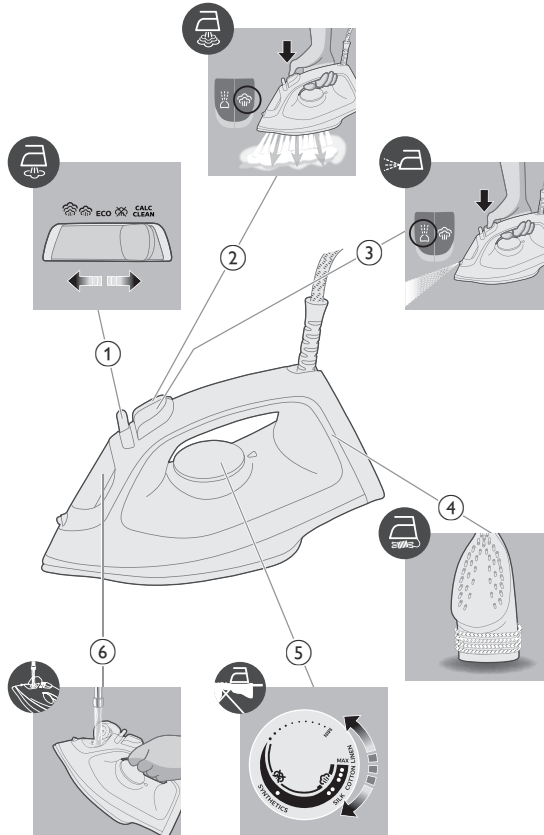

- 1 Steam selector
- 2 Steam boost button
- 3 Water spray
- 4 Cord winding
- 5 Temperature dial
- 6 Water tank lid

## Using the appliance

### Preparing for use

Note: The iron may give off some steam when you use it for the first time. This stops after a short while.

#### Type of water to use

The appliance is suitable to be used with tap water. However, if you live in an area with hard water, we recommend that you mix an equal amount of tap water with distilled or demineralized water. This will prevent fast scale build up and prolong the lifetime of the appliance.

**Do not add perfume, water from the tumble dryer, vinegar, starch, descaling agents, ironing aids, chemically descaled water or other chemicals, as they may cause water spitting, brown staining or damage to your appliance.**

### Filling the water tank

- 1 Do not plug in the appliance.

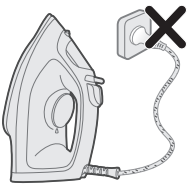

- 2 Ensure the appliance is cooled down.

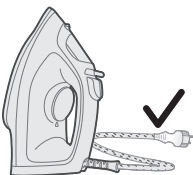

## 8 English

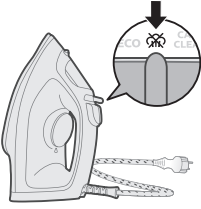

3 Slide the steam selector to the right to select no steam mode (dry ironing) .

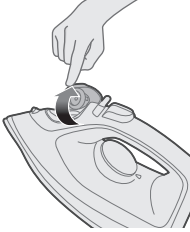

4 Flip open the water tank lid.

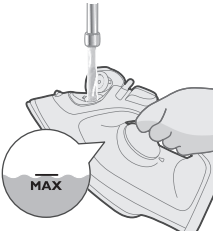

5 Fill water tank up to the MAX indication in the water tank.



6 Close the water tank lid firmly.

## Setting the temperature



MAX  
LINEN



● ● ● ●  
COTTON





**ECO**●  
SYNTHETICS**ECO**

ECO setting: Minimum constant steam is delivered continuously for garments with less creases. This setting also saves energy.



Two steam clouds: More constant steam is delivered continuously for tough creases.



Three steam clouds: Maximum constant steam is delivered continuously for stubborn creases.

## Using the appliance

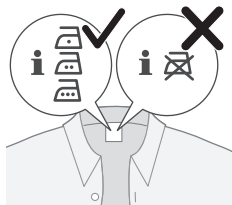

- 1 Check the garment label for the required ironing.

10 English

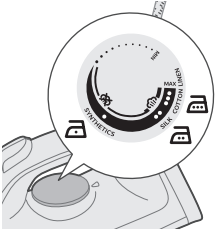

2 Set the temperature dial to the required ironing temperature by turning it to the appropriate temperature indication.

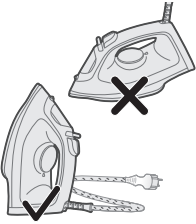

3 Allow the iron to rest on its heel.

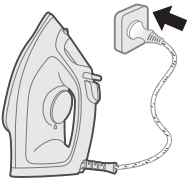

4 Plug the appliance in an earthed wall socket.

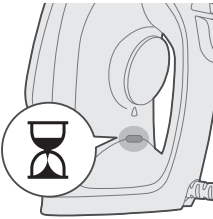

5 The iron ready light will light up, indicating iron is heating up.

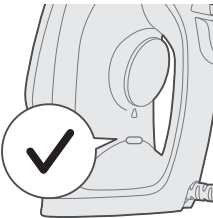

6 When the iron ready light has gone out, wait a while before you start ironing. The ready light will go on from time to time during ironing.

## No steam/Dry ironing

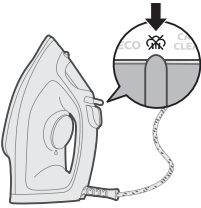

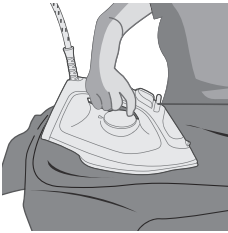

- 1 Set steam setting to no steam setting.

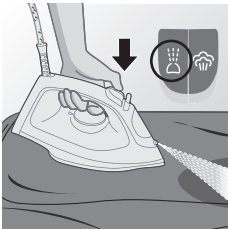

- 2 After a short while, steam will cease during ironing.

## Water spray



- 1 Set steam setting to no steam setting. Press and release the water spray button  for a stream of mist to remove stubborn creases.

## Steam boost

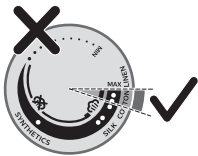

- 1 Set temperature dial to MAX setting between cotton and linen.

## 12 English

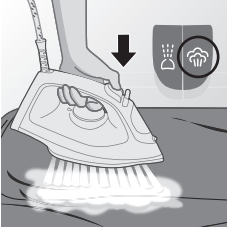

- 2 Press and release the steam boost button for a powerful boost of steam to remove stubborn creases.

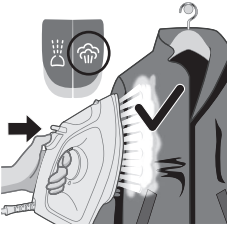

- 3 You can use the steam boost function when you hold the iron in vertical position for removing creases from hanging garments (for DST2020 and DST2030 only).

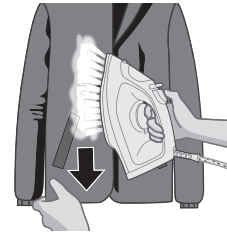

- 4 Pull and stretch your garment while applying steam boost to remove stubborn creases (for DST2020 and DST2030 only).



- 5 Do not use your bare hand as a supporting surface when you iron.



- 6 Do not position the appliance towards yourself/ another person.

## Auto shut off (DST2030)

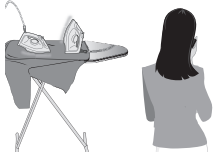

- 1** To give you a peace of mind, the appliance will cool down on its own if it is left unattended for a period of time.

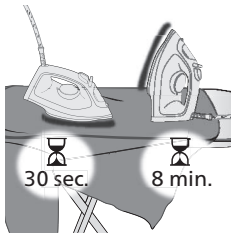

- 2** When the appliance is not in use for more than 30 seconds resting on its soleplate or 8 minutes resting on its heel/ base, the appliance will enter auto shut off mode.

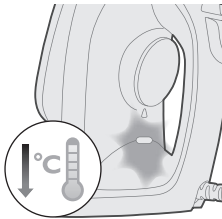

- 3** The temperature of the appliance will decrease in auto shut-off mode. The iron ready light will also flash non-stop to indicate the appliance is at auto-off status. To completely switch off the appliance, unplug the appliance from the socket.

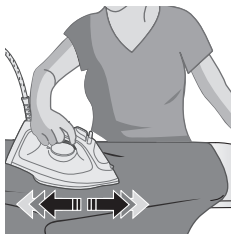

- 4** To let the appliance heat up again, pick up the appliance or move it slightly.

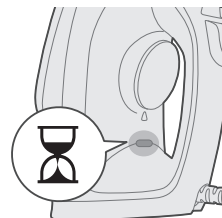

- 5** The iron ready light will light up, indicating the appliance is heating up.

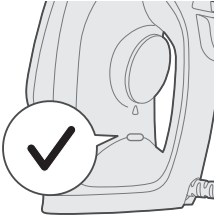

6 Once the iron ready light turns off, the appliance is ready to use.

## Cleaning and maintenance

1 Ensure appliance is not plugged in.

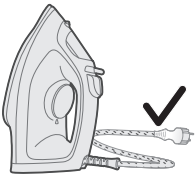
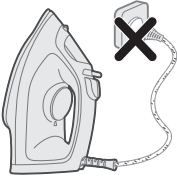

2 Ensure the appliance has cooled down.

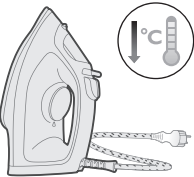

3 Wipe flakes and other deposit off the soleplate with a damp cloth.





Note: To keep the soleplate smooth, avoid hard contact with metal objects. Never use a scouring pad, vinegar or other chemicals to clean the soleplate.

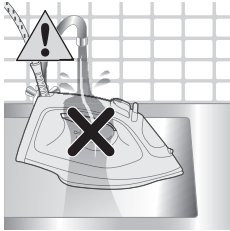

- 4 Do not wash/ clean the appliance under running water.

## Calc-Clean



Tip: The Quick Calc Release function can be used at any time. If you live in a hard water area, use the function more frequently.

- 1 After 1 month of use, it is recommended to perform calc clean to remove scales collected from your appliance to prolong its life and ensure the appliance heats up.

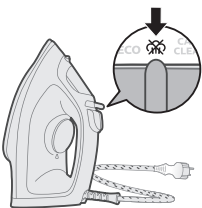

- 2 Make sure the iron is unplugged and the steam setting is set to no steam mode (dry ironing) .

16 English

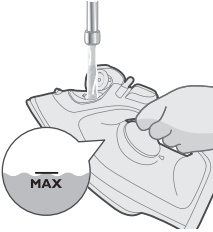

3 Fill the water tank to the MAX indication.



4 Set the temperature dial to MAX.

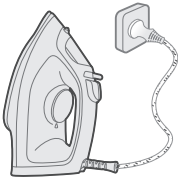

5 Plug in appliance to an earthed wall socket.

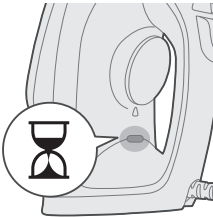

6 The iron ready light will light up, indicating the appliance is heating up.

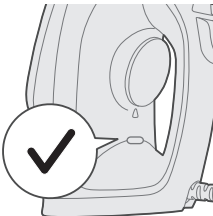

7 Wait for iron ready light to go out.



**8** Unplug the iron.

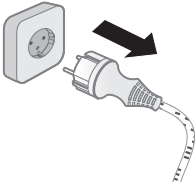

**9** Slide the steam selector to the Calc-Clean position and hold it.

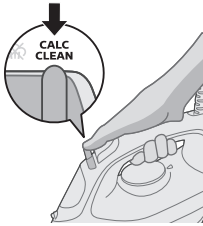

**10** Hold the iron over the sink and gently shake the iron. Hot water and calc particles will be released from the soleplate.

Caution: While scale is flushed out, steam and boiling water also come out of the soleplate.



**11** Continue to shake the iron until all the water in the water tank has been released.

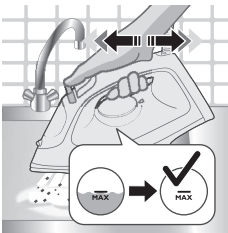

**12** Plug in the appliance and let the appliance heat up to dry the soleplate. This takes about 2 minutes.

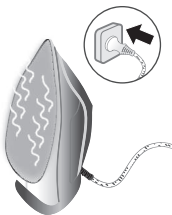

## 18 English

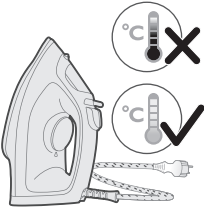

**13** Let the iron cool down.

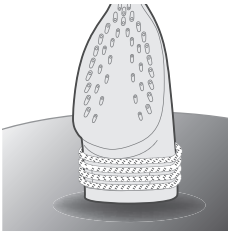

**14** Wind the cord around the heel of the iron.

## Storage

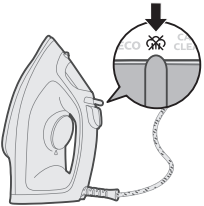

**1** Slide the steam selector to select no steam mode (dry ironing) .

**2** Unplug the appliance.

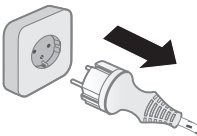

**3** Let the appliance cool down.

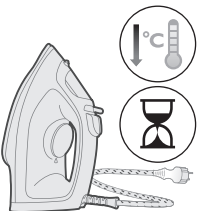

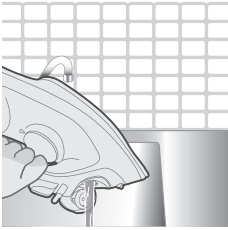

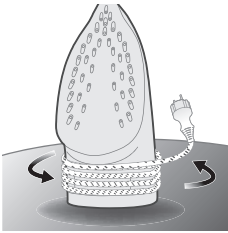

- 4 Pour any remaining water out of the water tank.





- 5 Wind the power cord around the main body of the appliance.

## Trouble shooting

This chapter summarizes the most common problems you could encounter with the appliance. If you are unable to solve the problem with the information below, visit [www.philips.com/support](http://www.philips.com/support) for a list of frequently asked questions or contact the Consumer Care Center in your country.

Problem	Possible cause	Solution
The iron cannot remove wrinkles from the garment.	There is no steam during ironing.	Fill the water tank and set the steam slider to  .
The iron does not produce any steam.	There is not enough water in the tank.	Fill the water tank.
	The steam slider is set to  .	Set the steam slider to  .
Water droplets drips onto the garment during ironing.	The iron is not hot enough yet to produce steam.	When the iron is heating up, the "iron-ready" light is steady on. When the iron is ready for use, the light turns off.
	You have used the boost function too often within a short period.	Continue ironing in horizontal position and wait a while before you use the steam boost function again.
	You have not closed the water tank lid properly.	Press the lid until you hear a 'click'.

## 20 English

The iron does not produce a steam boost.	You have used the steam boost function too often within a short period.	Continue ironing in horizontal position and wait a while before you use the steam boost function again.
	The iron is not hot enough for ironing yet.	Wait until the 'iron ready' light has stopped flashing and lights up steadily.
	You have put a chemical into the water tank.	Rinse the water tank and do not put any perfume or chemicals into the water tank.
Water drips from the soleplate after the iron has been unplugged.	The steam slider is set to  .	Set the steam slider to  .
	You have put the iron in horizontal position with water still left in the water tank.	Empty the water tank after use, or store the iron in vertical position.
The iron leaves a shine or an imprint on the garment.	The surface to be ironed was uneven, for instance because you ironed over a seam or a fold in the garment.	The iron is safe to use on all ironable garments. The shine or imprint is not permanent and disappears when you wash the garment. Avoid ironing over seams or folds. You can also place a cotton cloth over the area to be ironed to avoid imprints.

## Giriş

Philips-dən alış-veriş etdiyiniz üçün sizi təbrik edirik və "Philips-ə xoş gəlmisiniz" deyirik! Philips-in təklif etdiyi dəstəkdən tam şəkildə yararlanmaq üçün məhsulunuzu [www.philips.com/welcome](http://www.philips.com/welcome) sahifəsində qeydiyyatdan keçirin. Cihazdan istifadəyə başlamazdan əvvəl bu təlimat kitabçasını, vacib məlumatlar bukletini və başlamaq haqqında qısa təlimatı oxuyun. Onları gələcəkdə istinad etmək üçün saxlayın.

## Məhsul icmalı

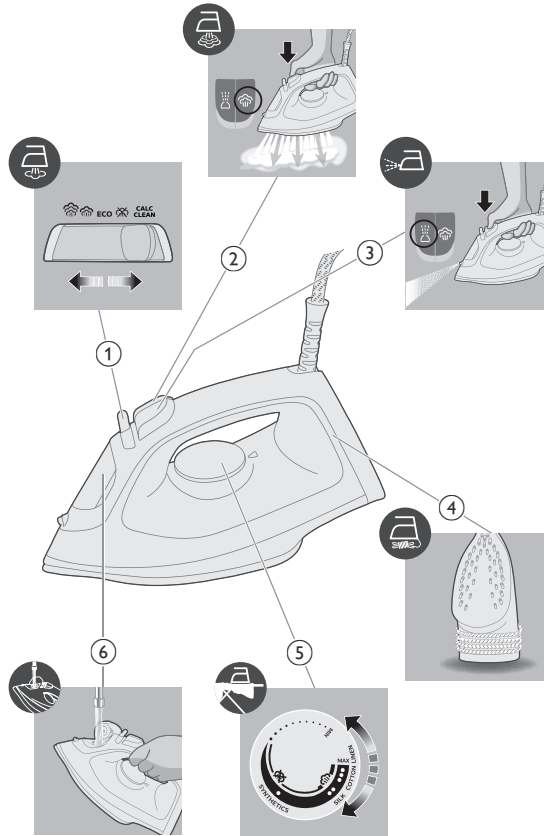

- 1 Buxar rejimi seçimi
- 2 Buxar gücləndirmə düyməsi
- 3 Su spreyi
- 4 Kabelləri sarıma bölməsi
- 5 Temperatur siferblatı
- 6 Su çəninin qapağı

## Cihazdan istifadə

### İstifadəyə hazırlanır

Qeyd: İlk dəfə istifadə etdiyiniz zaman ütüdən bir qədər tüstü çıxa bilər. Bu, qısa müddətdən sonra dayanır.

#### İstifadə olunacaq suyun növü

Cihazı kran suyu ilə istifadə etmək tövsiyə edilir. Ancaq sərt suyu olan bölgədə yaşayırınsınızsa, bərabər miqdarda kran suyunu distillə edilmiş və ya mineraldan təmizlənmiş su ilə qarışdırmağı məsləhət görürük. Bu, ərpın toplanmasının qarşısını alacaq və cihazın istismar müddətini uzadacaq.

**Ətir, su, qurutma maşınından götürülmüş su, sirkə, nişasta, ərp təmizləyici vasitələr, ütüləmə vasitələri, kimyəvi təmizlənmiş su və ya digər kimyəvi maddələrdən istifadə etməyin, çünki onlar su damcılmasına, qəhvəyi rəngli ləkələnməyə və ya cihazınızın zədələnməsinə səbəb ola bilər.**

### Su çəninini doldurmaq

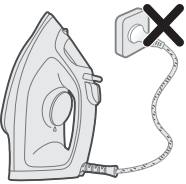

- 1 Cihazı elektrik şəbəkəsinə qoşmayın.

2 Cihazın soyuduğundan əmin olun.

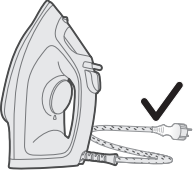

3 Buxarsız rejimi (quru ütüləmə) seçmək üçün buxar rejimi seçimi düyməsini sağa sürüşdürün ~~☒~~.

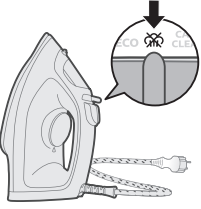

4 Su çəninin qapağını açın.

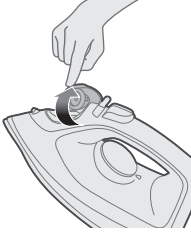

5 Su çəni MAKSİMUM göstəricisinə qədər doldurun.

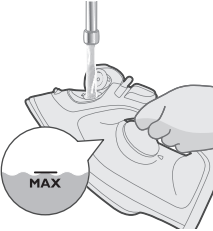

6 Su çəninin qapağını möhkəm bağlayın.

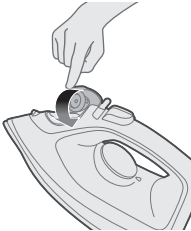

## Parametri təyin etmək



MAKSİMUM  
KƏTAN



● ● ●  
PAMBIQ



● ●  
İPƏK

**ECO**



●  
SİNTETİK



ECO



ECO parametri: Daha az qırıqlı parçalar üçün davamlı şəkildə minimum miqdarda buxar təmin edilir. Bu parametrlər enerjini qənaət edir.



İki buxar buludu: Çətin qırıqları aradan qaldırmaq üçün daha davamlı şəkildə buxar aralıqsız olaraq təmin edilir.



Üç buxar buludu: Açılmayan qırıqları aradan qaldırmaq üçün davamlı olaraq maksimum miqdarda buxar təmin edilir.



## Cihazdan istifadə

- 1 Tələb edilən ütüləmə göstərişləri ilə bağlı paltardakı etiketə nəzər salın.

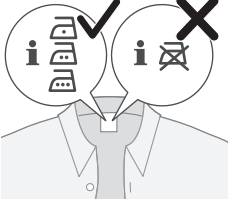

- 2 Temperatur çarxını müvafiq temperatur göstəricisinə doğru fırlatmaqla tələb edilən ütüləmə temperaturuna gətirin.

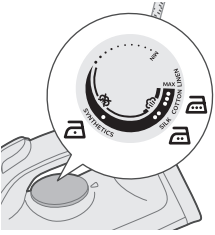

- 3 Ütünü özülü üstə qoyun.

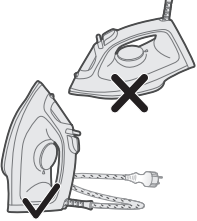

- 4 Cihazı torpaqlanmış divar rozetkəsinə taxın.

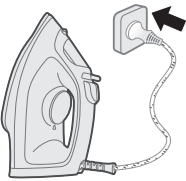

- 5 "Ütü hazır" işığı yanaraq ütünün qızdığını göstərəcək.

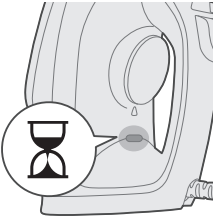

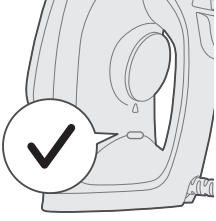

6 "Ütü hazırdır" işığı söndükdən sonra ütüləməyə başlamazdan əvvəl bir az gözləyin. "Hazırdır" işığı ütüləmə zamanı arabit yanacaq.

## Buxarsız/Quru ütüləmə

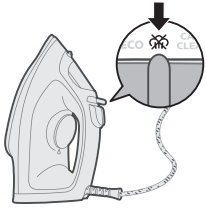

1 Buxar rejimi parametrini buxarsız rejim parametrinə dəyişi

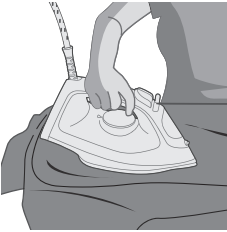

2 Qısa müddət sonra ütüləmə zamanı buxar dayanacaq.

## Su spreyi

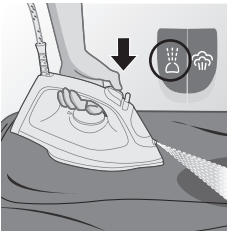

1 Buxar rejimi parametrini buxarsız rejim parametrinə dəyişi Açılmayan qırıqları aradan qaldırmaq üçün paltarı nəmləndirmək məqsədilə su spreyi düyməsinə basıb buraxın.

## Buxar gücləndirmə

- 1 Temperatur çarxını pambıq ilə kətan arasında MAKSİMUM göstəriciyə təyin edin.

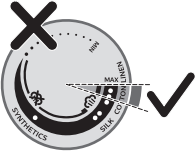

- 2 Açılmayan qırıqları güclü buxarla açmaq üçün buxar gücləndirmə düyməsinə basıb buraxın.

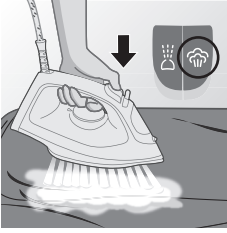

- 3 Ütünü şaquli vəziyyətdə tutarkən asılı paltarlardakı (yalnız DST2020 və DST2030 üçün) qırıqları açmaq üçün buxar gücləndirmə funksiyasından istifadə edə bilərsiniz.

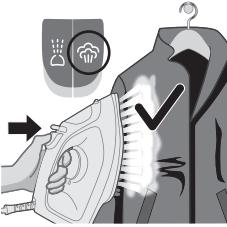

- 4 Açılmayan qırıqları aradan qaldırmaq üçün güclü buxardan istifadə edərkən paltarı tutub dartın (yalnız DST2020 və DST2030 üçün).

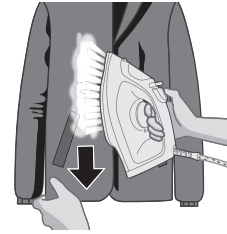

- 5 Ütüləyən zaman çılpaq əlinizi dayaq səthi kimi istifadə etməyin.





6 Cihazı özünüzə/başqasına tərəf tutmayın.

## Avtomatik sönmə (DST2030)



1 Rahatlığınız üçün qeyd edək ki, cihaz bir müddət istifadə edilməyə, öz-özünə soyuyacaq.

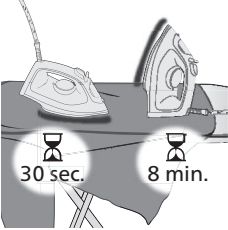
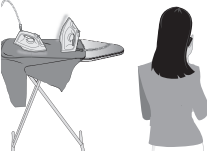

2 Cihaz öz altlığının üstündə 30 saniyədən çox qalaraq istifadə edilmədikdə və ya dabanı/özülü üzərində 8 dəqiqə dayandıqda avtomatik sönmə rejiminə keçid edəcək.

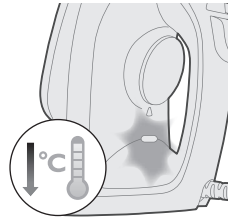

3 Cihazın temperaturu azalaraq avtomatik sönmə rejiminə keçəcək. Cihazın avtomatik sönmə vəziyyətində olduğunu göstərmək üçün "ütü hazırdır" işığı dayanmadan yanıb-sönəcək. Cihazı tamamilə söndürmək üçün onu rozetkadan çıxarın.

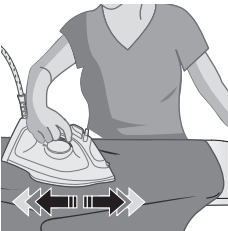

4 Cihazın yenidən isinməsinə imkan vermək üçün cihazı götürüb, ehmalca hərəkət etdirin.

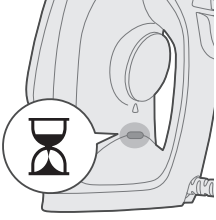

5 "Ütü hazırdır" işığı yanaraq cihazın qızdığını göstərəcək.

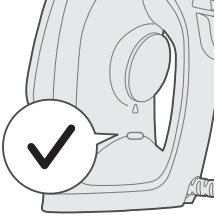

6 "Ütü hazırdır" işığı sönən kimi cihaz istifadəyə hazır olur.

## Təmizlik və baxım

1 Cihazın elektrik enerjisinə qoşulmadığından əmin olun.

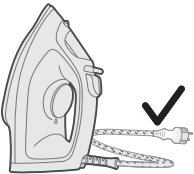
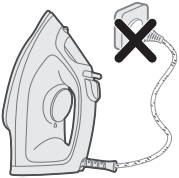

2 Cihazın soyuduğundan əmin olun.

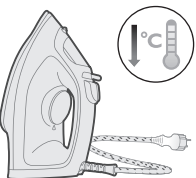

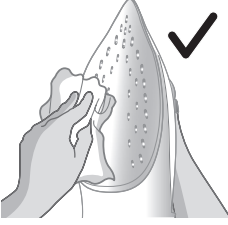

3 Altlıqdakı ləkələri və başqa çöküntüləri nəm parça ilə silin.



Qeyd: Ütü altlığını hamar saxlamaq üçün metal əşyalar ilə sərt təmasdan çəkinin. Ütü altlığını təmizləmək üçün heç vaxt aşındırıcı süngər, sirkə və ya digər kimyəvi maddələrdən istifadə etməyin.

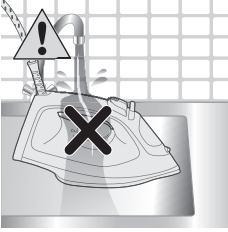

4 Cihazı axan suyun altında yumayın/təmizləməyin.

## Ərpin təmizlənməsi

Məsləhət: Sürətli Ərp Təmizlənməsi funksiyası istənilən zaman istifadə edilə bilər. Yaşadığınız ərazidə su sərtdirsə, funksiyadan daha tez-tez istifadə edin.



1 1 aylıq istifadədən sonra cihazınızın istifadə müddətini uzatmaq və onun isinməsinə təmin etmək üçün cihazınızdan toplanmış ərpləri təmizləmək məqsədilə ərpin təmizlənməsi işini icra etmək tövsiyə edilir.

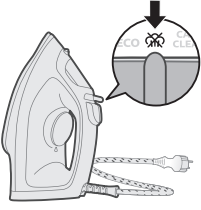

2 Ütünün elektrik şəbəkəsindən ayrıldığından və buxar parametrisinin buxarsız rejimə təyin edildiyindən əmin olun.

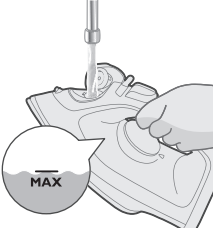

3 Su çənini MAKSİMUM göstəriciyə qədər doldurun.

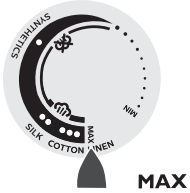

4 Temperatur çarxını MAKSİMUM göstəriciyə gətirin.

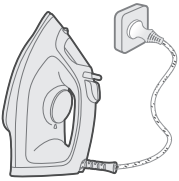

5 Cihazı torpaqlanmış divar rozetkəsinə qoşun.

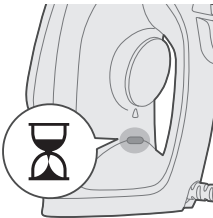

6 "Ütü hazır" işığı yanaraq cihazın qızdığını göstərəcək.

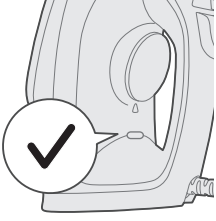

7 "Ütü hazırdır" işığının sönməyini gözləyin.

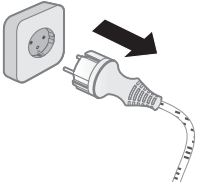

8 Ütünü elektrik enerjisindən ayırın.

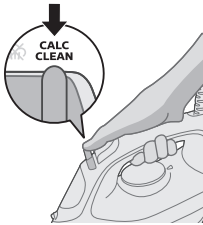

9 Buxar rejimi seçimi düyməsini Ərpin Təmizlənməsi vəziyyətinə gətirib saxlayın.



10 Ütünü çanağın üstündə tutun və yüngülcə silkələyin. İsti su və ərp hissəcikləri altlıqdan töküləcək.

Diqqət: Ərp təmizlənmərkən ütü altlığından buxar və qaynar su da çıxır.

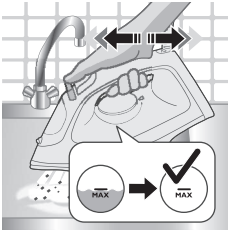

11 Su çəninəki bütün su boşalana qədər ütünü silkəlməyə davam edin.



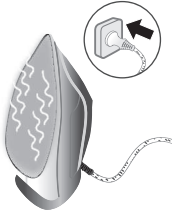

**12** Cihazı cərəyan şəbəkəsinə qoşun və ütü altlığının quruması üçün cihazın isinməsinə imkan verin. Bu, təxminən 2 dəqiqə çəkir.

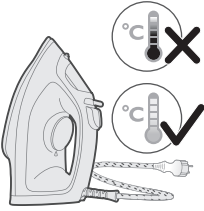

**13** Ütünün soyumasını gözləyin.

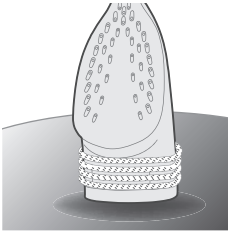

**14** Naqili ütünün özülünə sarıyın.

## Saxlama

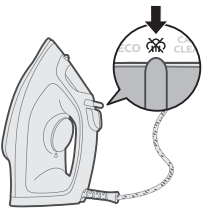

**1** Buxar rejimi seçimi düyməsini buxarsız rejimə gətirmək üçün sürüşdürün (quru ütüləmə) ~~STEAM~~.

**2** Cihazı cərəyan şəbəkəsindən ayırın.

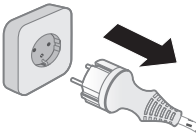

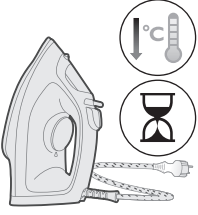

3 Cihazın soyumasını gözləyin.

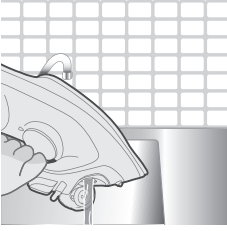

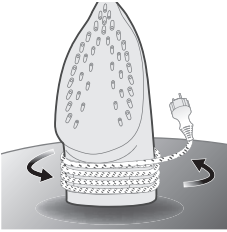

4 Su çənində qalan suyu boşaldın.



5 Enerji naqilini cihazın özülünün ətrafında sarıyın.

## Nasazlıqların aradan qaldırılması

Bu fəsilə cihazda qarşılaşa biləcəyiniz ən ümumi problemlər qeyd edilib. Aşağıdakı məlumatlarla problemi həll edə bilməyənlər, tez-tez verilən sualların siyahısına baxmaq üçün [www.philips.com/support](http://www.philips.com/support) linkinə daxil olun və ya ölkənizdəki İstehlakçılara Yardım Mərkəzi ilə əlaqə saxlayın.

Problem	Mümkün səbəb	Həll
Ütü paltarın qırışlarını aradan qaldıra bilmir.	Ütüləmə zamanı buxar vermir.	Su çənini doldurun və buxar rejimi seçimi düyməsini  vəziyyətinə gətirin.
Ütüdən buxar gəlmir.	Su çənində kifayət qədər su yoxdur.	Su çənini doldurun.
	Buxar rejimi seçimi düyməsi  vəziyyətinə gətirilib.	Buxar rejimi seçimi düyməsini  vəziyyətinə gətirin.
	Ütü buxar verəcək qədər isti deyil.	Ütü qızarkən "ütü hazırdır" işığı sabit şəkildə yanır. Ütü istifadəyə hazır olduqda işıq sönür.

Ütüləyərəkən materialın üzərinə su damcıları düşür.	Qısa müddət ərzində buxar gücləndirmə funksiyasından tez-tez istifadə etməsəniz.	Buxar gücləndirmə funksiyasından yenidən istifadə etməzdən əvvəl horizontal vəziyyətdə ütüləməyə davam edin və bir müddət gözləyin.
	Su çəninin qapağını yaxşı bağlamamısınız.	"Klik" səsinə eşidənə qədər qapağa basın.
Buxar gücləndiricisi işləmir.	Qısa müddət ərzində buxar gücləndirmə funksiyasından tez-tez istifadə etməsəniz.	Buxar gücləndirmə funksiyasından yenidən istifadə etməzdən əvvəl horizontal vəziyyətdə ütüləməyə davam edin və bir müddət gözləyin.
	Ütü hələ ütüləmə üçün kifayət qədər isinməyib.	"Ütü hazırdır" işığının yanıb-sönməsi dayanana və işıqlar sabit şəkildə yanana qədər gözləyin.
	Su çəninə kimyəvi maddə tökmüsünüz.	Su çəninə yaxalayın və ona hər hansı ətir, yaxud kimyəvi maddə tökməyin.
Ütünü şəbəkədən ayırdıqdan sonra ütü altlığında su damcıları yaranır.	Buxar rejimi seçimi düyməsi  vəziyyətinə gətirilib.	Buxar rejimi seçimi düyməsini  vəziyyətinə gətirin.
	Su çəninə su olduğu halda ütünü horizontal istiqamətdə qoymusunuz.	İstifadədən sonra su çəninə boşaldın və ya ütünü şaquli vəziyyətdə saxlayın.
Ütü paltarda parlaqlıq və ya iz buraxır.	Ütülənən səth düz deyildi, məsələn, paltarda tikişi və ya qat yerini ütüləmisiniz.	Ütünün bütün ütülənən parçalarda istifadəsi təhlükəsizdir. Parlaqlıq və ya iz qalıcı deyil və paltarı yuduğunuz zaman yox olur. Tikiş və ya qatların üzərini ütüləməyin. Həmçinin izlərin qarşısını almaq üçün ütülənəcək sahəyə pambıq parça da sərə bilərsiniz.

# Pendahuluan

Terima kasih telah membeli produk Philips! Untuk mendapatkan manfaat dukungan Philips secara penuh, daftarkan produk Anda di [www.philips.com/welcome](http://www.philips.com/welcome). Baca petunjuk pengguna ini, sebaran informasi penting, dan panduan mulai singkat dengan saksama sebelum Anda menggunakan alat ini. Simpanlah sebagai referensi jika dibutuhkan kelak.

## Ringkasan produk

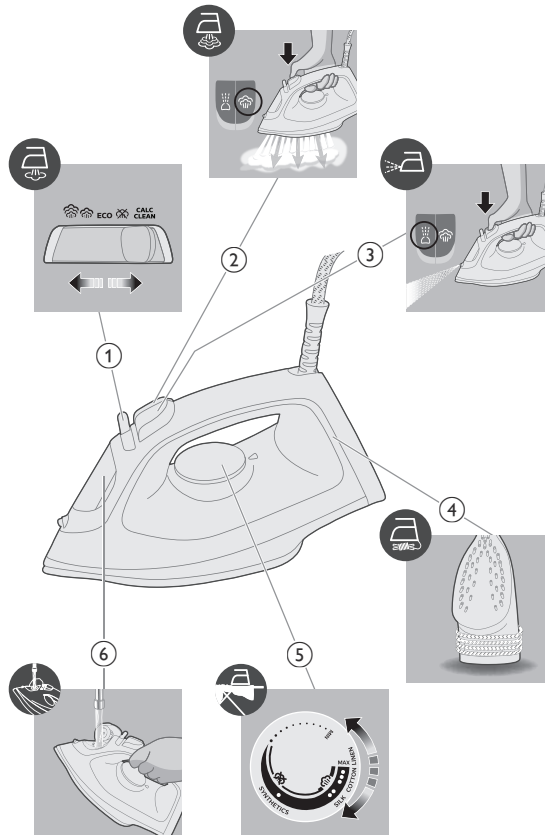

- 1 Pemilih uap
- 2 Tombol semburan uap
- 3 Semprotan air
- 4 Penggulungan kabel
- 5 Putaran suhu
- 6 Tutup tangki air

## Menggunakan alat

### Persiapan sebelum menggunakan

Catatan: Setrika mungkin akan mengeluarkan uap saat pertama kali digunakan. Hal ini akan berhenti setelah beberapa saat.

#### Jenis air yang digunakan

Alat ini dapat menggunakan air keran. Namun, jika Anda tinggal di daerah dengan kesadahan air yang tinggi, sebaiknya campurkan air keran dengan air suling/demineralisasi dengan perbandingan yang sama. Hal ini akan mencegah terbentuknya kerak dengan cepat dan memperpanjang masa pakai alat.

**Jangan tambahkan pewangi, air dari pengering pakaian, cuka, kanji, zat pembersih kerak, bahan pelembut penyetrikaan, bahan kimia pembersih kerak, atau bahan kimia lain karena dapat menyebabkan air menyembur, menimbulkan noda cokelat, atau kerusakan pada alat.**

### Mengisi tangki air

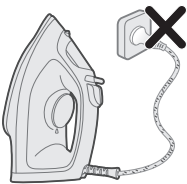

- 1 Jangan colokkan steker alat ke stopkontak.

2 Pastikan alat sudah dingin.

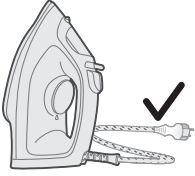

3 Geser pemilih uap ke kanan untuk memilih mode tanpa uap (penyetrikaan kering) ~~☒~~.

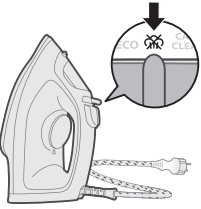

4 Buka tutup tangki air.





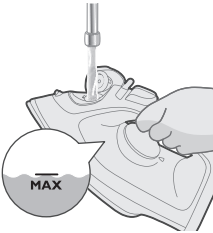





5 Isi tangki air hingga mencapai tanda MAKS.



6 Pasang tutup tangki air dengan benar.



## Menyetel suhu

		
	MAX LINEN	
	● ● ● KATUN	
	● ● SUTRA	<b>ECO</b>
	● BAHAN SINTETIS	

ECO



Pengaturan ECO: Uap konstan minimal dikeluarkan terus-menerus untuk menghilangkan kekusutan minimal. Pengaturan ini juga hemat energi.



Dua awan uap: Lebih banyak uap konstan dikeluarkan terus-menerus untuk menghilangkan kekusutan standar.



Tiga awan uap: Uap konstan maksimal dikeluarkan terus-menerus untuk menghilangkan kekusutan yang membandel.

## Menggunakan alat

- 1 Periksa anjuran metode penyetrikaan pada label pakaian.

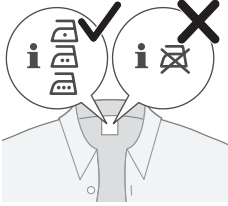

- 2 Atur putaran suhu ke suhu penyetrikaan yang sesuai.

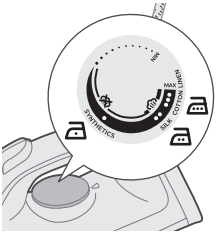

- 3 Letakkan setrika pada posisi berdiri.

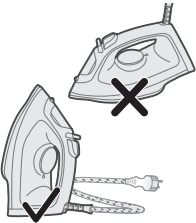

- 4 Colokkan steker alat ke stopkontak dinding yang memiliki arde.

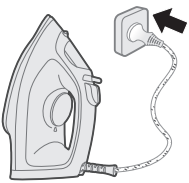

- 5 Lampu 'setrika siap' akan menyala yang menandakan setrika sedang dipanaskan.

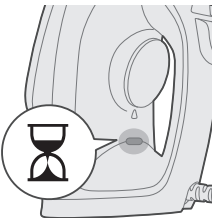



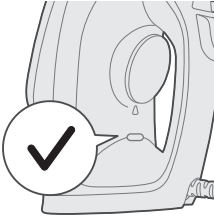

- 6 Setelah lampu 'setrika siap' padam, tunggu sebentar sebelum Anda mulai menyetrikan. Lampu 'siap' akan menyala sesekali saat menyetrikan.

## Tanpa uap/Penyetrikan kering

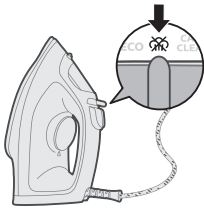

- 1 Atur ke pengaturan tanpa uap.

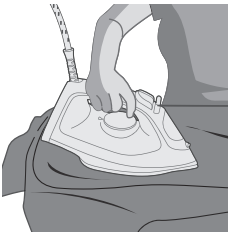

- 2 Setelah beberapa saat, uap akan berhenti dikeluarkan saat menyetrikan.

## Semprotan air

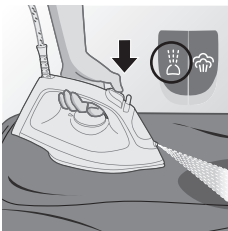

- 1 Atur ke pengaturan tanpa uap. Tekan dan lepaskan tombol semprotan air untuk menghilangkan kekusutan yang membandel.

## Semburan uap

- 1 Atur putaran suhu ke pengaturan MAKS. (di antara katun dan linen).

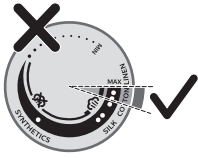

- 2 Tekan dan lepaskan tombol semburan uap untuk menghilangkan kekusutan yang membandel.



- 3 Anda dapat menggunakan fungsi semburan uap saat memegang setrika pada posisi vertikal untuk menghilangkan kekusutan pada pakaian yang digantung (khusus DST2020 dan DST2030).

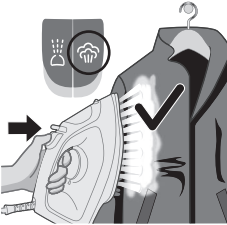

- 4 Tarik dan rentangkan pakaian Anda saat menyemburkan uap untuk menghilangkan kekusutan yang membandel (khusus DST2020 dan DST2030).

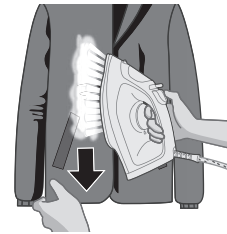

- 5 Jangan gunakan tangan kosong untuk mengalasi pakaian saat menguapinya.



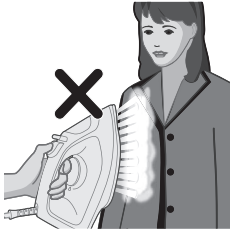

- 6 Jangan arahkan alat menghadap Anda atau orang lain.

## Mati otomatis (DST2030)



- 1 Tak perlu khawatir, alat akan mendingin secara otomatis jika ditinggalkan tanpa pengawasan selama beberapa saat.

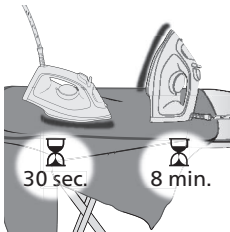
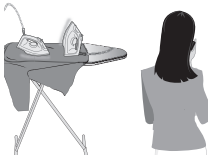

- 2 Jika alat tidak digunakan selama lebih dari 30 detik dengan posisi tapaknya menyentuh meja setrika atau 8 menit pada posisi berdiri, alat akan memasuki mode mati otomatis.

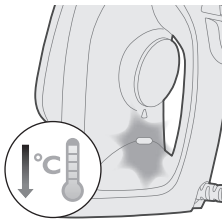

- 3 Suhu alat akan menurun dalam mode mati otomatis. Lampu 'setrika siap' juga akan berkedip nonstop untuk menandakan alat berada dalam mode mati otomatis. Untuk mematikan alat sepenuhnya, cabut steker alat dari stopkontak.

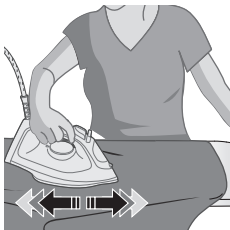

- 4 Untuk memanaskan alat kembali, angkat dan gerakkan sedikit.

## 44 Bahasa Indonesia

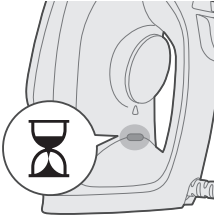

5 Lampu 'setrika siap' akan menyala yang menandakan alat sedang dipanaskan.

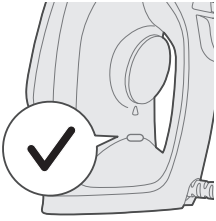

6 Setelah lampu 'setrika siap' padam, alat siap digunakan.

## Pembersihan dan pemeliharaan

1 Pastikan steker alat tidak dicolokkan ke stopkontak.

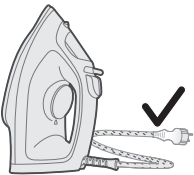
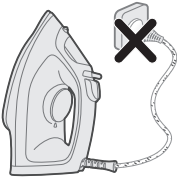

2 Pastikan alat sudah dingin.

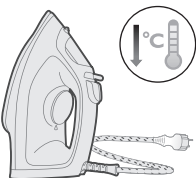

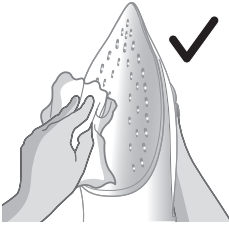

- 3 Lap kerak air dan endapan lain dari tapak setrika menggunakan kain lembap.



Catatan: Agar tapak setrika tetap licin, hindari kontak dengan benda logam. Jangan sekali-kali menggunakan sabut gosok, cuka, atau bahan kimia lain untuk membersihkan tapak setrika.



- 4 Jangan mencuci atau membersihkan alat di bawah air mengalir.

## Calc-Clean



Tip: Fungsi Quick Calc Release dapat digunakan kapan saja. Jika Anda tinggal di daerah dengan kesadahan air yang tinggi, gunakan fungsi ini lebih sering.

- 1 Setelah digunakan selama 1 bulan, sebaiknya lakukan Calc-Clean untuk menghilangkan kerak yang menumpuk pada alat Anda untuk memperpanjang masa pakainya dan memastikan alat dapat tetap panas secara optimal.

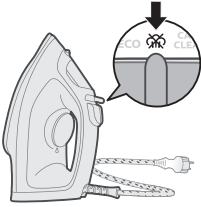

2 Pastikan steker alat sudah dicabut dari stopkontak dan alat diatur ke mode tanpa uap (penyetrikaan kering) .

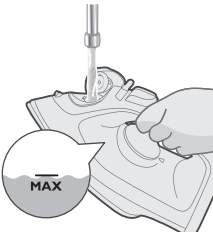

3 Isi tangki air hingga mencapai tanda MAKS.



4 Atur putaran suhu ke MAKS.

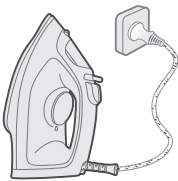

5 Colokkan steker alat ke stopkontak dinding yang memiliki arde.

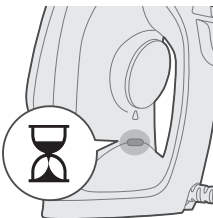

6 Lampu 'setrika siap' akan menyala yang menandakan alat sedang dipanaskan.

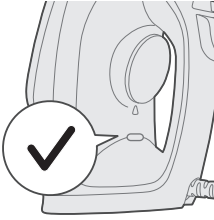

7 Tunggu hingga lampu 'setrika siap' padam.

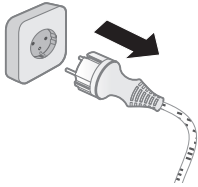

8 Cabut steker setrika dari stopkontak.

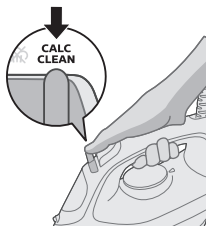

9 Geser pemilih uap ke posisi Calc-Clean dan pegang.



10 Pegang setrika di atas wastafel dan goyangkan perlahan. Air panas dan partikel kerak akan keluar dari tapak setrika.

Perhatian: Saat kerak dibilas, uap dan air mendidih juga akan keluar dari tapak setrika.

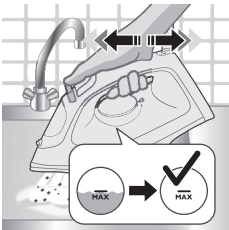

11 Terus goyangkan setrika hingga semua air di dalam tangki keluar.

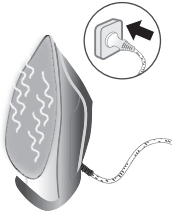

12 Colokkan steker alat ke stopkontak dan biarkan alat memanaskan hingga tapaknya kering. Proses ini membutuhkan waktu sekitar 2 menit.

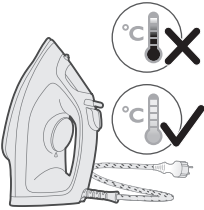

13 Biarkan setrika mendingin.

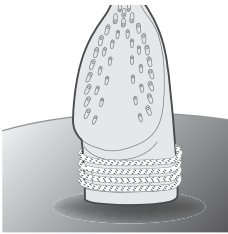

14 Gulung kabel di sekeliling kaki setrika.

## Penyimpanan

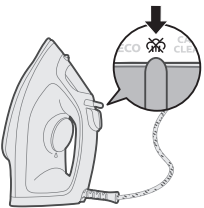

1 Geser pemilih uap untuk memilih mode tanpa uap (penyetrikaan kering) ~~OFF~~.

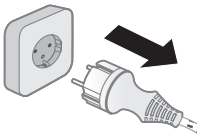

2 Cabut steker alat dari stopkontak.



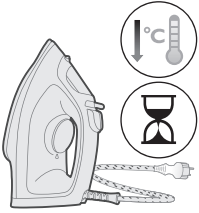

3 Biarkan alat mendingin.

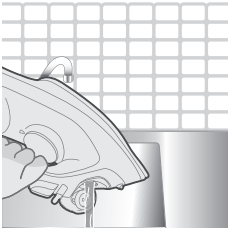

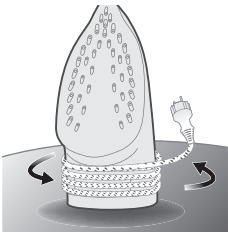

4 Keluarkan sisa air dari dalam tangki air.



5 Gulung kabel listrik di sekeliling bodi alat.

## Mengatasi masalah

Bab ini berisi ringkasan masalah yang paling umum ditemui terkait alat. Jika Anda tidak dapat mengatasi masalah dengan mengacu pada informasi di bawah, kunjungi [www.philips.com/support](http://www.philips.com/support) untuk mengetahui daftar pertanyaan yang sering diajukan atau hubungi Pusat Layanan Konsumen di negara Anda.

Masalah	Kemungkinan penyebab	Solusi
Setrika tidak dapat menghilangkan kerutan pada pakaian.	Uap tidak keluar saat menyetrica.	Isi tangki air dan atur tombol geser uap ke  .
Setrika tidak mengeluarkan uap sama sekali.	Air di dalam tangki tidak cukup.	Isi tangki air.
	Tombol geser uap diatur ke  .	Atur tombol geser uap ke  .

	Setrika belum cukup panas untuk mengeluarkan uap.	Saat setrika sedang dipanaskan, lampu "setrika siap" akan terus menyala. Saat setrika siap digunakan, lampu akan mati.
Air menetes pada pakaian saat menyetrika.	Anda terlalu sering menggunakan fungsi semburan uap dalam waktu singkat.	Teruskan menyetrika pada posisi horizontal dan tunggu sebentar sebelum Anda menggunakan kembali fungsi semburan uap.
	Tangki air belum ditutup dengan benar.	Tekan tutupnya sampai terdengar bunyi 'klik'.
Setrika tidak mengeluarkan semburan uap.	Anda terlalu sering menggunakan fungsi semburan uap dalam waktu singkat.	Teruskan menyetrika pada posisi horizontal dan tunggu sebentar sebelum Anda menggunakan kembali fungsi semburan uap.
	Setrika belum cukup panas untuk menyetrika.	Tunggu hingga lampu 'setrika siap' berhenti berkedip dan terus menyala.
	Bahan kimia dimasukkan ke dalam tangki air.	Bilas tangki air dan jangan masukkan pewangi pakaian atau bahan kimia apa pun ke dalam tangki air.
Air menetes dari tapak setrika setelah steker dicabut.	Tombol geser uap diatur ke  .	Atur tombol geser uap ke  .
	Setrika diletakkan pada posisi horizontal ketika masih ada sisa air di dalam tangki.	Kosongkan tangki air setelah digunakan atau simpan setrika pada posisi vertikal.
Setrika meninggalkan kilap atau bekas setrika pada pakaian.	Permukaan yang akan disetrika tidak rata, misalnya karena Anda menyetrika di atas keliman atau lipatan pakaian.	Setrika aman digunakan pada semua pakaian yang dapat disetrika. Kilap atau bekas setrika tidak bersifat permanen dan akan hilang setelah pakaian dicuci. Jangan menyetrika di atas keliman atau lipatan pakaian. Anda juga bisa mengalasi area yang akan disetrika dengan kain katun agar tidak meninggalkan bekas setrika.

# Pengenalan

Tahniah atas pembelian anda dan selamat menggunakan Philips! Untuk mendapatkan manfaat sepenuhnya daripada sokongan yang ditawarkan oleh Philips, daftar produk anda di [www.philips.com/welcome](http://www.philips.com/welcome). Baca manual pengguna ini, risalah maklumat penting dan panduan permulaan ringkas dengan teliti sebelum anda menggunakan perkakas. Simpan untuk rujukan masa hadapan.

## Gambaran keseluruhan produk

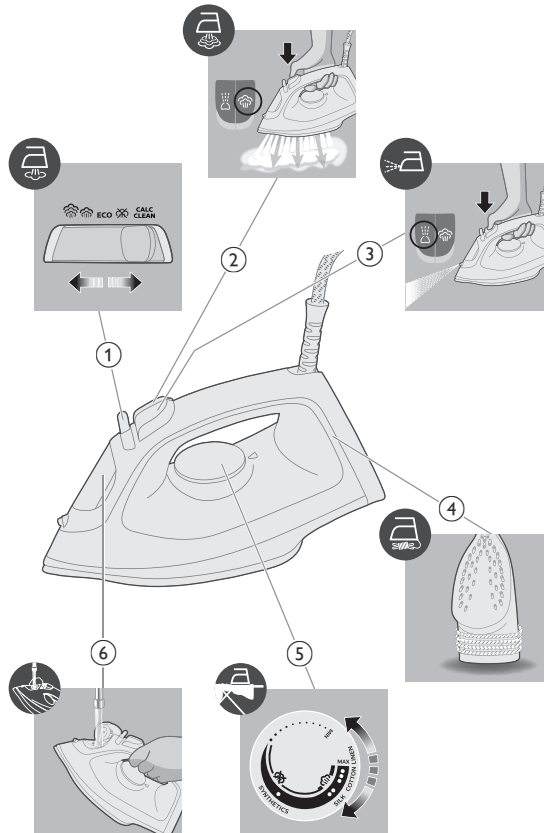

- 1 Pemilih stim
- 2 Butang penggalak stim
- 3 Penyembur air
- 4 Menggulung kord
- 5 Tombol suhu
- 6 Penutup tangki air

## Menggunakan perkakas

### Bersedia untuk menggunakan

Nota: Seterika mungkin mengeluarkan sedikit stim apabila anda menggunakannya buat kali pertama. Stim akan berhenti setelah seketika.

#### Jenis air untuk digunakan

Perkakas sesuai untuk digunakan dengan air paip. Walau bagaimanapun, jika anda tinggal di kawasan dengan air liat, kami menasihatkan agar anda mencampurkan air paip dengan air suling atau air tanpa mineral dalam jumlah yang sama. Langkah ini akan menghalang pembentukan karat yang cepat dan memanjangkan hayat perkakas anda.

**Jangan tambahkan pewangi, air dari mesin pengering pakaian, cuka, kanji, agen penyahkerak, bahan bantu penyeterikaan, air dinyahkerak secara kimia atau bahan kimia lain kerana bahan ini boleh menyebabkan air tersembur, kesan kotoran perang atau kerosakan pada perkakas anda.**

### Mengisi tangki air

- 1 Jangan pasang palam perkakas.

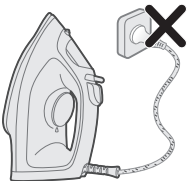

2 Pastikan perkakas telah menyejuk.

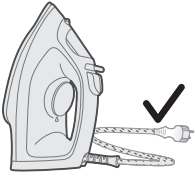

3 Leret pemilih stim ke kanan untuk memilih mod tiada stim (penyeterikaan kering) ~~☒~~.

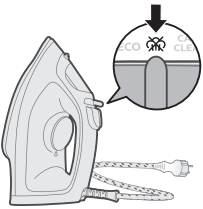

4 Selak buka tudung tangki air.

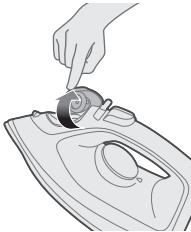

5 Isikan tangki air sehingga penunjuk MAX dalam tangki air.

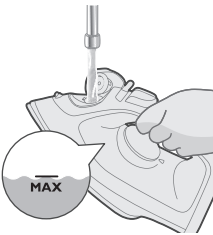

6 Tutup penutup tangki air dengan ketat.

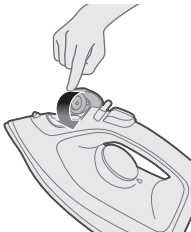

## Menetapkan suhu



	MAX LINEN	
	● ● ● KAIN KAPAS	
	● ● SUTERA	<b>ECO</b>
	● SINTETIK	



Tetapan ECO: Stim berterusan yang minimum akan dikeluarkan secara berterusan untuk pakaian dengan sedikit kedutan. Tetapan ini turut menjimatkan tenaga.



Dua gumpalan stim: Lebih banyak stim berterusan akan dikeluarkan secara berterusan untuk kedutan degil.



Tiga gumpalan awan: Stim berterusan yang maksimum akan dikeluarkan secara berterusan untuk kedutan degil.

## Menggunakan perkakas

1 Semak label pakaian tentang penyeterikaan yang diperlukan.

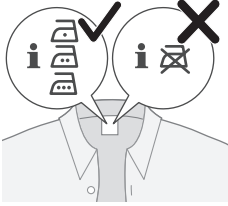

2 Tetapkan tombol suhu pada suhu penyeterikaan yang dikehendaki dengan memutarkannya ke kedudukan yang betul.

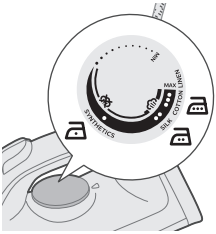

3 Biarkan seterika didirikan pada tumitnya.

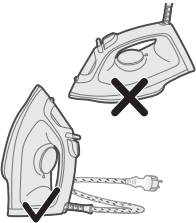

4 Pasangkan palam perkakas kepada soket dinding yang dibumikan.

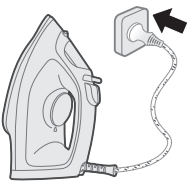

5 Lampu seterika sedia akan menyala untuk menandakan seterika sedang memanas.

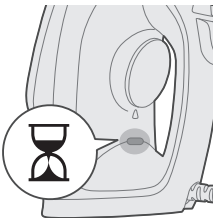

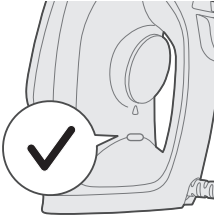

- 6 Apabila lampu seterika sedia telah padam, tunggu sebentar sebelum anda mula menyeterika. Lampu sedia akan bernyala dari semasa ke semasa.

## Tiada stim/Penyeterikaan kering

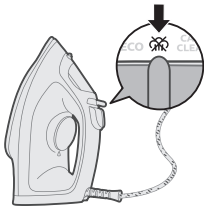

- 1 Tetapkan tetapan stim kepada tetapan tiada stim.

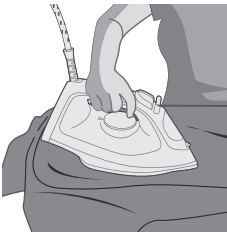

- 2 Selepas seketika, stim akan berhenti semasa proses penyeterikaan.

## Penyembur air

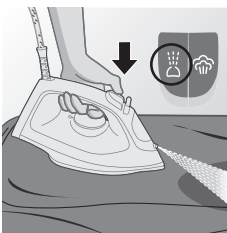

- 1 Tetapkan tetapan stim kepada tetapan tiada stim. Tekan dan tahan butang penyembur air untuk mengeluarkan stim bagi menghilangkan kedutan yang degil.



## Penggalak stim

- 1 Tetapkan tombol suhu kepada tetapan MAX antara kapas dan linen.

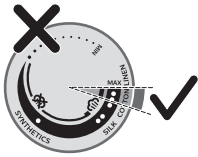

- 2 Tekan dan lepaskan butang penggalak stim untuk pancutan stim yang kuat untuk menghilangkan kedutan yang degil.



- 3 Anda juga boleh menggunakan fungsi penggalak stim apabila anda memegang seterika dalam kedudukan menegak untuk menghilangkan kedutan daripada pakaian yang digantung (untuk DST2020 dan DST2030 sahaja).

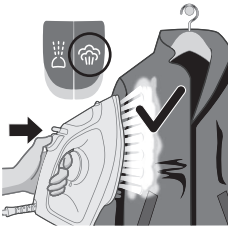

- 4 Tarik dan regangkan pakaian anda sambil menggunakan penggalak stim untuk menghilangkan kedutan yang degil (untuk DST2020 dan DST2030 sahaja).

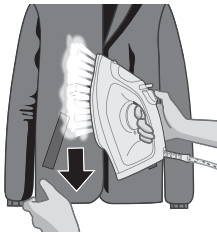

- 5 Jangan gunakan tangan anda sebagai permukaan sokongan semasa anda menyeterika.



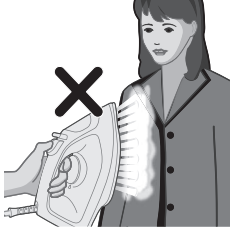

6 Jangan halakan perkakas ke arah diri anda/orang lain.

## Mod automati (DST2030)



1 Untuk memberi anda ketenangan fikiran, perkakas akan menyejukkan sendiri jika dibiarkan tanpa pengawasan untuk suatu tempoh masa.

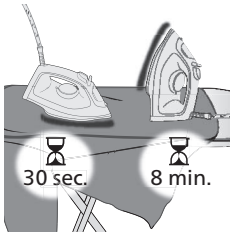
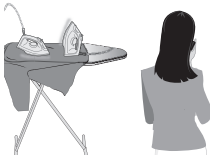

2 Apabila perkakas tidak digunakan lebih daripada 30 saat dan dibiarkan mendatar di atas plat tapak atau didirikan selama 8 minit, perkakas akan memasuki mod automati.

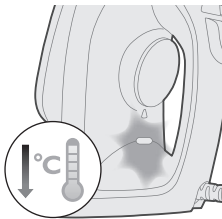

3 Suhu perkakas akan berkurangan dalam mod pematian automatik. Lampu seterika sedia juga akan bernyala untuk menandakan bahawa perkakas berada dalam mod pematian automatik. Untuk mematikan perkakas sepenuhnya, cabut palam perkakas daripada soket.

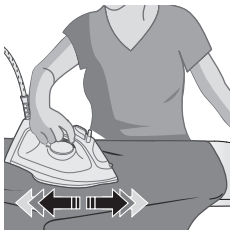

4 Untuk menjadikan perkakas panas semula, angkat perkakas atau gerakkannya sedikit.

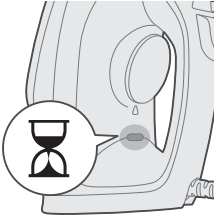

5 Lampu seterika sedia akan menyala, menandakan perkakas sedang memanas.

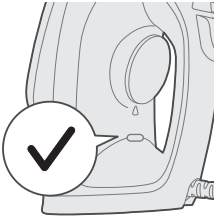

6 Setelah lampu seterika sedia padam, perkakas sedia digunakan.

## Pembersihan dan penyelenggaraan

1 Pastikan perkakas tidak dipasang.

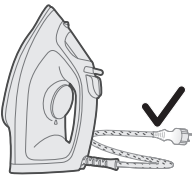
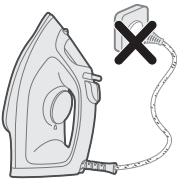

2 Pastikan perkakas telah menyejuk.

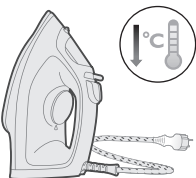

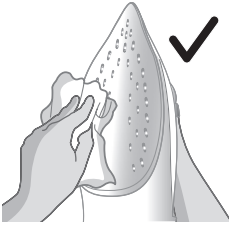

- 3 Lap kepingan dan sisa lain di plat tapak dengan kain lembap.



Nota: Untuk memastikan plat tapak licin, elakkan daripada tersentuh dengan kuat dengan bahan logam. Jangan sekali-kali menggunakan pad penyental, cuka atau bahan kimia lain untuk membersihkan tapak plat.



- 4 Jangan cuci/bersihkan berus di bawah air yang mengalir.

## Pembersihan Kerak

Petua: Fungsi Pelepas Kerak Pantas boleh digunakan pada bila-bila masa. Jika air di kawasan anda sangat liat, gunakan fungsi ini dengan lebih kerap.



- 1 Selepas digunakan selama 1 bulan, anda disyorkan agar melakukan pembersihan kerak untuk membuang kerak yang terkumpul daripada perkakas anda untuk memanjangkan hayat seterika dan memastikan perkakas menjadi panas.

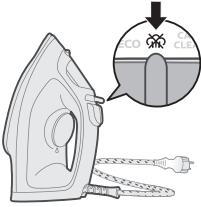

2 Pastikan seterika dicabut palam dan tetapan stim ditetapkan kepada mod tiada stim (penyeterikaan kering) .

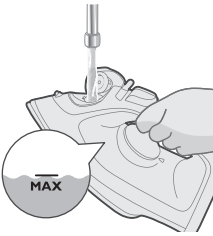

3 Isikan tangki air sehingga penunjuk MAX.

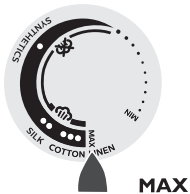

4 Tetapkan suhu tombol kepada MAX.

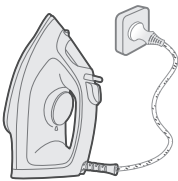

5 Sambungkan perkakas kepada soket dinding yang dibumikan.

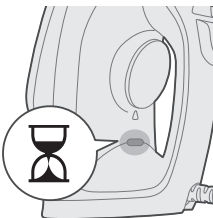

6 Lampu seterika sedia akan menyala, menandakan perkakas sedang memanas.

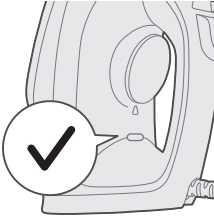

7 Tunggu sehingga lampu seterika sedia padam.

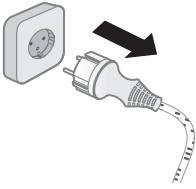

8 Cabut palam seterika.

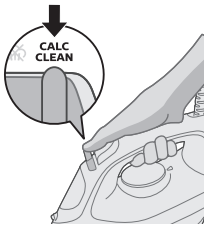

9 Luncurkan pemilih stim kepada kedudukan Pembersihan Kerak dan tahan.



10 Pegang seterika di atas singki dan goyangkan seterika perlahan-lahan. Air panas dan partikel kerak akan dilepaskan dari plat tapak.

Awas: Apabila kerak dikumbah keluar, stim dan air yang mendidih akan turut keluar daripada plat tapak.

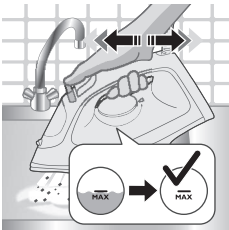

11 Terus goyangkan seterika dengan perlahan sehingga semua air di dalam tangki air habis dikeluarkan.

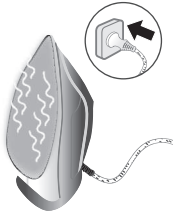

- 12 Pasangkan plag perkakas dan biarkan perkakas menjadi panas supaya plat tapak menjadi kering. Proses ini mengambil masa lebih kurang 2 minit.

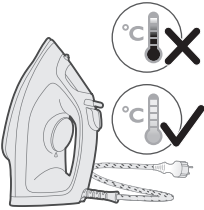

- 13 Biarkan seterika menyejuk.

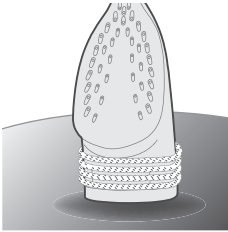

- 14 Lilitkan kord kuasa di sekeliling tumit seterika.

## Penyimpanan

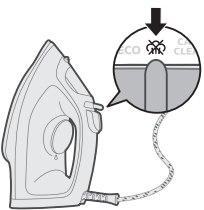

- 1 Leret pemilih stim ke kanan untuk memilih mod tiada stim (penyeterikaan kering) ~~ON~~.

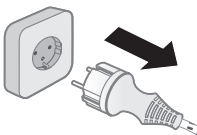

- 2 Cabut palam perkakas.

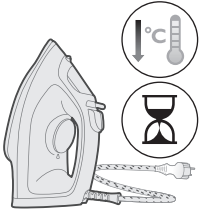

3 Biarkan perkakas itu menyejuk.

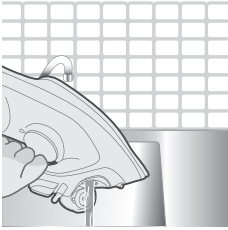

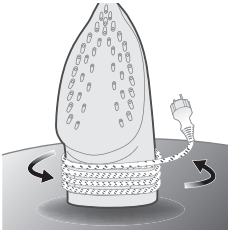

4 Tuang lebihan baki air keluar dari tangki air.



5 Lilitkan kord kuasa di sekeliling bahagian utama perkakas.

## Penyelesaian masalah

Bab ini meringkaskan masalah paling lazim yang anda hadapi dengan perkakas. Jika anda tidak dapat menyelesaikan masalah dengan maklumat di bawah, lawati [www.philips.com/support](http://www.philips.com/support) untuk mendapatkan senarai soalan lazim atau hubungi Pusat Layanan Pelanggan di negara anda.

Masalah	Penyebab yang mungkin	Penyelesaian
Seterika tidak dapat menghilangkan kedutan daripada pakaian.	Tiada stim semasa menyeterika.	Isi tangki air dan tetapkan peluncur stim kepada  .
Seterika tidak menghasilkan stim.	Air di dalam tangki tidak mencukupi.	Isi tangki air.
	Peluncur stim telah ditetapkan kepada  .	Tetapkan peluncur stim kepada  .



	Seterika masih tidak cukup panas untuk menghasilkan stim.	Apabila seterika sedang dipanaskan, lampu "seterika sedia" akan beryala dengan stabil. Apabila seterika sedia untuk digunakan, lampu akan mati.
Titisan air menitik pada pakaian semasa menyeterika.	Anda telah menggunakan fungsi penggalak terlalu kerap dalam tempoh masa yang pendek.	Terus menyeterika dalam kedudukan mendatar dan tunggu seketika sebelum anda kembali menggunakan fungsi penggalak stim.
	Anda tidak menutup tudung tangki air dengan betul.	Tekan tudungnya sehingga anda mendengar bunyi 'klik'.
Seterika tidak mengeluarkan pancutan stim.	Anda telah menggunakan fungsi penggalak stim terlalu kerap dalam tempoh masa yang pendek.	Terus menyeterika dalam kedudukan mendatar dan tunggu seketika sebelum anda kembali menggunakan fungsi penggalak stim.
	Seterika tidak cukup panas untuk menyeterika.	Tunggu sehingga lampu 'seterika sedia' berhenti berkelip dan terus menyala.
	Anda telah memasukkan bahan kimia ke dalam tangki air.	Bilas tangki air dan jangan masukkan sebarang pewangi atau bahan kimia ke dalam tangki air.
Air menitis dari tapak setelah palam seterika dicabut.	Peluncur stim telah ditetapkan kepada  .	Tetapkan peluncur stim kepada  .
	Anda telah meletakkan seterika dalam kedudukan mendatar dengan air masih tertinggal di dalam tangki air.	Kosongkan tangki air selepas penggunaan atau simpan seterika dalam kedudukan menegak.
Seterika meninggalkan kilatan atau kesan pada pakaian.	Permukaan yang hendak diseterika tidak rata, contohnya anda menyeterika di atas kelim atau lipatan pada pakaian.	Seterika selamat untuk digunakan pada semua pakaian yang boleh diseterika. Kilatan atau kesan ini tidak kekal dan akan hilang setelah pakaian dicuci. Elakkan menyeterika di atas kelim atau lipatan. Anda juga boleh meletakkan kain kapas di atas kawasan yang hendak diseterika untuk mengelakkan kesan.

# Úvod

Gratulujeme k nákupu a vítáme vás mezi uživateli výrobků společnosti Philips! Chcete-li využívat všech výhod podpory nabízené společností Philips, zaregistrujte svůj výrobek na stránkách [www.philips.com/welcome](http://www.philips.com/welcome). Před použitím přístroje si pečlivě tuto uživatelskou příručku, leták s důležitými informacemi a stručnou příručku. Uschovejte je pro budoucí použití.

## Přehled výrobku

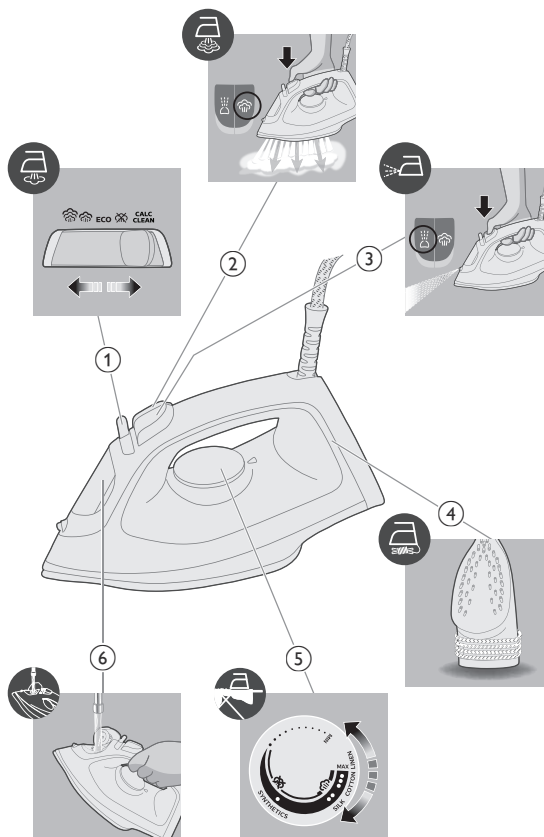

- 1 Volič páry
- 2 Tlačítko parního rázu
- 3 Kropení
- 4 Navíjení šňůry
- 5 Volič teploty
- 6 Víko nádržky na vodu

## Použití přístroje

### Příprava k použití

Poznámka: Při prvním použití může z žehličky unikat slabá pára. Brzy to však přestane.

#### Typ použitelné vody

Přístroj je určen pro použití s vodou z kohoutku. Pokud však žijete v oblasti s tvrdou vodou, doporučujeme smíchat stejné množství vody z vodovodu s destilovanou nebo demineralizovanou vodou. Zabráníte tak rychlému usazování vodního kamene a prodloužíte životnost přístroje.

**Nepřidávejte parfém, vodu ze sušičky, ocet, škrob, odvápnovací prostředky, přípravky pro usnadnění žehlení, vodu s chemicky odstraněným vodním kamenem nebo jiné chemikálie, protože by mohlo dojít k vystřikování, vzniku hnědých skvrn nebo poškození zařízení.**

### Naplnění nádržky na vodu

- 1 Přístroj nezapojte do zásuvky.

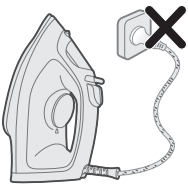

2 Ujistěte se, že přístroj vychladl.

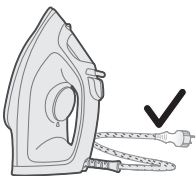

3 Posuňte voličem páry doprava a vyberte režim bez páry (suché žehlení) .

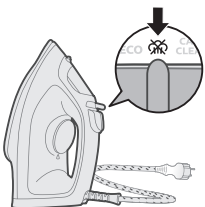

4 Odklopte víko nádržky na vodu.

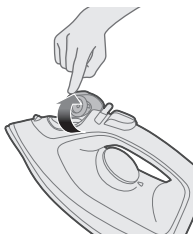

5 Zásobník naplňte vodou až po označení MAX.

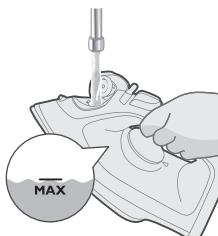

6 Pevně zavřete víčko nádržky na vodu.

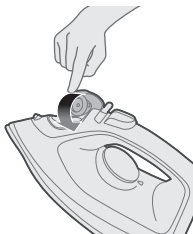

## Nastavení teploty



	MAX LEN	
	● ● ● BAVLNA	
	● ● HEDVÁBÍ	<b>ECO</b>
	● SYNTECKÉ TKANINY	



Nastavení ECO: Na oděvy s menším množstvím záhybů se nepřetržitě konstantně aplikuje minimální množství páry. Toto nastavení také šetří energii.



Dva obláčky páry: Na odolné záhyby se nepřetržitě konstantně aplikuje větší množství páry.



Tři obláčky páry: Na nejdolnější záhyby se nepřetržitě konstantně aplikuje maximální množství páry.

## Použití přístroje

- 1 Požadovaný režim žehlení si ověřte na cedulce žehleného prádla.

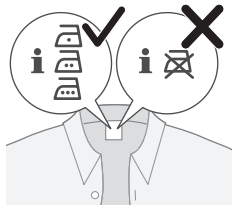

- 2 Otočením regulátoru teploty nastavte požadovanou teplotu.

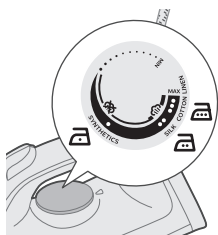

- 3 Žehličku nechte položenou na zadní straně.

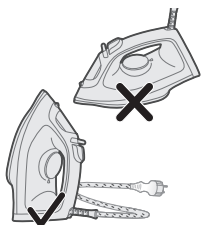

- 4 Přístroj zapojte do řádně uzemněné zásuvky.

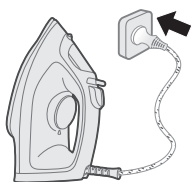

- 5 Rozsvítí se kontrolka „žehlička připravena“, což znamená, že se žehlička zahřívá.

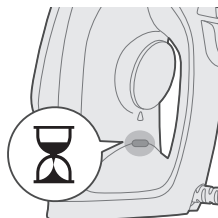

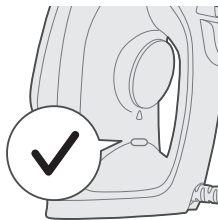

- 6 Když kontrolka „žehlička připravena“ zhasne, ještě chvíli před začátkem žehlení počkejte. Kontrolka „žehlička připravena“ se během žehlení čas od času rozsvítí.

## Bez páry / suché žehlení

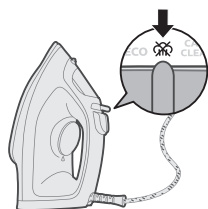

- 1 Posuňte voličem páry a vyberte režim „bez páry“.

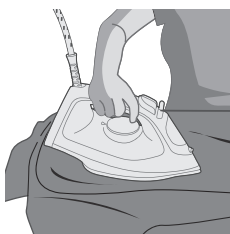

- 2 Pára během žehlení brzy ustane.

## Kropení



- 1 Posuňte voličem páry a vyberte režim „bez páry“. Stisknutím a uvolněním tlačítka kropení získáte proud vodní mlhy pro odstranění nepoddajných záhybů.

## Parní ráz

- 1 Nastavte volič teploty do pozice MAX mezi bavlnou a lnem.

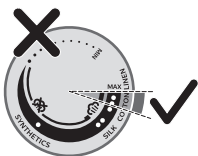

- 2 Stisknutím a uvolněním tlačítka parního rázu získáte silný parní ráz pro odstranění nepoddajných záhybů.



- 3 Funkci parního rázu lze také použít, držíte-li žehličku ve svislé poloze. To je užitečné při odstraňování záhybů u pověšených oděvů (pouze modely DST2020 a DST2030).



- 4 Během aplikace parního rázu pro odstranění nejodolnějších záhybů oděv jemně napínejte a natahujte (pouze modely DST2020 a DST2030).

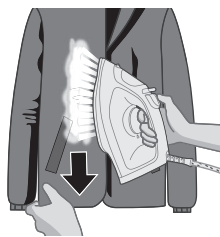

- 5 Při žehlení oděv nepodpírejte holýma rukama.





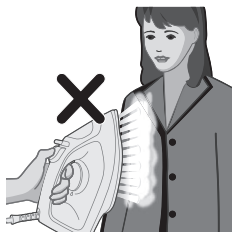

6 Nemiřte přístroj na sebe ani jinou osobu.

## Režim automatického vypnutí (DST2030)



1 Pokud přístroj ponecháte delší dobu bez dozoru, můžete být klidní, protože vychladne sám.

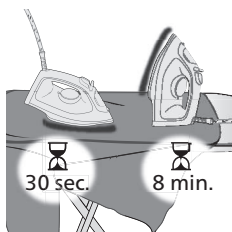

2 Když přístroj nepoužíváte a ponecháte ho položený na žehlicí ploše po dobu delší než 30 sekund nebo na podstavci/základně po dobu 8 minut, automaticky se vypne.

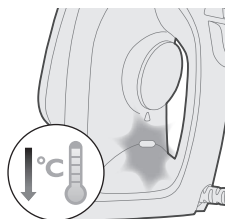

3 V režimu automatického vypnutí teplota přístroje klesne. Kontrolka „žehlička připravena“ začne také nepřetržitě blikat, což znamená, že je přístroj ve stavu automatického vypnutí. Chcete-li přístroj úplně vypnout, vypojte jej ze zásuvky.

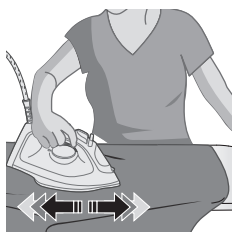

4 Chcete-li žehličku znovu zahřát, zvedněte ji nebo s ní lehce pohněte.

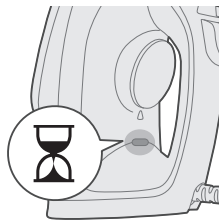

5 Rozsvítí se kontrolka „žehlička připravena“, která signalizuje, že se přístroj zahřívá.

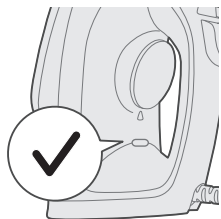

6 Když kontrolka „žehlička připravena“ zhasne, přístroj je připraven k použití.

## Čištění a údržba

1 Ujistěte se, že přístroj není připojen do sítě.

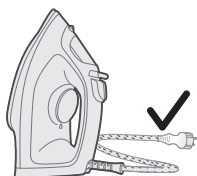
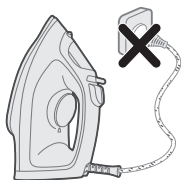

2 Ujistěte se, že přístroj vychladl.

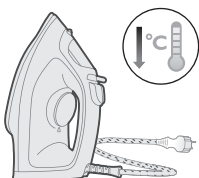



- 3 Vlhkým hadříkem otřete vložky a jiné usazeniny z žehlicí plochy.

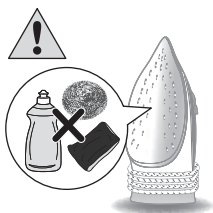

Poznámka: Aby zůstala žehlicí plocha hladká, chraňte ji před přímým kontaktem s kovovými předměty. K čištění žehlicí plochy nikdy nepoužívejte kovovou žínku, ocet nebo jiné chemikálie.

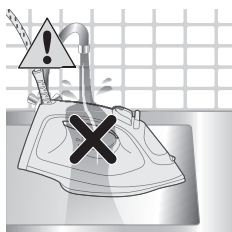

- 4 Příklad nemyjte/nečistěte pod tekoucí vodou.

## Funkce Calc-Clean

Tip: Funkci rychlého odstranění vodního kamene Quick Calc je možné použít kdykoli. Pokud žijete v oblasti s tvrdou vodou, používejte tuto funkci častěji.



- 1 Po jednom měsíci používání se doporučuje provést čištění vodního kamene, aby se z přístroje odstranil usazený vodní kámen, prodloužila se jeho životnost a aby bylo zajištěno, že se bude zahřívat.

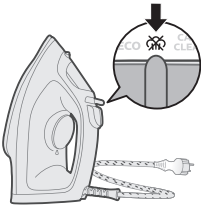

2 Zajistěte, aby byla žehlička odpojena a aby byl volič páry posunutý na režim „bez páry“ (suché žehlení) .

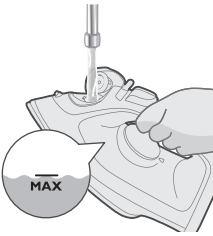

3 Nádržku na vodu naplňte vodou až po označení MAX.



4 Nastavte regulátor teploty na MAX.

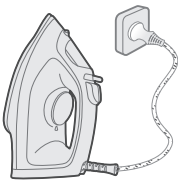

5 Příklad zapojte do řádně uzemněných zásuvek.

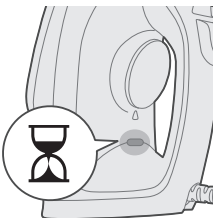

6 Rozsvítí se kontrolka „žehlička připravena“, která signalizuje, že se přístroj zahřívá.

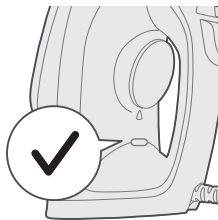

7 Vyčkejte, až kontrolka „žehlička připravena“ zhasne.

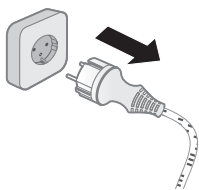

8 Žehličku odpojte.

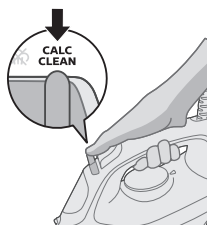

9 Posuňte volič páry do polohy Calc-Clean a přidržte jej.



10 Držte žehličku nad dřezem a jemně s ní třeste. Ze žehlicí plochy vyteče horká voda s kousky vodního kamene.

Upozornění: Během vyplavování vodního kamene vychází z žehlicí plochy také pára a vroucí voda.

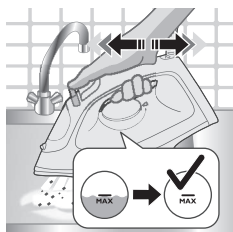

11 Třeste žehličkou do té doby, dokud z nádrčky nevyteče veškerá voda.

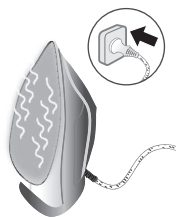

**12** Zapojte žehličku a nechte ji zahřát, aby žehlicí plocha oschla. Tento proces trvá přibližně 2 minuty.

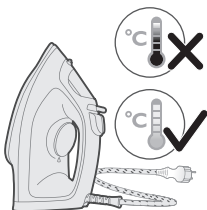

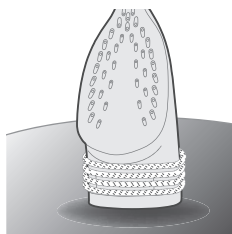

**13** Nechte žehličku vychladnout.

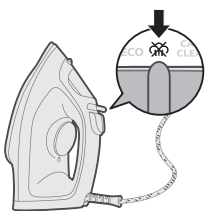

**14** Kabel obtočte kolem spodní části žehličky.

## Skladování



**1** Posuňte voličem páry a vyberte režim bez páry (suché žehlení) .

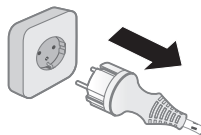

**2** Odpojte přístroj z napájení.

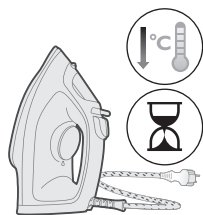

3 Nechte přístroj vychladnout.

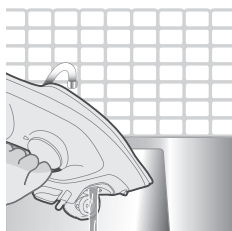

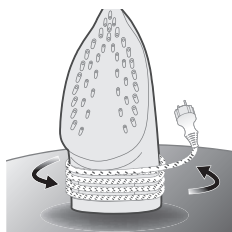

4 Vylijte veškerou zbývající vodu z nádržky.



5 Napájecí kabel obtočte kolem hlavního těla přístroje.

## Odstraňování potíží

V této kapitole najdete nejběžnější problémy, s nimiž se můžete u přístroje setkat. Pokud se vám nepodaří problém vyřešit s pomocí následujících informací, navštivte webové stránky [www.philips.com/support](http://www.philips.com/support), kde naleznete seznam nejčastějších dotazů, nebo se obraťte na středisko péče o zákazníky ve své zemi.

Problém	Možná příčina	Řešení
Žehlička neodstraňuje záhyby na oděvu.	Během žehlení nedochází ke tvorbě páry.	Naplňte nádržku na vodu a nastavte posuvník páry do polohy  .
Přístroj nevytváří žádnou páru.	V nádržce není dostatek vody.	Naplňte nádržku na vodu.
	Posuvník páry je v poloze  .	Nastavte posuvník páry do polohy  .

	Teplota žehličky dosud nepostačuje k vytvoření páry.	Zatímco se žehlička zahřívá, rozsvítí se kontrolka „žehlička připravena“. Kontrolka zhasne, když je žehlička připravena k použití.
Během žehlení stékají na oděv kapičky vody.	Funkci parního rázu jste používali příliš často během krátké doby.	Pokračujte v žehlení ve vodorovné poloze a určitou dobu počkejte, než znovu použijete funkci parního rázu.
	Nezavřeli jste řádně víko nádržky.	Stlačte víčko, dokud neuslyšíte zaklapnutí.
Žehlička nevytváří parní ráz.	Funkci parního rázu jste používali příliš často během krátké doby.	Pokračujte v žehlení ve vodorovné poloze a určitou dobu počkejte, než znovu použijete funkci parního rázu.
	Žehlička ještě není dostatečně zahřátá.	Počkejte, až kontrolka „žehlička je připravena“ přestane blikat a rozsvítí se.
	Přidali jste do nádržky na vodu chemikálii.	Vyláchněte nádržku na vodu a nedávejte do ní žádné chemikálie.
Po odpojení žehličky z žehlicí plochy vytékají kapky vody.	Posuvník páry je v poloze  .	Nastavte posuvník páry do polohy  .
	Žehlička byla uložena ve vodorovné poloze a v zásobníku zůstala voda.	Po použití vyprázdňte nádržku na vodu nebo žehličku umístěte do vzpřímené polohy.
Žehlička nechává na oděvu lesklé stopy nebo otisky.	Žehlený povrch nebyl rovný, například proto, že jste žehličkou přejížděli šev nebo záhyb látky.	Žehličku je bezpečné používat na všech typech tkaniny. Potisk nebo zářivé efekty nejsou trvalé a při praní oblečení mizí. Nežehlete švy ani sklady. Na žehlenou tkaninu můžete položit bavlněnou látku, aby žehlička nezanechala stopy.



# Indledning

Tillykke med dit køb, og velkommen til Philips! Hvis du vil have fuldt udbytte af den support, som Philips tilbyder, kan du registrere dit produkt på [www.philips.com/welcome](http://www.philips.com/welcome). Læs denne brugervejledning, folderen med vigtige oplysninger og lynhåndbogen omhyggeligt igennem, inden apparatet tages i brug. Gem dem til senere brug.

## Produktoversigt

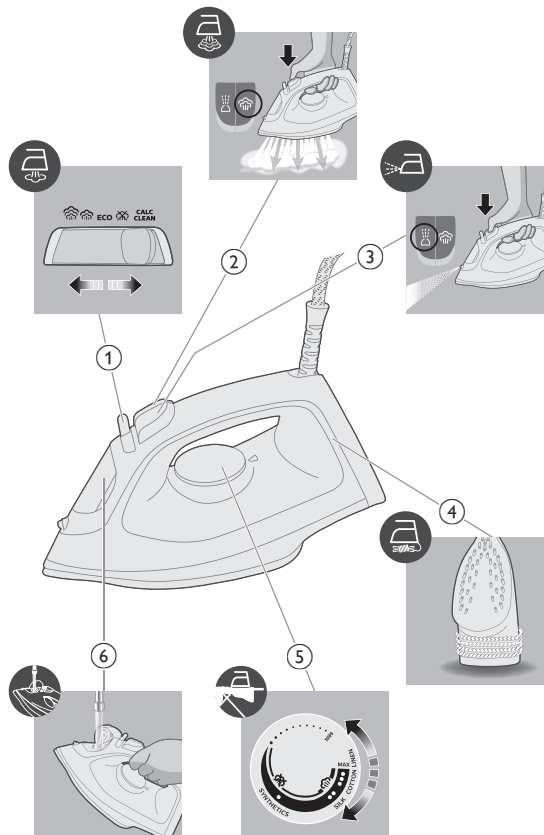

- 1 Dampvælger
- 2 Knap til dampskud
- 3 Vandspray
- 4 Ledningsvikling
- 5 Temperaturvælger
- 6 Låg til vandtank

## Sådan bruges apparatet

### Klargøring

Bemærk: Strygejernet kan afgive lidt damp, når det tages i brug første gang. Dette stopper efter kort tid.

#### Type af vand, der skal bruges

Apparatet er velegnet til brug med postevand. Hvis du bor i et område med hårdt vand, anbefaler vi dog, at du blander lige dele postevand og destilleret eller demineraliseret vand. Dette vil forhindre hurtig kalkaflejring og forlænge apparatets levetid.

**Tilsæt ikke parfume, vand fra en tørretumbler, eddike, stivelse, afkalkningsmiddel, strygemiddel, kemisk afkalket vand eller andre kemikalier, da de kan medføre vandstænk, brune pletter eller skader på apparatet.**

### Påfyldning af vandtanken

- 1 Tilslut ikke apparatet.

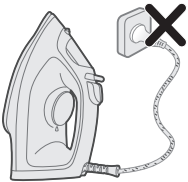

- 2 Kontrollér, at apparatet er kølet af.

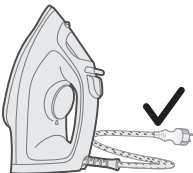

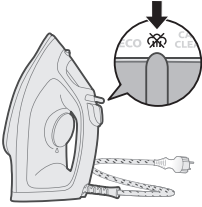

3 Skub dampvælgeren til højre for at vælge ingen damp-indstillingen (tørstrygning) .

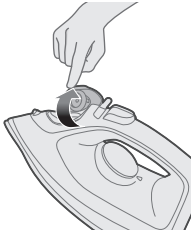

4 Åbn låget til vandtanken.

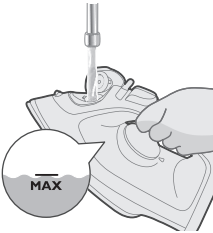

5 Fyld vandtanken op til MAX-markeringen i vandtanken.

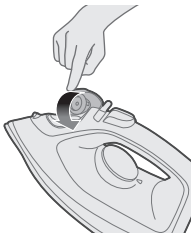

6 Luk vandtankens låg korrekt.

## Temperaturindstilling



MAX  
HØR



● ● ●  
BOMULD



● ●  
SILKE

ECO

●  
KUNSTSTOF

ECO



ECO-indstilling: Der leveres kontinuerligt et minimum af damp til stoffer med færre folder. Denne indstilling sparer samtidig energi.



To dampskyer: Der leveres mere kontinuerligt maksimal damp til genstridige folder.



Tre dampskyer: Der leveres kontinuerligt maksimal damp til vanskelige folder.

## Sådan bruges apparatet

- 1 Kontrollér vaskemærket for at se den korrekte indstilling til stryging.

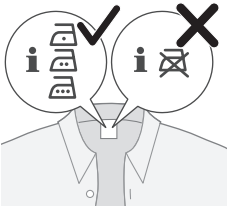

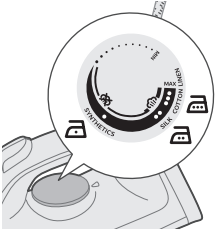

2 Drej temperaturvælgeren til den ønskede strygetemperatur.

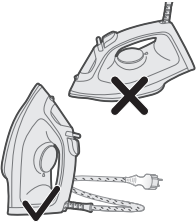

3 Lad strygejernet stå på højkant.

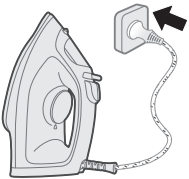

4 Sæt stikket ind i en stikkontakt med jord.

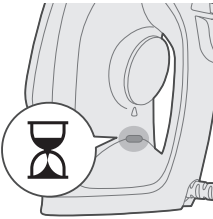

5 Indikatoren for "Strygejernet er klar" lyser for at angive, at strygejernet varmer op.

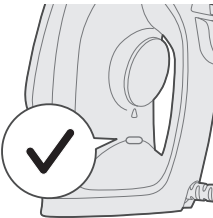

6 Når indikatoren for "Strygejernet er klar", skal du vente et øjeblik, inden du begynder at stryge. Indikatoren tænder fra tid til anden under strygningen.

## Ingen damp/tørstrygning

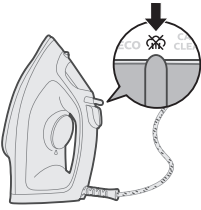

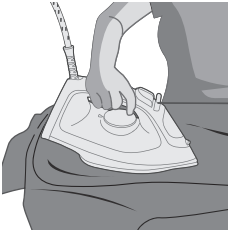

1 Indstil apparatet til ingen damp-indstillingen.

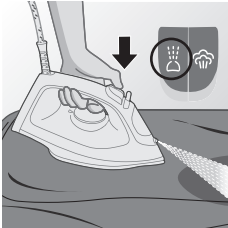

2 Efter kort tid vil dampen ophøre under strygningen.

## Vandspray



1 Indstil apparatet til ingen damp-indstillingen. Tryk på og slip vandsprayknappen  for at få en strøm af væskestøv, der kan fjerne vanskelige folder.

## Dampskud

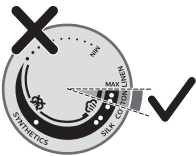

1 Drej temperaturvælgeren til MAX-indstillingen mellem bomuld og hør.

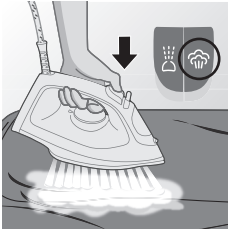

2 Tryk på og slip dampskudsknappen for at få et effektivt dampskud, der fjerner vanskelige folder.

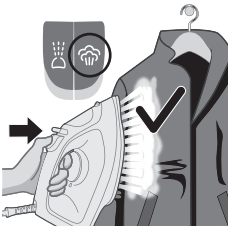

3 Dampskudsfunktionen kan også anvendes, når strygejernet holdes i en lodret position for at fjerne folder fra hængende tøj (kun til DST2020 og DST2030).

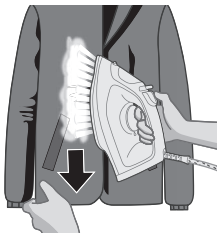

4 Træk og stræk dit tøj, mens du anvender dampskud til at fjerne vanskelige folder (kun til DST2020 og DST2030).



5 Brug ikke din bare hånd som støtteflade, når du stryger.

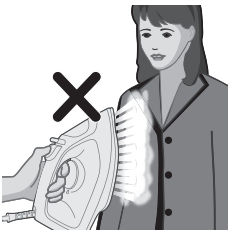

6 Placer ikke apparatet mod dig selv/en anden person.

## Auto-sluk (DST2030)



- 1 For at give dig ro i sinde tøl apparatet ned af sig selv, hvis det efterlades uden opsyn i et stykke tid.

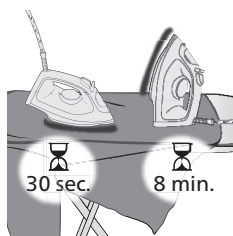

- 2 Når apparatet ikke er i brug i mere end 30 sekunder, når det står på strygesålen, eller 8 minutter, når det står oprejst, slukker det automatisk.

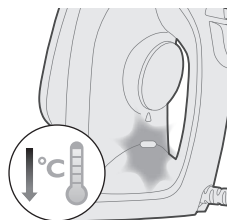

- 3 Apparatets temperatur vil falde i auto-sluk-tilstand. Indikatoren for "Strygejernet er klar" blinker også uafbrudt for at angive, at apparatet er i auto-sluk-tilstand. For at slukke helt for apparatet skal du tage stikket ud af stikkontakten.

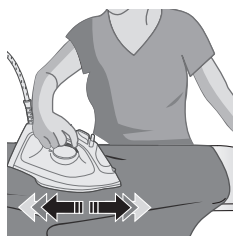

- 4 Løft apparatet, eller bevæg det en lille smule for få strygejernet til at varme op igen.

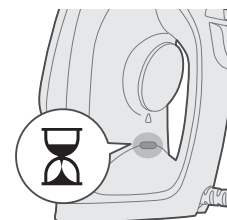

- 5 Indikatoren for strygejernet er klar lyser for at angive, at apparatet varmer op.



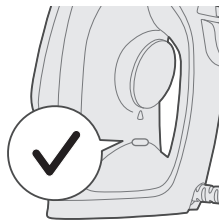

6 Når indikatoren for strygejernet er klar slukker, er apparatet klar til brug.

## Rengøring og vedligeholdelse

1 Kontrollér, at apparatet er ikke sat i stikkontakten.

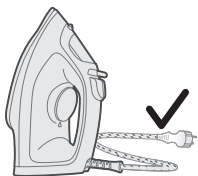
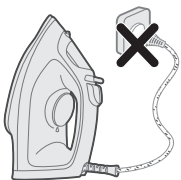

2 Kontrollér, at apparatet er kølet af.

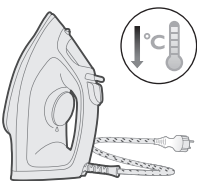

3 Aftør flager og andet bundfald af strygesålen med en fugtig klud.





Bemærk: Undgå kontakt med metalgenstande, så strygesålen bevares glat. Anvend aldrig skuremidler, eddike eller andre kemikalier for at rengøre strygesålen.

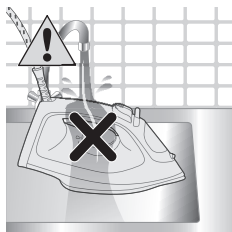

4 Apparatet må ikke vaskes/rengøres under rindende vand.

## Calc-Clean



Tip: Quick Calc Release-funktionen kan bruges når som helst. Hvis du bor i et område med hårdt vand, skal du bruge funktionen oftere.

1 Efter 1 måneds brug anbefales det at foretage en Calc Clean-rensning for at fjerne aflejringer fra apparatet for at forlænge dets levetid og sikre, at det varmer op.

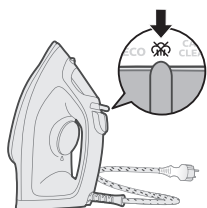

2 Kontrollér, at strygejernet er taget ud af stikkontakten, og at dampindstillingen er indstillet til ingen damp (tørstrygning) .

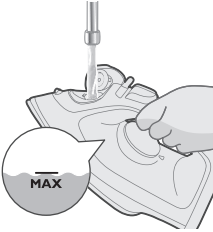

3 Fyld vand i vandtanken til MAX-markeringen.



4 Indstil temperaturvælgeren på MAX.

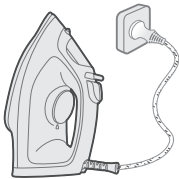

5 Slut apparatet til en stikkontakt med jordforbindelse.

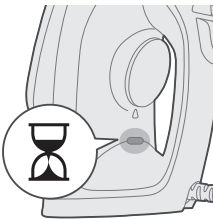

6 Indikatoren for strygejernet er klar lyser for at angive, at apparatet varmer op.

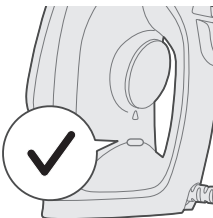

7 Vent, indtil indikatoren for "Strygejernet er klar" slukker.

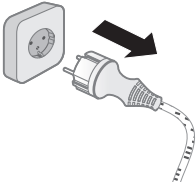

8 Tag stikket ud af stikkontakten.

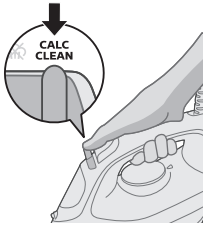

9 Skub dampvælgeren til Calc-Clean-positionen, og hold den.



10 Hold strygejernet hen over vasken, og ryst det forsigtigt. Varmt vand og kalkpartikler vil blive udledt fra strygesålen.

Forsigtig: Mens kalkpartiklerne skylles ud, kommer der også damp og kogende vand ud af strygesålen.

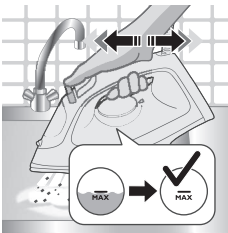

11 Fortsæt med at ryste strygejernet, indtil vandtanken er tømt helt for vand.

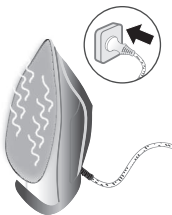

12 Sæt apparatets stik i stikkontakten, og varm apparatet op for at tørre strygesålen. Dette tager omkring to minutter.

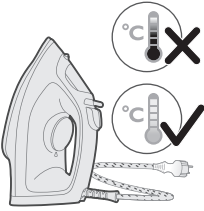

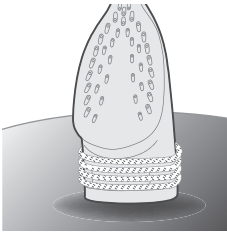

13 Lad strygejernet køle af.

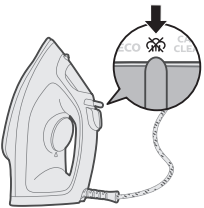

14 Rul ledningen rundt om strygejernets fod.

## Opbevaring



1 Skub dampvælgeren for at vælge ingen-damp-tilstand (tør stryging) .

2 Tag apparatet ud af stikkontakten.

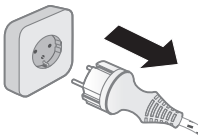

3 Lad apparatet afkøle.

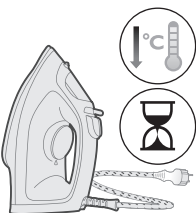

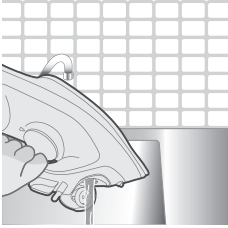

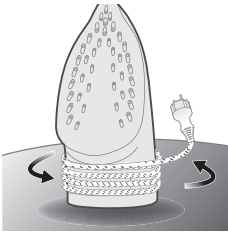

4 Hæld overskydende vand ud af vandtanken.





5 Rul strømledningen rundt om basisenheden.

## Fejlfinding

I dette kapitel beskrives de mest almindelige problemer, der kan opstå med dit apparat. Hvis du ikke kan løse problemet ved hjælp af nedenstående oplysninger, kan du se en liste over ofte stillede spørgsmål på [www.philips.com/support](http://www.philips.com/support). Du er også altid velkommen til at kontakte dit lokale Philips Kundecenter.

Problem	Mulig årsag	Løsning
Strygejernet kan ikke fjerne folder fra tøjet.	Der kommer ingen damp under strygningen.	Fyld vandtanken, og indstil dampskyderen til  .
Strygejernet producerer ingen damp.	Der er ikke vand nok i tanken.	Fyld vand i vandtanken.
	Dampskyderen står på  .	Indstil dampskyderen til  .
	Strygejernet er endnu ikke varmt nok til at producere damp.	Mens strygejernet varmer op, lyser indikatoren for strygejernet er klar konstant. Når strygejernet er klar til brug, slukker indikatoren.
Der drypper vand på tøjet under strygning.	Du har anvendt dampskudsfunktionen for ofte inden for en kort periode.	Fortsæt strygningen i vandret position, og vent lidt, før du bruger dampskudsfunktionen igen.
	Vandtankens låg er ikke lukket ordentligt.	Tryk på låget, til der høres et "klik".

<p>Strygejernet producerer ikke dampskud.</p>	<p>Du har anvendt dampskudsfunktionen for ofte inden for en kort periode.</p>	<p>Fortsæt strygningen i vandret position, og vent lidt, før du bruger dampskudsfunktionen igen.</p>
	<p>Strygejernet er endnu ikke varmt nok til strygning.</p>	<p>Vent, indtil indikatoren for "strygejernet er klar" stopper med at blinke og lyser konstant.</p>
	<p>Du har hældt et kemikalie i vandtanken.</p>	<p>Skyl vandtanken, og undlad at hælde parfume eller kemikalier i vandtanken.</p>
<p>Der drypper vand ud af strygesålen, efter at strygejernets stik er taget ud af stikkontakten.</p>	<p>Dampskyderen står på .</p>	<p>Indstil dampskyderen til .</p>
	<p>Strygejernet står vandret, og der er stadig vand i vandtanken.</p>	<p>Tøm vandtanken efter brug, eller hold strygejernet i lodret position.</p>
<p>Strygejernet efterlader glans eller mærker på stoffet.</p>	<p>Stoffets overflade var ujævn, f.eks. fordi du strøg oven på en søm eller en fold.</p>	<p>Strygejernet er sikkert at bruge på alt tøj, der tåler strygning. Glansen eller mærket er ikke permanent og forsvinder, når du vasker tøjet. Undgå at stryge hen over sømme og folder. Du kan også anbringe et stykke bomuldsstof over området, der skal stryges, for at undgå mærker.</p>

# Einführung

Herzlichen Glückwunsch zu Ihrem Kauf und willkommen bei Philips! Um das Kundendienstangebot von Philips vollständig nutzen zu können, sollten Sie Ihr Produkt unter [www.philips.com/welcome](http://www.philips.com/welcome) registrieren. Lesen Sie diese Betriebsanleitung, das wichtige Informationsblatt und die Schnellstartanleitung sorgfältig durch, bevor Sie das Gerät verwenden. Bewahren Sie sie zur späteren Verwendung auf.

## Produktübersicht

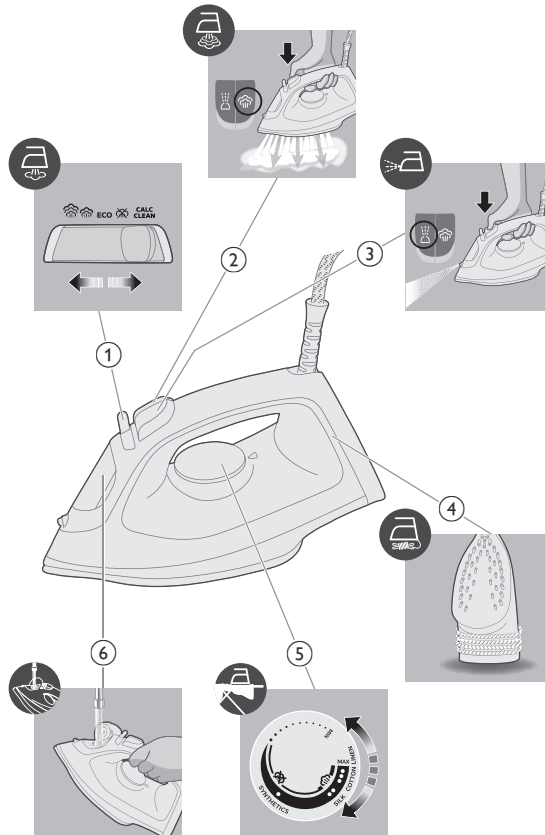



- 1 Dampfgregler
- 2 Dampfstoß-Taste
- 3 Wasserspray
- 4 Kabelaufwicklung
- 5 Temperaturregler
- 6 Deckel für Wasserbehälter

## Das Gerät benutzen

### Für den Gebrauch vorbereiten

Hinweis: Beim ersten Gebrauch kann das Bügeleisen etwas Dampf entwickeln. Dies stellt sich jedoch nach kurzer Zeit ein.

#### Zu verwendende Wasserart

Ihr Gerät kann mit Leitungswasser verwendet werden. Wenn Sie jedoch in einem Bereich mit hartem Wasser leben, empfehlen wir Ihnen, eine gleiche Menge Leitungswasser mit destilliertem oder entmineralisiertem Wasser zu mischen. Dadurch wird eine schnelle Kalkablagerung verhindert und die Lebensdauer des Geräts verlängert.

**Geben Sie kein Parfüm, Wasser aus dem Wäschetrockner, Essig, Stärke, Entkalkungsmittel, Bügelhilfsmittel, chemisch entkalktes Wasser oder andere Chemikalien hinzu, da dies zu Austreten von Wasser, braunen Flecken oder Schäden am Gerät führen kann.**

### Füllen des Wasserbehälters

- 1 Schließen Sie das Gerät nicht an.

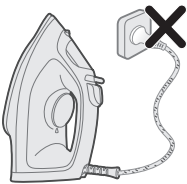

2 Stellen Sie sicher, dass das Gerät abgekühlt ist.

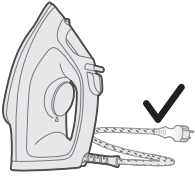

3 Schieben Sie den Dampfregler nach rechts, um den Modus ohne Dampf auszuwählen (trocken bügeln) ~~☁~~.

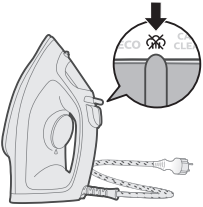

4 Öffnen Sie den Deckel des Wasserbehälters.

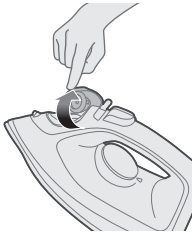

5 Füllen Sie den Wasserbehälter bis zur MAX-Markierung mit Wasser.

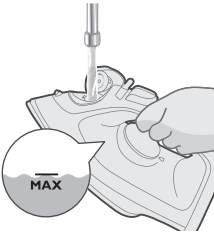

6 Schließen Sie den Deckel des Wasserbehälters fest.

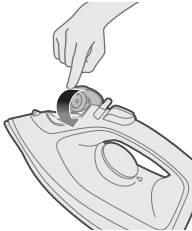

## Einstellen der Temperatur



	MAX LEINEN	
	● ● ● BAUMWOLLE	
	● ● SEIDE	<b>ECO</b>
	● SYNTHETIK	



ECO-Einstellung: Es wird kontinuierlich die minimale Dampfmenge für Kleidungsstücke mit wenig Falten ausgestoßen. Mit dieser Einstellung sparen Sie ebenfalls Energie.



Zwei Dampfwolken: Es wird kontinuierlich zusätzlicher Dampf für hartnäckige Falten ausgestoßen.

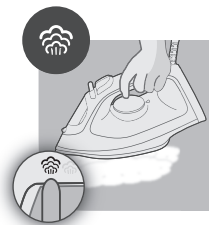

Drei Dampfwolken: Es wird kontinuierlich die maximale Dampfmenge für sehr hartnäckige Falten ausgestoßen.

## Das Gerät benutzen

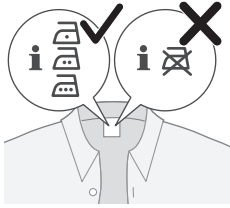

- 1 Überprüfen Sie das Etikett des Kleidungsstücks auf die Anweisungen zum Bügeln.

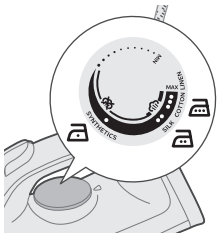

- 2 Stellen Sie den Temperaturregler auf die gewünschte Bügeltemperatur ein, indem Sie ihn in die entsprechende Richtung drehen.

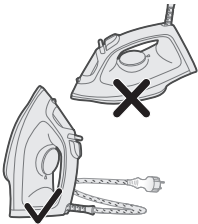

- 3 Stellen Sie das Bügeleisen aufrecht ab.

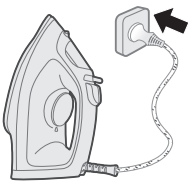

- 4 Schließen Sie das Gerät an eine geerdete Steckdose an.

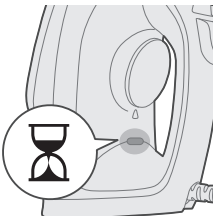

- 5 Die Bereitschaftsanzeige leuchtet auf, um anzuzeigen, dass das Bügeleisen aufgeheizt wird.

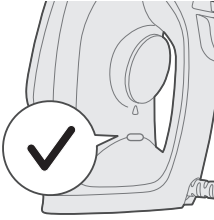

- 6 Wenn die Bereitschaftsanzeige des Bügeleisens erlischt, warten Sie einen Moment, bevor Sie mit dem Bügeln beginnen. Die Bereitschaftsanzeige leuchtet während des Bügelns gelegentlich auf.

## Kein Dampf/Trocken bügeln

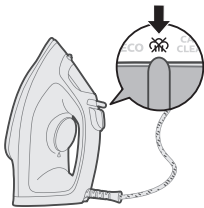

- 1 Stellen Sie "Kein Dampf" ein.

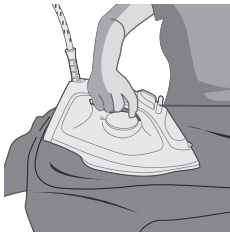

- 2 Nach kurzer Zeit wird der Dampfstoß während des Bügelns eingestellt.

## Wasserspray

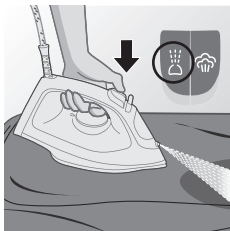

- 1 Stellen Sie "Kein Dampf" ein. Drücken Sie die Wassersprühstaste  und lassen Sie sie wieder los, um hartnäckige Falten durch einen Sprühstoß zu entfernen.

## Dampfstoß

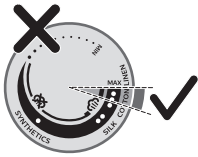

- 1 Stellen Sie den Temperaturregler auf die MAX-Einstellung zwischen Baumwolle und Leinen.



- 2 Drücken Sie die Dampfstoß-Taste und lassen Sie sie wieder los, um durch den kräftigen Dampfstoß hartnäckige Falten zu glätten.

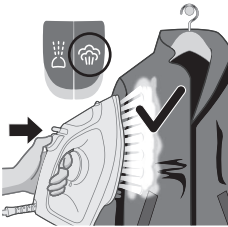

- 3 Die Dampfstoß-Funktion kann auch bei senkrecht gehaltenem Bügeleisen eingesetzt werden. Diese Funktion eignet sich besonders zum Glätten von hängenden Kleidungsstücken (nur für DST2020 und DST2030).

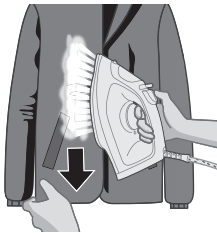

- 4 Ziehen und straffen Sie Ihr Kleidungsstück während der Dampfstöße, um hartnäckige Falten zu entfernen (nur für DST2020 und DST2030).



- 5 Verwenden Sie während des Bügelns Ihre bloße Hand nicht als stützende Unterlage.

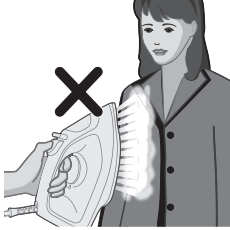

- 6 Richten Sie das Gerät nicht auf sich selbst oder eine andere Person.

## Automatische Abschaltung (DST2030)

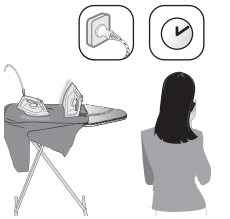

- 1 Zu Ihrer Sicherheit kühlt sich das Gerät selbst ab, wenn es für eine gewisse Zeit unbeaufsichtigt bleibt.

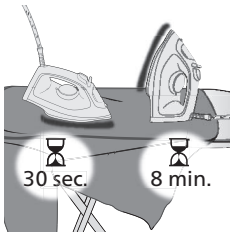

- 2 Wenn das Gerät länger als 30 Sekunden auf der Bügelsohle oder 8 Minuten auf der Standfläche/Basis steht und nicht verwendet wird, wechselt es in die automatische Abschaltung.

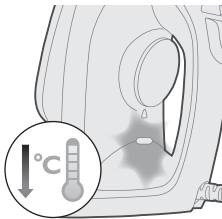

- 3 Die Temperatur des Geräts sinkt während der automatischen Abschaltung. Die Bereitschaftsanzeige blinkt kontinuierlich, um anzuzeigen, dass sich das Gerät in der automatischen Ausschaltfunktion befindet. Um das Gerät vollständig auszuschalten, ziehen Sie den Netzstecker aus der Steckdose.

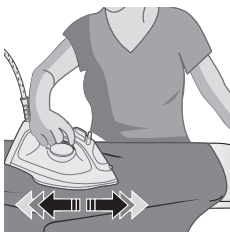

- 4 Um das Bügeleisen wieder aufheizen zu lassen, heben Sie es an, oder bewegen Sie es leicht.

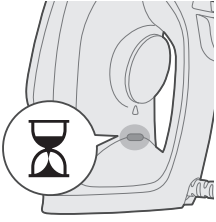

5 Die Bereitschaftsanzeige leuchtet auf, und zeigt an, dass das Gerät sich aufheizt.

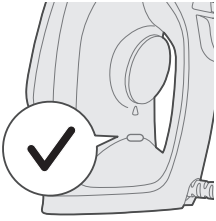

6 Sobald die Bereitschaftsanzeige erlischt, ist das Gerät einsatzbereit.

## Reinigung und Wartung

1 Stellen Sie sicher, dass das Gerät nicht an das Stromnetz angeschlossen ist.

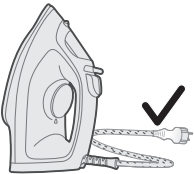
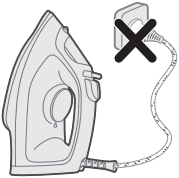

2 Stellen Sie sicher, dass das Gerät abgekühlt ist.

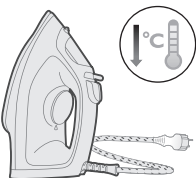



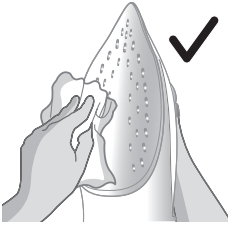

- 3 Wischen Sie Flocken und andere Ablagerungen mit einem feuchten Tuch von der Bügelsohle ab.



Hinweis: Damit die Bügelsohle glatt bleibt, sollte sie nicht mit Metallgegenständen in Berührung kommen. Verwenden Sie zur Reinigung der Bügelsohle niemals Scheuerschwämme, Essig oder Chemikalien.

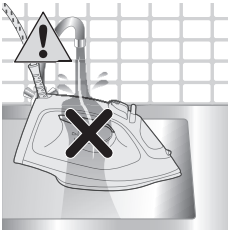

- 4 Waschen/Reinigen Sie das Gerät nicht unter fließendem Wasser.

## Calc-Clean-Funktion

Tipp: Die Quick Calc Release-Funktion kann jederzeit verwendet werden. Wenn Sie in einer Region mit hartem Wasser leben, sollten Sie die Funktion häufiger anwenden.



- 1 Es wird empfohlen, nach 1 Monat in Verwendung die Calc-Clean-Funktion auszuführen, um Kalk aus Ihrem Gerät zu entfernen. So wird seine Lebensdauer verlängert und sichergestellt, dass es sich weiterhin aufheizt.

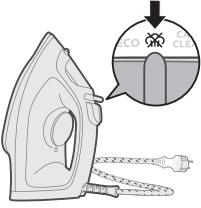

2 Stellen Sie sicher, dass das Bügeleisen nicht angeschlossen und der Modus ohne Dampf eingestellt ist (trocken bügeln) .

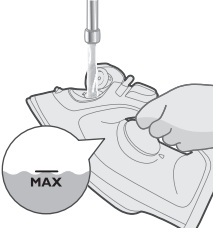

3 Füllen Sie den Wasserbehälter bis zur MAX-Markierung mit Wasser.



4 Stellen Sie den Temperaturregler auf MAX.

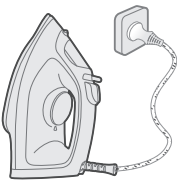

5 Schließen Sie das Gerät an eine geerdete Steckdose an.

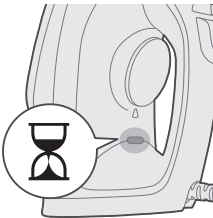

6 Die Bereitschaftsanzeige leuchtet auf, und zeigt an, dass das Gerät sich aufheizt.

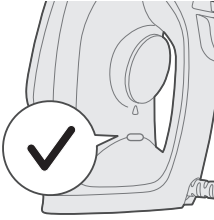

7 Warten Sie, bis die Bereitschaftsanzeige erlischt.

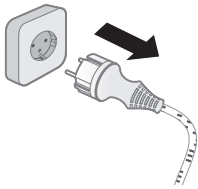

8 Ziehen Sie den Netzstecker des Bügeleisens aus der Steckdose.

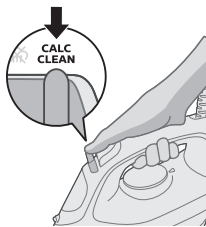

9 Schieben Sie den Dampfgregler auf die Calc-Clean-Position und halten Sie ihn gedrückt.



10 Halten Sie das Bügeleisen über das Spülbecken und schütteln Sie es vorsichtig. Aus der Bügelsohle treten heißes Wasser und Kalkpartikel aus.

Achtung: Während Kalkpartikel herausgespült werden, entweichen auch Dampf und kochendes Wasser aus der Bügelsohle.

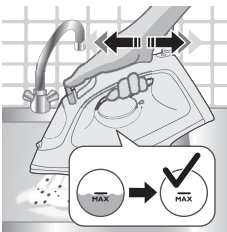

11 Schütteln Sie das Bügeleisen weiterhin sanft, bis der Wasserbehälter vollständig leer ist.

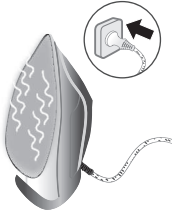

**12** Schließen Sie das Gerät an, und lassen Sie es aufheizen, damit die Bügelsohle trocknet. Dies nimmt ungefähr 2 Minuten in Anspruch.

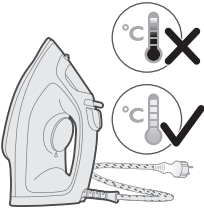

**13** Lassen Sie das Bügeleisen abkühlen.

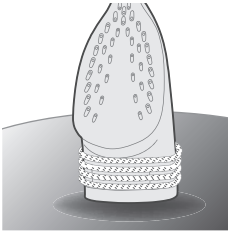

**14** Wickeln Sie das Netzkabel hinten um das Bügeleisen.

## Aufbewahrung

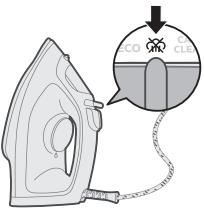

**1** Verschieben Sie den Dampfregler, um den Modus ohne Dampf auszuwählen (trocken bügeln) ~~☒~~.

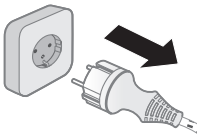

**2** Ziehen Sie den Netzstecker aus der Steckdose.

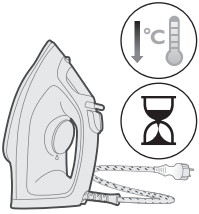

3 Lassen Sie das Gerät abkühlen.

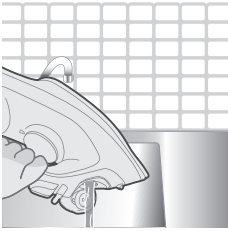

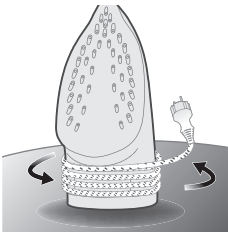

4 Gießen Sie verbleibendes Wasser aus dem Wasserbehälter.



5 Wickeln Sie das Netzkabel um das Hauptgehäuse des Geräts.

## Fehlerbehebung

In diesem Kapitel sind die häufigsten Probleme aufgeführt, die beim Gebrauch Ihres Geräts auftreten können. Sollten Sie ein Problem mithilfe der nachstehenden Informationen nicht beheben können, besuchen Sie unsere Website unter [www.philips.com/support](http://www.philips.com/support), auf der Sie eine Liste mit häufig gestellten Fragen finden, oder wenden Sie sich an das Service-Center in Ihrem Land.

Problem	Mögliche Ursache	Lösung
Das Bügeleisen kann keine Falten aus dem Kleidungsstück entfernen.	Während des Bügelns wird kein Dampf abgegeben.	Füllen Sie den Wasserbehälter, und stellen Sie den Dampfschieberegler auf  .
Das Bügeleisen erzeugt keinen Dampf.	Es befindet sich nicht genug Wasser im Wasserbehälter.	Füllen Sie den Wasserbehälter.
	Der Dampfschieberegler ist auf  eingestellt.	Stellen Sie den Dampfschieberegler auf die Position  .

	Das Bügeleisen ist noch nicht heiß genug, um Dampf zu erzeugen.	Während das Bügeleisen aufheizt, leuchtet die Bereitschaftsanzeige dauerhaft. Wenn das Bügeleisen betriebsbereit ist, erlischt die Anzeige.
Wasser tropft beim Bügeln auf das Kleidungsstück.	Sie haben die Boost-Funktion zu oft innerhalb zu kurzer Zeit verwendet.	Bügeln Sie eine Zeit lang mit waagrecht gehaltenem Bügeleisen weiter, bevor Sie die Dampfstoß-Funktion erneut betätigen.
	Sie haben den Deckel des Wasserbehälters nicht richtig geschlossen.	Drücken Sie auf den Deckel, bis er hörbar einrastet.
Das Bügeleisen gibt keinen Dampfstoß ab.	Sie haben die Dampfstoß-Funktion zu oft innerhalb zu kurzer Zeit verwendet.	Bügeln Sie eine Zeit lang mit waagrecht gehaltenem Bügeleisen weiter, bevor Sie die Dampfstoß-Funktion erneut betätigen.
	Das Bügeleisen ist noch nicht heiß genug zum Bügeln.	Warten Sie, bis die Bereitschaftsanzeige aufhört zu blinken und durchgehend leuchtet.
	Sie haben eine Chemikalie in den Wasserbehälter gegeben.	Spülen Sie den Wasserbehälter aus, und geben Sie kein Parfum und keine Chemikalien in den Wasserbehälter.
Wasser tropft aus der Bügelsohle, nachdem das Bügeleisen von der Stromversorgung getrennt wird.	Der Dampfschieberegler ist auf  eingestellt.	Stellen Sie den Dampfschieberegler auf die Position  .
	Sie haben das Bügeleisen waagrecht abgestellt, und es war noch Wasser im Wasserbehälter.	Leeren Sie den Wasserbehälter nach jedem Gebrauch, oder bewahren Sie das Bügeleisen in senkrechter Position auf.
Das Bügeleisen hinterlässt auf dem Stoff glänzende Stellen oder einen Abdruck.	Die zu bügelnde Oberfläche war uneben, z. B. weil Sie auf dem Stoff über einer Naht oder einer Falte gebügelt haben.	Das Bügeleisen kann auf allen bügelechten Kleidungsstücken verwendet werden. Der Glanz bzw. der Abdruck ist nicht von Dauer und verschwindet beim Waschen. Bügeln Sie, wenn möglich, nicht über Nähte oder Falten. Legen Sie ein Baumwolltuch auf den Bügelbereich, um Abdrücke zu vermeiden.

# Tutvustus

Õnnitleme ostu puhul ja tervitame Philipsi poolt! Philipsi pakutava tootetoe eeliste täielikuks kasutamiseks registreerige oma toode veebilehel [www.philips.com/welcome](http://www.philips.com/welcome). Enne seadme kasutamist lugege hoolikalt käesolevat kasutusjuhendit, olulist teabelehte ja kiirkasutusjuhendit. Hoidke see edaspidiseks alles.

## Toote ülevaade

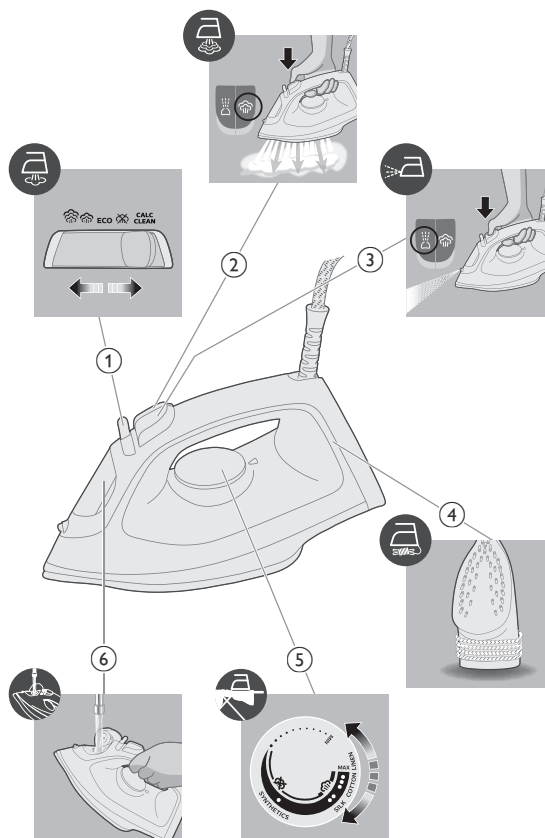

- 1 Auru valimine
- 2 Lisaauru nupp
- 3 Vee pihustamine
- 4 Toitejuhtme kerija
- 5 Temperatuuri ketasregulaator
- 6 Veenõu kaas

## Seadme kasutamine

### Kasutamiseks valmistumine

Märkus. Triikraud võib välja anda auru, kui kasutate seda esimest korda. See kaob mõne aja möödudes.

#### Kasutatava vee tüüp

Seadmes võib kasutada kraanivett. Kui elate kareda veega piirkonnas, soovitame teil segada võrdses koguses kraanivett destilleeritud või demineraliseeritud veega. See hoiab ära katlakivi kiire moodustumise ja pikendab seadme tööiga.

**Märkus: ärge kasutage veepaagis parfüümi, trummelkuivatist pärinevat vett, äädikat, tärklist, katlakivieemaldusvahendit, triikimist hõlbustavaid vahendeid, keemiliselt katlakivist puhastatud vett ega muid kemikaale, kuna need võivad tekitada veepritsmeid, pruune plekke või seadet kahjustada.**

### Veepaagi täitmine

- 1 Ärge ühendage seadet vooluvõrku.

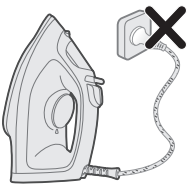

- 2 Veenduge, et seade on jahtunud.

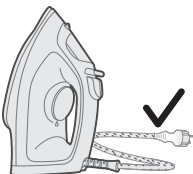



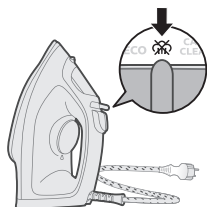

3 Libistage auruvalijat paremale, et valida aururežiim (kuiv triikimine) .

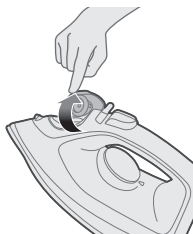

4 Keerake veepaagi kaas lahti.

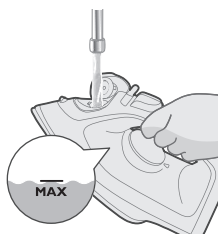

5 Täitke veepaak veega MAX-tähiseni.

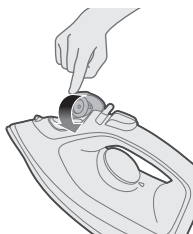

6 Sulgege veenõu kaas kindlalt.

## Temperatuuri seadistamine



MAX  
LINANE



● ● ●  
PUUVILLANE



**ECO**

SIID



SÜNTEETILINE

**ECO**

ECO-seade: Kergemate kortsude eemaldamiseks väljutatakse pidevalt minimaalset auru. See seadistus säästab ka energiat.



Kaks aurupilve: Tugevate kortsude eemaldamiseks väljutatakse pidevalt maksimaalset auru.



Kolm aurupilve: Maksimaalne püsiv aur väljutatakse pidevalt kangekaelseste kortsude jaoks.

## Seadme kasutamine

1 Kontrollige pesusildilt esemete nõutud triikimist.

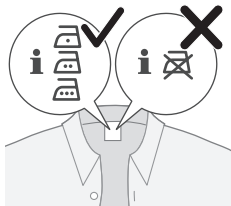

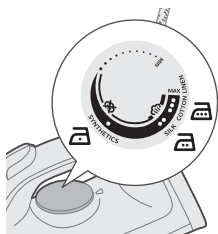

- 2 Seadke temperatuuriregulaator nõutud triikimistemperatuurile, pöörates selle vastavale temperatuuriseadele.

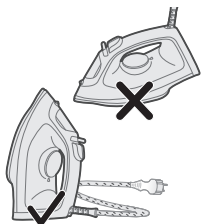

- 3 Laske triikimisraual kannale toetuda.

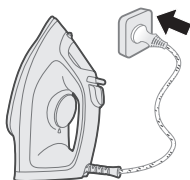

- 4 Ühendage seade maandatud pistikupesaga.

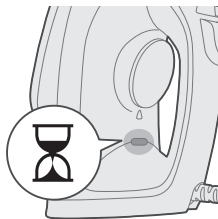

- 5 Märkutuli „triikraud valmis“ süttib, mis näitab, et raud soojeneb.

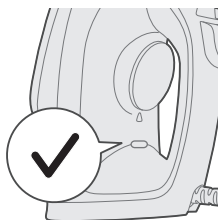

- 6 Pärast temperatuurivalmiduse märgutule kustumist oodake natuke, enne kui hakkate triikima. Triikimise ajal süttib märgutuli aeg-ajalt.

## Ilma auruta/Kuiv triikimine

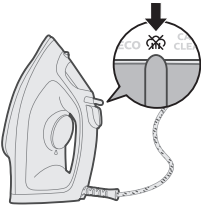

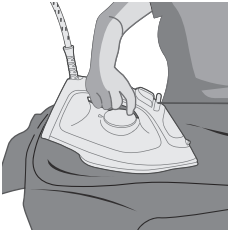

- 1 Seadistage auru seadistus ilma auruta seadistusele.

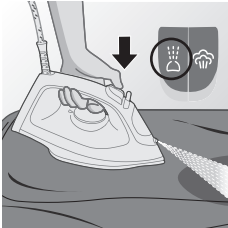

- 2 Mõne aja pärast lakkab triikimisel aur.

## Vee pihustamine



- 1 Seadistage auru seadistus ilma auruta seadistusele. Vajutage ja vabastage piserdusnupp  uduvoolu jaoks, et eemaldada visad kortsud.

## Lisaaur

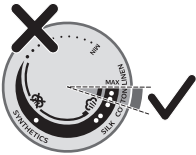

- 1 Seadistage temperatuurivalija MAX-i seadistusele puuvilla ja lina vahel.



2 Tugevate kortsude eemaldamiseks vajaliku võimsa auruvoo saamiseks vajutage lisaauru nuppu ja vabastage see.



3 Lisaauru funktsiooni võite rakendada püstasendis triikraual kortsude eemaldamiseks rippuvatelt rõivastelt (ainult mudelitele DST2020 ja DST2030).

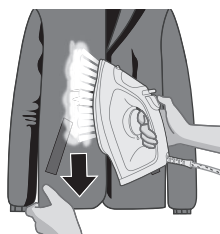

4 Tõmmake ja venitage rõivast, rakendades samal ajal aurutõmmet, et eemaldada visad kortsud (ainult mudelitele DST202X ja DST203X).



5 Ärge kasutage triikimise ajal tugipinnana paljast kätt.

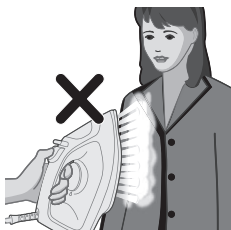

6 Ärge asetage seadet enda/teise inimese poole.

## Automaatne väljalülitus (DST2030)

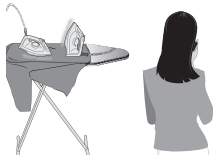

- 1 Andmaks teile meelerahu, on seade võimeline ise jahtuma, kui see jäetakse mõneks ajaks järelevalveta.

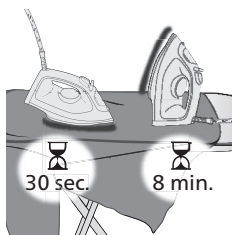

- 2 Kui seadet ei kasutata rohkem kui 30 sekundit, toetudes tallale või 8 minutit, toetudes kannale/alusele, lülitub seade automaatsesse väljalülitusrežiimi.

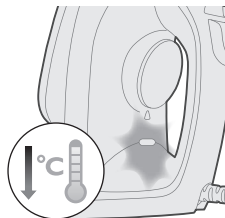

- 3 Seadme temperatuur alaneb automaatse väljalülitamise režiimis. Märgutuli „triikraud valmis“ valgub kogu aeg, et näidata, et seade on automaatses väljalülitusolekus. Seadme täielikuks väljalülitamiseks eemaldage seade pistikupesast.

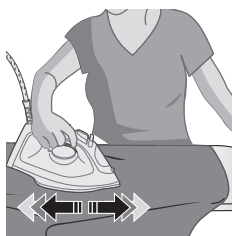

- 4 Selleks et seade hakkaks uuesti kuumenema, tõstke seadet või liigutage seda natuke.

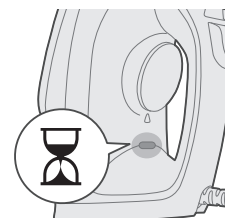

- 5 Märgutuli „triikraud valmis“ märgutuli süttib, mis näitab, et seade soojeneb.

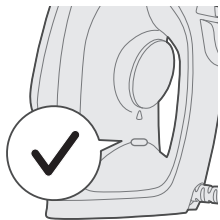

6 Kui märgutuli „triikraud valmis“ on kustunud, on seade kasutamiseks valmis.

## Puhastamine ja korrashoid

1 Veenduge, et toitekaabel ei ole vooluvõrku ühendatud.

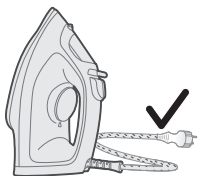
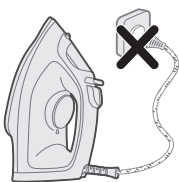

2 Veenduge, et seade on jahtunud.

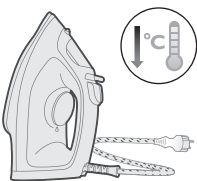

3 Pühkige helbed ja muu tallaplaadilt niiske lapiga.

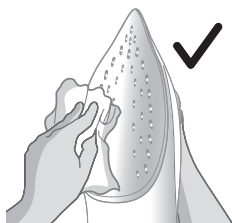



Märkus. Selleks, et hoida tald siledana, ärge puudutage seda metallesemetega! Ärge kunagi kasutage küürimiskäsna, äädikat või muid keemilisi vahendeid talla puhastamiseks.

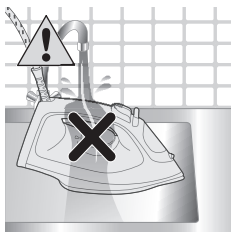

- 4 Ärge peske/puhastage seadet voolava vee all.

## Katlakivi eemaldamine

Nõuanne: Quick Calc Release'i funktsioon saab kasutada igal ajal. Kui elate kohas, kus vesi on kare, kasutage funktsiooni sagedamini.



- 1 Pärast 1 kuu kasutamist on soovitatav teha katlakivieemaldus, et eemaldada seadmelt katlakivi, et pikendada selle eluiga ja tagada seadme kuumenemine.

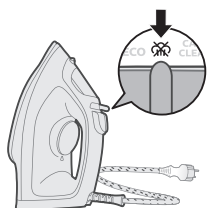

- 2 Veenduge, et triikraud on lahti ühendatud ja auruseade on seadistatud ilma aurrežiimiga (kuiv triikimine) .



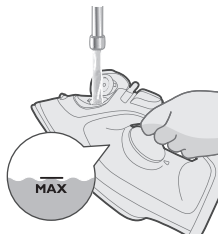

3 Täitke veepaak veega MAX-tähiseni.

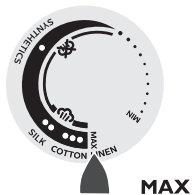

4 Seadke temperatuuri ketasregulaator MAX-asendisse.

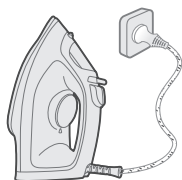

5 Ühendage seade maandatud seinakontakti.

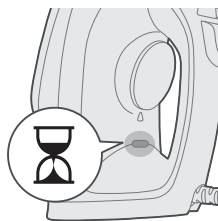

6 Märgutuli „triikraud valmis“ märgutuli süttib, mis näitab, et seade soojeneb.

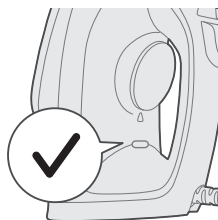

7 Oodake, kuni märgutuli „triikraud valmis“ kustub.

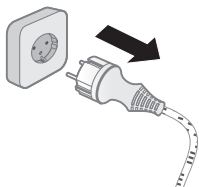

**8** Võtke triikraud pistikust välja.

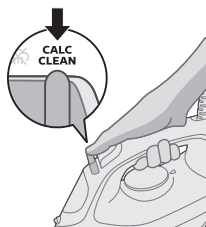

**9** Lükake aururegulaator katlakivi eemaldamise asendisse ja hoidke seal.



**10** Hoidke triikrauda kraanikausi kohal ja raputage õrnalt. Kuum vesi ja katlakiviosakesed eralduvad tallaplaadist.

Ettevaatust: Katlakivi minema uhtumisel väljub tallast ka aur ja keev vesi.

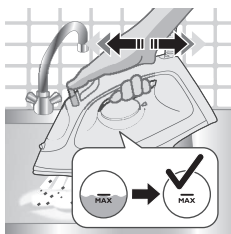

**11** Jätkake triikraua raputamist, kuni kogu veepaagis olev vesi on eraldunud.



**12** Ühendage triikraud vooluvõrku ja laske seadmel talla kuivatamiseks kuumeneda. See võtab aega umbes 2 minutit.

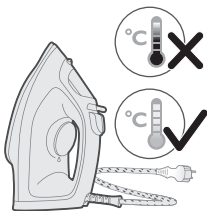

13 Laske seadmel jahtuda.

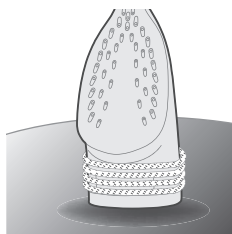

14 Kerige toitejuhe seadme kannu ümber.

## Hoiustamine

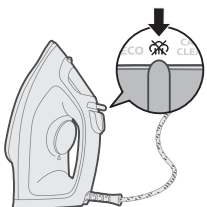

1 Libistage auruväljat, et valida aururežiim (kuiv triikimine) .

2 Eemaldage seadme pistik seinakontaktist.

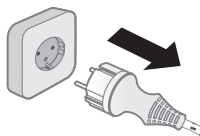

3 Laske seadmel jahtuda.

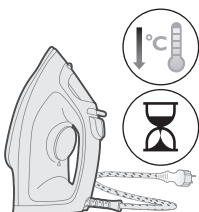

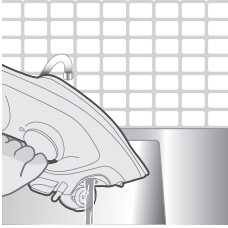

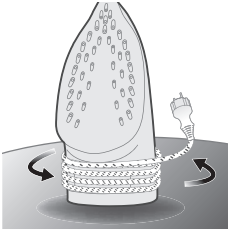

4 Valage veepaagis olev vesi välja.





5 Kerige toitejuhe ümber seadme põhikeha.

## Veaotsing

See peatükk annab ülevaate üldistest probleemidest, mis võivad selle seadmega seoses tekkida. Kui te ei suuda alljärgneva teabe abil ise probleemi lahendada, külastage veebilehte [www.philips.com/support](http://www.philips.com/support), kus on loetelu korduma kippuvatest küsimustest, või võtke ühendust oma riigi klienditeeninduskeskusega.

Probleem	Võimalik põhjus	Lahendus
Triikraud ei saa riietelt kortse eemaldada.	Triikimise ajal ei teki auru.	Täitke veepaak veega ja lükake aurulukk asendisse  .
Triikrauast ei tule mingitki auru.	Veepaagis ei ole piisavalt vett.	Täitke veepaak.
	Aururegulaator on seadistatud asendisse  .	Seadke auruliugur asendisse  .
	Triikraud ei ole auru tootmiseks piisavalt kuum.	Seadme kuumenemise ajal põleb märgutuli „triikraud valmis“ ühtlaselt. Seade on kasutamiseks valmis siis, kui tuli kustub.
Triikimise ajal langevad rõivaesemele veetilgad.	Olete kasutanud lisaauru funktsiooni lühikese aja jooksul liiga tihti.	Jätkake triikimist, hoides triikrauda horisontaalasendis ja oodake natuke aega, enne kui kasutate aurujoa funktsiooni uuesti.
	Te pole veepaagi kaant korralikult sulgenud.	Vajutage kaanele, kuni kostab klõpsatus.

Triikraud ei väljuta aurujuga.	Olete kasutanud lisaauru funktsiooni lühikese aja jooksul liiga tihti.	Jätkake triikimist, hoides triikrauda horisontaalasendis ja oodake natuke aega, enne kui kasutate aurujoa funktsiooni uuesti.
	Triikraud ei ole auru tootmiseks piisavalt kuum.	Oodake, kuni märgutuli „triikraud valmis“ on lõpetanud vilkumise ja jääb püsivalt põlema.
	Olete pannud mingit kemikaali veepaaki.	Loputage veepaak ja ärge lisage sinna lõhnaõli ega kemikaale.
Triikraua tallalt tilgub pärast selle vooluvõrgust lahtiühendamist või hoiustamist vett.	Aururegulaator on seadistatud asendisse  .	Seadke auruliugur asendisse  .
	Veepaaki on jäänud vett, kuid olete pannud triikraua horisontaalsesse asendisse.	Tühjendage veepaak pärast kasutamist või hoidke triikrauda vertikaalasendis.
Triikraud muudab riided läikivaks või jätab neile jälje.	Triigitav pind oli ebaühtlane, näiteks juhul kui triikisite õmbluse või voldi peal.	Triikrauda on kõikide triigitavate rõivaesemete triikimiseks ohutu kasutada. Lääge või jälg ei ole püsiv ning see läheb pesus välja. Ärge triikige õmblusi ega volte. Samuti võite jälgede vältimiseks asetada triigitavale pinnale puuvillase riide.

# Introducción

Le damos la enhorabuena por su adquisición y la bienvenida a Philips. Para poder beneficiarse por completo de la asistencia que ofrece Philips, registre el producto en [www.philips.com/welcome](http://www.philips.com/welcome). Lea con atención este manual de usuario, el folleto de información importante y la guía de inicio rápido antes de utilizar el aparato. Consérvelos por si necesitara consultarlos en el futuro.

## Descripción del producto

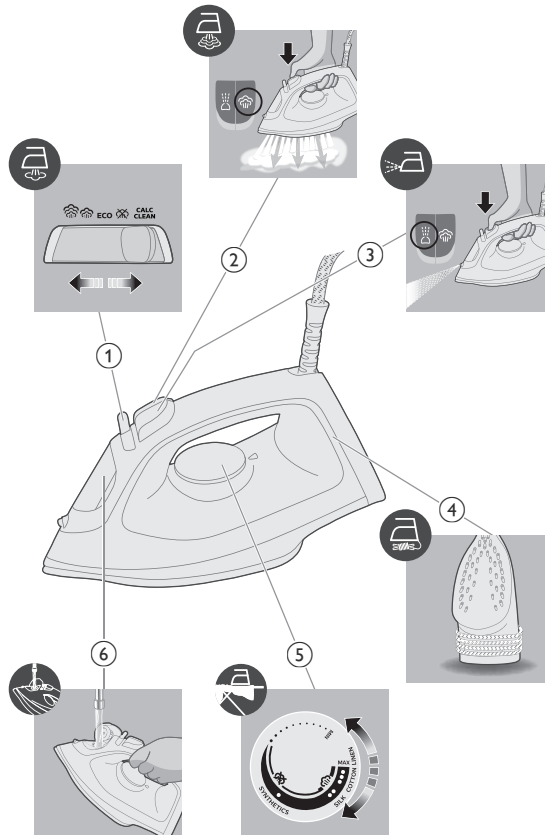

- 1 Selector de vapor
- 2 Botón Supervapor
- 3 Pulverización de agua
- 4 Recogecable
- 5 Control de temperatura
- 6 Tapa del depósito de agua

## Uso del aparato

### Preparación para su uso

Nota: Puede que salga un poco de humo de la plancha cuando la use por primera vez. Dejará de ocurrir al cabo de un rato.

#### Tipo de agua que puede utilizar

El aparato es adecuado para su uso con agua del grifo. Sin embargo, si vive en una zona con agua dura, le recomendamos que mezcle agua del grifo con agua destilada o desmineralizada a partes iguales. Esto evitará que se acumule cal rápidamente y prolongará la vida útil del aparato.

**No añadas perfume, agua de la secadora, vinagre, almidón, productos desincrustantes ni otros productos químicos, ya que pueden provocar fugas de agua, manchas marrones o daños en el aparato.**

### Llenado del depósito de agua

- 1 No enchufe el aparato.

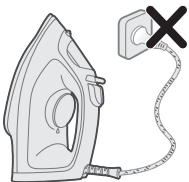

- 2 Asegúrese de que el aparato se haya enfriado.

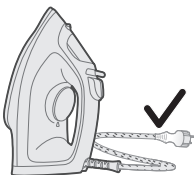

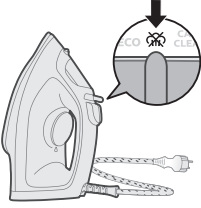

3 Deslice el selector de vapor hacia la derecha para seleccionar el modo de no vapor (planchado en seco) .

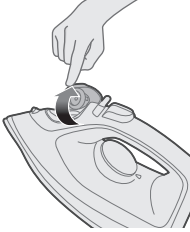

4 Gire para abrir la tapa del depósito.

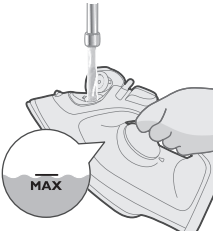

5 Llene el depósito de agua hasta la indicación MAX.



6 Cierre bien la tapa del depósito de agua.

## Ajuste de la temperatura



MAX  
LINO



● ● ●  
ALGODÓN





● ●  
SEDA

ECO

●  
SINTÉTICO

ECO



Posición ECO: Se suministra vapor constante mínimo de forma continuada para prendas con menos arrugas. Este ajuste también ahorra energía.



Dos nubes de vapor: Se suministra vapor más constante de forma continuada para prendas con arrugas más marcadas.



Tres nubes de vapor: Se suministra vapor constante de forma continuada para prendas con arrugas rebeldes.

## Uso del aparato

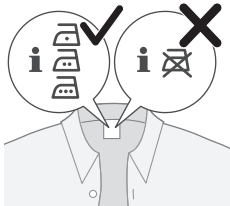

- 1 Compruebe el tipo de planchado en la etiqueta de la prenda.

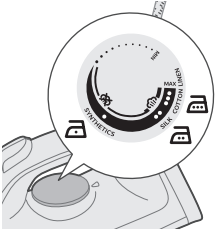

2 Ajuste el control de temperatura a la temperatura de planchado apropiada girándolo hasta la posición correcta.

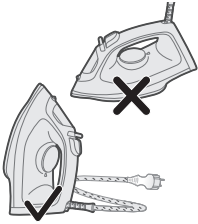

3 Deje descansar la plancha sobre su base.

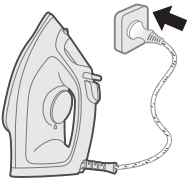

4 Conecte el aparato a un enchufe con toma de tierra.

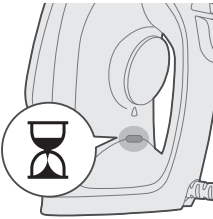

5 El piloto de plancha lista se iluminará para indicar que la plancha se está calentando.

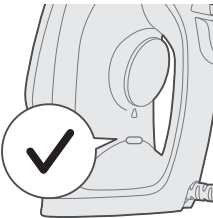

6 Cuando se apague el piloto de plancha lista, espere un poco antes de comenzar a planchar. Mientras esté planchando, el piloto de plancha lista se encenderá cada cierto tiempo.

## No vapor/Planchado en seco

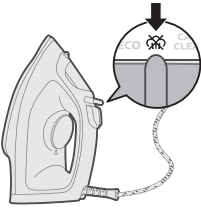

- 1 Ajuste la posición de vapor en una posición de no vapor.

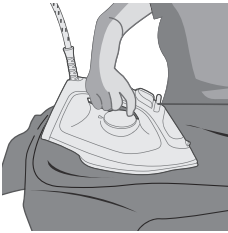

- 2 Después de un rato, dejará de salir vapor mientras se plancha.

## Pulverización de agua

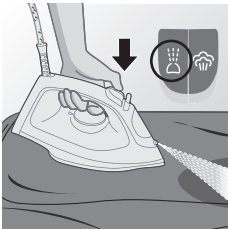

- 1 Ajuste la posición de vapor en una posición de no vapor. Pulse y suelte el botón de pulverización de agua para rociar una bruma y eliminar las arrugas rebeldes.

## Golpe de vapor

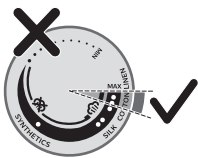

- 1 Ajuste el control de temperatura en la posición MAX entre algodón y lino.

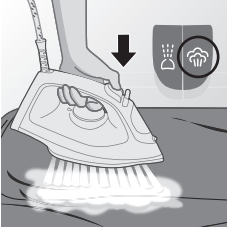

2 Pulse y suelte el botón de golpe de vapor para emitir un potente chorro de vapor y eliminar las arrugas rebeldes.

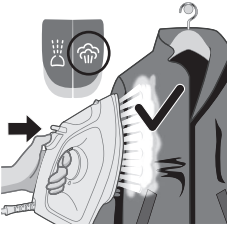

3 Puede utilizar la función de golpe de vapor con la plancha en posición vertical para eliminar las arrugas de prendas colgadas (solo para los modelos DST2020 y DST2030).

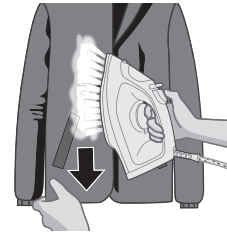

4 Tire y estire la prenda mientras aplica el golpe de vapor para eliminar las arrugas rebeldes (solo para los modelos DST2020 y DST2030).



5 No apoye el aparato en sus manos al planchar.



6 No apunte con el aparato hacia usted ni hacia otra persona.

## Modo de desconexión automática (DST2030)

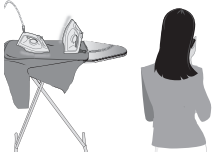

- 1 Para mayor tranquilidad, el aparato puede enfriarse por sí solo si se deja desatendido durante un período de tiempo.

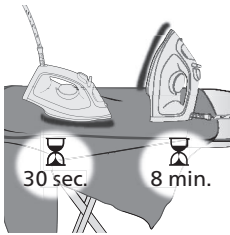

- 2 Si el aparato no se utiliza durante más de 30 segundos y está apoyado sobre la suela u 8 minutos apoyado sobre el talón o la base, entrará en el modo de desconexión automática.

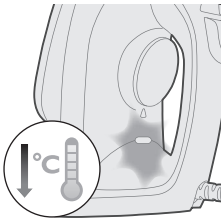

- 3 La temperatura del aparato disminuirá en el modo de desconexión automática. El piloto de plancha lista parpadea para indicar que el aparato se encuentra en estado de apagado automático. Para apagar completamente el artefacto, desenchúfelo de la pared.

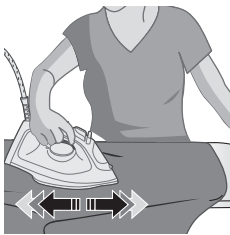

- 4 Para que la plancha vuelva a calentarse, levántela o muévala ligeramente.

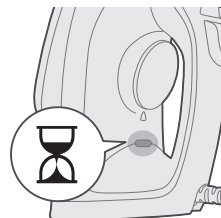

- 5 El piloto de plancha lista se iluminará para indicar que el aparato se está calentando.

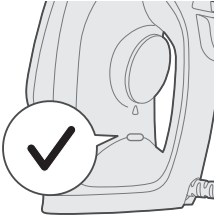

- 6 Una vez que el piloto de plancha lista se apague, el aparato estará listo para empezar a utilizarse.

## Limpieza y mantenimiento

- 1 Asegúrese de que el aparato no esté enchufado.

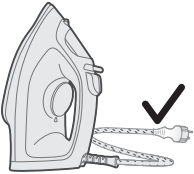
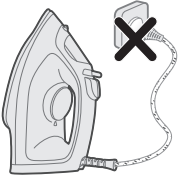

- 2 Asegúrese de que el aparato se haya enfriado.

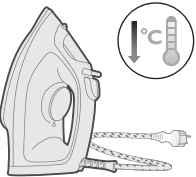

- 3 Limpie con un paño húmedo los restos de cal y otras impurezas que hayan podido quedar en la suela.





Nota: Con el fin de mantener la suela lisa, evite un contacto fuerte con objetos metálicos. No utilice nunca estropajos, vinagre ni productos químicos para limpiar la suela.

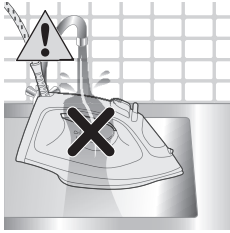

4 No lave el aparato bajo el grifo.

## Calc-Clean



Consejo: La función de liberación rápida de la cal se puede utilizar en cualquier momento. Si vive en una zona con agua dura, es recomendable que utilice la función más a menudo.

1 Después de 1 mes de uso, se recomienda usar la función Calc-Clean para eliminar la cal que se haya podido acumular en el aparato para prolongar su vida útil y asegurarse de que la plancha se calienta.

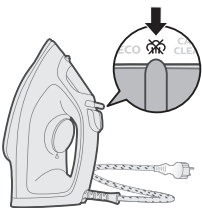

2 Asegúrese de que el aparato está desenchufado y el control de vapor en modo de no vapor (planchado en seco) .

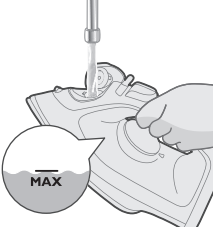

3 Llene el depósito de agua hasta la indicación MAX.



4 Ajuste el control de temperatura a la posición MAX.

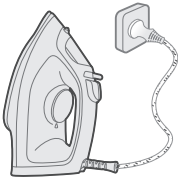

5 Conecte el aparato a un enchufe de pared con toma de tierra.

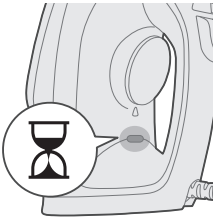

6 El piloto de plancha lista se iluminará para indicar que el aparato se está calentando.

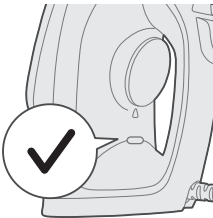

7 Espere a que el piloto de plancha lista se apague.



**8** Desenchufe la plancha

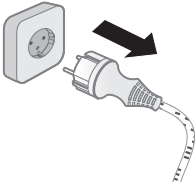

**9** Deslice el selector de vapor a la posición Calc-Clean y manténgalo pulsado.

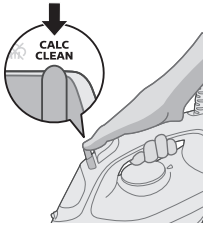

**10** Sujete la plancha sobre el fregadero y sacúdala con cuidado. La suela expulsará agua caliente y partículas de cal.

Precaución: Mientras se elimina la cal, también sale vapor y agua hirviendo por la suela.



**11** Continúe sacudiendo ligeramente la plancha hasta que se vacíe todo el depósito de agua.

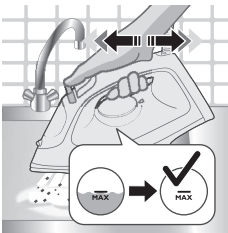

**12** Enchufe la plancha y deje que se caliente para secar la suela. Este proceso lleva unos 2 minutos.



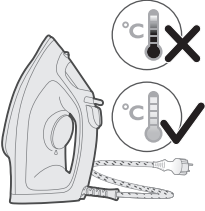

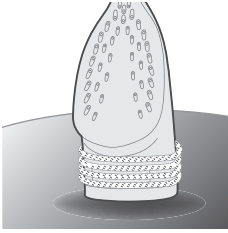

13 Deje enfriar la plancha.

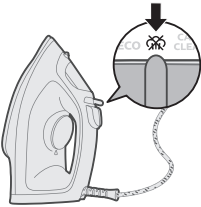

14 Enrolle el cable alrededor de la base de apoyo de la plancha.

## Almacenamiento



1 Deslice el selector de vapor para seleccionar el modo de no vapor (planchado en seco) .

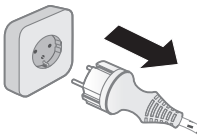

2 Desenchufe el aparato.

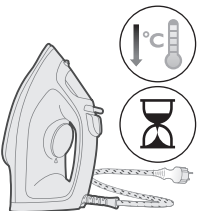

3 Deje que se enfríe el aparato.

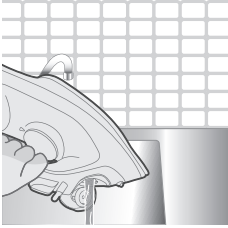

4 Vacíe el agua restante del depósito.

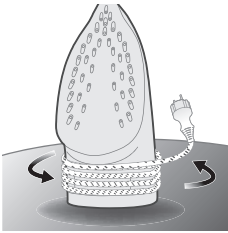



5 Enrolle el cable de alimentación alrededor de la base del aparato.

## Resolución de problemas

Este capítulo resume los problemas más comunes que podría encontrarse con el aparato. Si no puede resolver el problema con la siguiente información, visite [www.philips.com/support](http://www.philips.com/support) para consultar una lista de preguntas más frecuentes, o póngase en contacto con el servicio de atención al cliente en su país.

Problema	Posible causa	Solución
La plancha no elimina las arrugas de la prenda.	No se produce vapor durante el planchado.	Llene el depósito de agua y ajuste el control deslizante de vapor a la posición
La plancha no produce vapor.	No hay suficiente agua en el depósito.	Llene el depósito de agua.
	El control deslizante de vapor está ajustado a la posición	Ajuste el control deslizante de vapor a la posición
	La plancha aún no está lo suficientemente caliente como para producir vapor.	Mientras la plancha se está calentando, el piloto indicador de "plancha lista" permanece encendido. Cuando la plancha esté lista para su uso, el piloto se apagará.
Caen gotas de agua a la prenda durante el planchado.	Ha utilizado la función supervapor con demasiada frecuencia en un corto periodo de tiempo.	Continúe planchando en posición horizontal y espere unos minutos antes de volver a utilizar la función de golpe de vapor.

	No ha cerrado la tapa del depósito de agua correctamente.	Presione la tapa hasta que oiga un "clic".
La plancha no produce supervapor.	Ha utilizado la función supervapor con demasiada frecuencia en un corto periodo de tiempo.	Continúe planchando en posición horizontal y espere unos minutos antes de volver a utilizar la función de golpe de vapor.
	La plancha no está lo suficientemente caliente como para empezar a planchar.	Espere a que el piloto de "plancha lista" deje de parpadear y se ilumine de forma fija.
	Ha echado algún producto químico en el depósito de agua.	Enjuague el depósito de agua y no ponga perfume ni productos químicos en el mismo.
Salen gotas de agua de la suela después de desenchufar la plancha.	El control deslizante de vapor está ajustado a la posición  .	Ajuste el control deslizante de vapor a la posición  .
	Se ha colocado la plancha en posición horizontal cuando aún quedaba agua en el depósito.	Vacíe el depósito de agua después de cada uso o guarde la plancha en posición vertical.
La plancha deja brillo o una marca en la prenda.	La superficie que se desea planchar es desigual, por ejemplo, porque estaba planchando sobre una costura o un pliegue de la prenda.	La plancha se puede usar de forma segura con todas las prendas aptas para planchado. El brillo o la marca no son permanentes y desaparecerán al lavar la prenda. Evite planchar sobre costuras o pliegues, o bien coloque un paño de algodón sobre el área que desea planchar para evitar marcas.

# Introduction

Félicitations pour votre achat et bienvenue chez Philips ! Pour profiter pleinement de l'assistance offerte par Philips, enregistrez votre produit à l'adresse suivante : [www.philips.com/welcome](http://www.philips.com/welcome). Lisez attentivement ce mode d'emploi, la brochure « Informations importantes » et le guide de démarrage rapide avant d'utiliser l'appareil. Conservez-les pour une consultation ultérieure.

## Présentation du produit

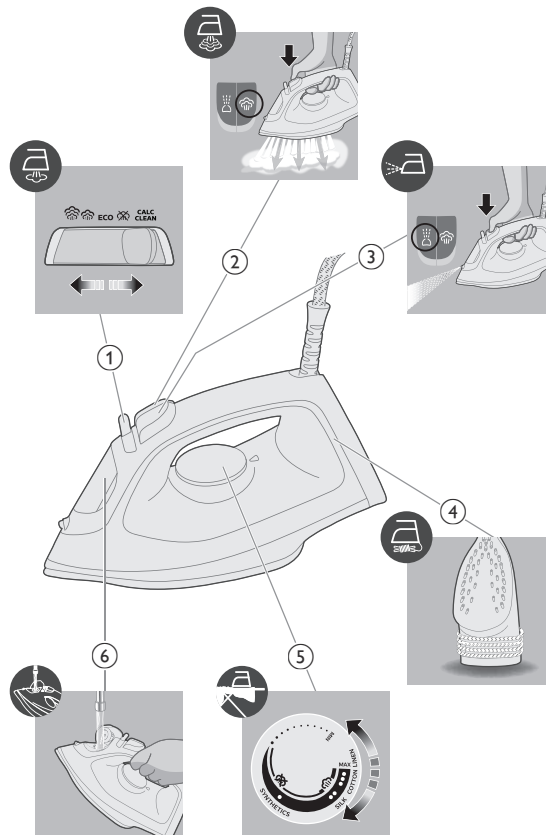

- 1 Sélecteur de vapeur
- 2 Bouton Effet pressing
- 3 Vaporisation d'eau
- 4 Enroulement du cordon
- 5 Thermostat
- 6 Couverture du réservoir d'eau

## Utilisation de l'appareil

### Avant utilisation

Remarque : Lors de la première utilisation, le fer à repasser peut dégager un peu de vapeur. Cela cesse après un bref instant.

#### Type d'eau à utiliser

Cet appareil accepte l'eau du robinet. Cependant, si vous vivez dans une région où l'eau est dure, nous vous recommandons de mélanger une quantité égale d'eau du robinet et d'eau distillée ou déminéralisée. Cela permettra d'éviter l'accumulation rapide de calcaire et prolongera la durée de vie de l'appareil.

**N'utilisez pas de parfum, d'eau provenant d'un sèche-linge, de vinaigre, d'amidon, de détartrants, de produits d'aide au repassage ou d'autres agents chimiques car ils peuvent entraîner des projections d'eau, des taches marron ou endommager votre appareil.**

### Remplissage du réservoir

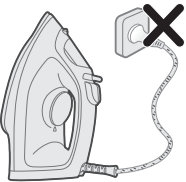

- 1 Ne branchez pas l'appareil.

2 Assurez-vous que l'appareil a refroidi.

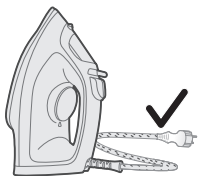

3 Faites glisser le sélecteur de vapeur vers la droite pour sélectionner le mode sans vapeur (repassage à sec) ~~☒~~.

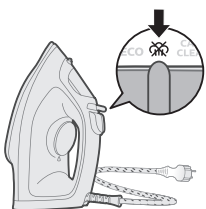

4 Ouvrez le couvercle du réservoir d'eau.

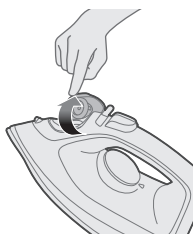

5 Remplissez le réservoir d'eau jusqu'au niveau MAX.

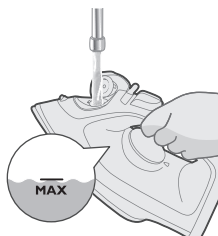

6 Fermez correctement le couvercle du réservoir d'eau.

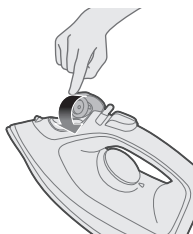

## Réglage de la température



	MAX LIN	
	● ● ● COTON	
	● ● SOIE	<b>ECO</b>
	● SYNTHÉTIQUE	



Réglage ECO : production d'une vapeur constante minimale pour les tissus peu froissés. Ce réglage permet également d'économiser de l'énergie.



Deux nuages de vapeur : production d'une vapeur constante plus importante pour éliminer les faux plis tenaces.



Trois nuages de vapeur : production d'une vapeur constante maximale pour éliminer les faux plis les plus tenaces.



## Utilisation de l'appareil

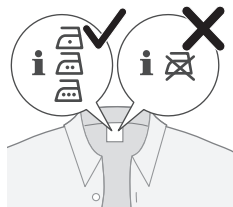

- 1 Consultez l'étiquette du vêtement pour connaître les recommandations de repassage.

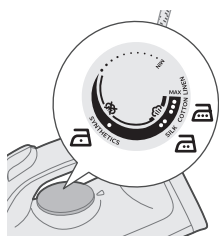

- 2 Réglez le thermostat sur la position adéquate en le tournant vers l'indication de température de votre choix.

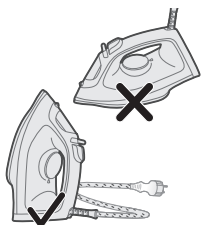

- 3 Posez le fer à repasser sur son talon.

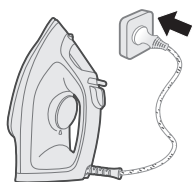

- 4 Branchez l'appareil sur une prise secteur avec mise à la terre.

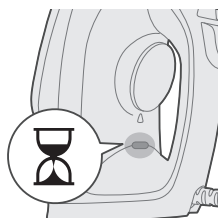

- 5 Le témoin « Fer prêt » s'allume pour indiquer que le fer à repasser chauffe.

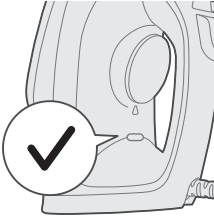

- 6 Une fois le témoin « Fer prêt » éteint, patientez un court instant avant de commencer à repasser. Le témoin « Fer prêt » s'allume de temps en temps pendant le repassage.

## Sans vapeur/repassage à sec

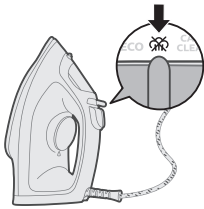

- 1 Sélectionnez le réglage Sans vapeur.

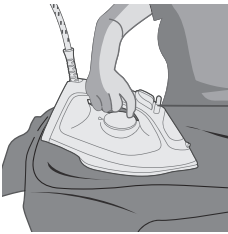

- 2 Après un court instant, la vapeur s'arrête pendant le repassage.

## Vaporisation d'eau

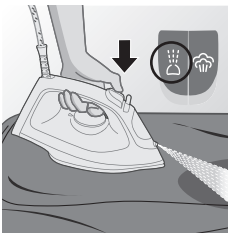

- 1 Sélectionnez le réglage Sans vapeur. Appuyez brièvement sur le bouton de pulvérisation d'eau pour obtenir un jet de fines gouttelettes et éliminer les plis tenaces.

## Effet pressing

- 1 Réglez le thermostat sur la position MAX, entre coton et lin.

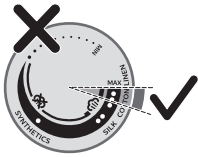

- 2 Appuyez sur le bouton Effet pressing, puis relâchez-le pour un jet de vapeur puissant afin d'éliminer les faux plis les plus tenaces.



- 3 Vous pouvez également utiliser la fonction Effet pressing lorsque vous tenez le fer en position verticale pour éliminer les faux plis des vêtements sur cintre (pour les modèles DST2020 et DST2030 uniquement).

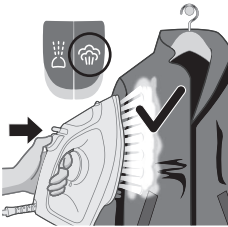

- 4 Tirez sur votre vêtement en utilisant la fonction Effet pressing pour éliminer les faux plis tenaces (pour les modèles DST2020 et DST2030 uniquement).

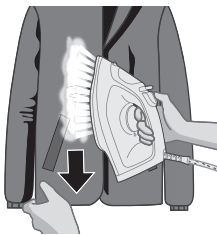

- 5 N'utilisez pas votre main nue comme surface de support lorsque vous repassez un vêtement.



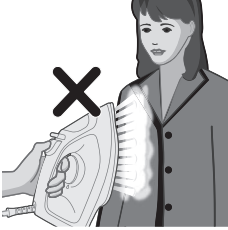

6 N'orientez pas l'appareil vers vous ou une autre personne.

## Arrêt automatique (DST2030)



1 Pour une plus grande tranquillité d'esprit, l'appareil refroidira de lui-même s'il est laissé sans surveillance pendant un certain temps.

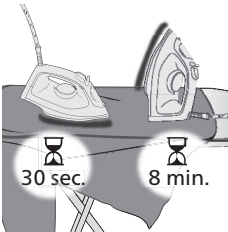
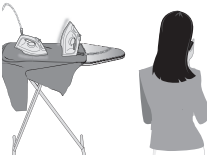

2 Si l'appareil est inutilisé pendant plus de 30 secondes lorsqu'il est posé sur la semelle, ou 8 minutes lorsqu'il est posé sur le talon ou la base, il passe en mode d'arrêt automatique.

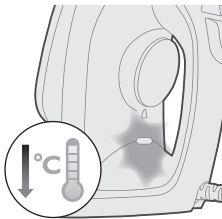

3 La température de l'appareil diminue en mode d'arrêt automatique. Le témoin « Fer prêt » clignote continuellement pour indiquer que l'appareil est en mode d'arrêt automatique. Pour éteindre complètement l'appareil, débranchez-le de la prise.

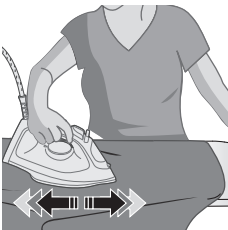

4 Pour que l'appareil chauffe à nouveau, prenez-le en main ou déplacez-le légèrement.

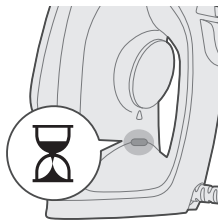

5 Le témoin « Fer prêt » s'allume pour indiquer que l'appareil chauffe.

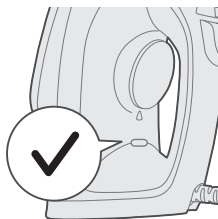

6 Une fois le témoin « Fer prêt » éteint, l'appareil est prêt à l'emploi.

## Nettoyage et entretien

1 Assurez-vous que l'appareil n'est pas branché.

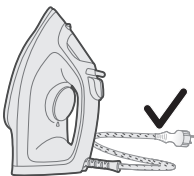
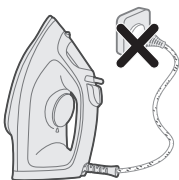

2 Assurez-vous que l'appareil a refroidi.

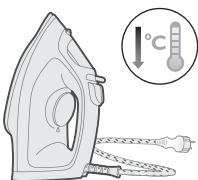

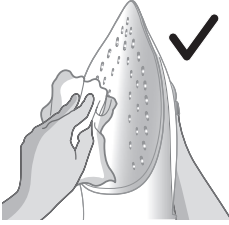

3 Essuyez les particules et autres dépôts de la semelle avec un chiffon humide.



Remarque : Évitez le contact de la semelle avec tout objet métallique afin de ne pas l'endommager. N'utilisez jamais de tampons à récurer, vinaigre ou autres produits chimiques pour nettoyer la semelle.



4 Ne nettoyez pas l'appareil sous l'eau du robinet.

## Fonction Calc-Clean

Conseil : La fonction Quick Calc Release peut être utilisée à tout moment. Si vous habitez dans une région où l'eau est calcaire, utilisez cette fonction plus fréquemment.



1 Après 1 mois d'utilisation, il est recommandé d'effectuer un détartrage pour éliminer les dépôts de calcaire accumulés sur votre appareil afin de prolonger sa durée de vie et de s'assurer qu'il chauffe.

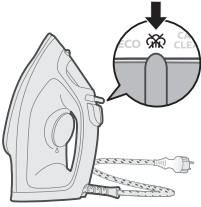

- 2 Assurez-vous que le fer à repasser est débranché et que le réglage de vapeur sélectionné est Sans vapeur (repassage à sec) .

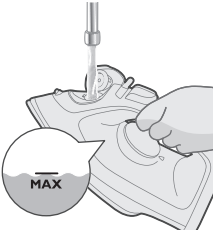

- 3 Remplissez le réservoir d'eau jusqu'à l'indication MAX.



- 4 Réglez le thermostat sur la position MAX.

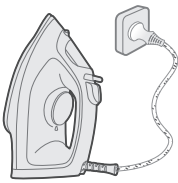

- 5 Branchez l'appareil sur une prise secteur avec mise à la terre.

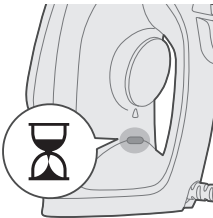

- 6 Le témoin « Fer prêt » s'allume pour indiquer que l'appareil chauffe.

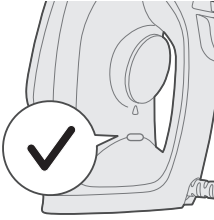

7 Attendez que le témoin « Fer prêt » s'éteigne.

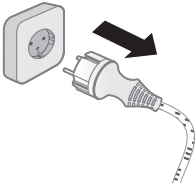

8 Débranchez le fer à repasser.

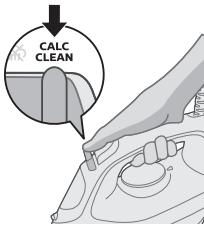

9 Maintenez le sélecteur de vapeur en position Calc-Clean.



10 Tenez le fer à repasser au-dessus de l'évier et secouez-le doucement. De l'eau chaude et des particules de calcaire s'échappent de la semelle.

Attention : Lorsque les résidus de calcaire sont évacués, de la vapeur et de l'eau bouillante sortent également de la semelle.

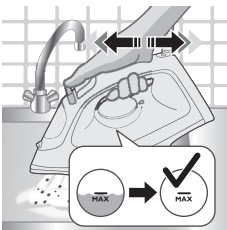

11 Continuez à secouer le fer à repasser jusqu'à ce que le réservoir d'eau soit vide.





**12** Branchez l'appareil et laissez-le chauffer pour sécher la semelle. L'opération prend environ 2 minutes.

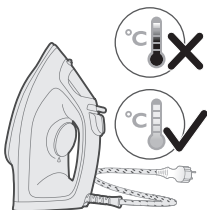

**13** Laissez le fer refroidir.

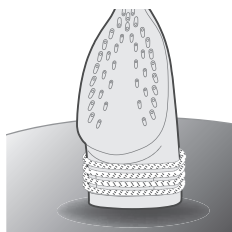

**14** Enroulez le cordon autour du talon du fer.

## Rangement

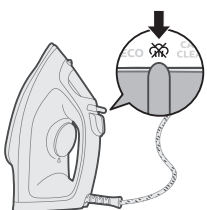

**1** Faites glisser le sélecteur de vapeur sur le mode Sans vapeur (repassage à sec) ~~OFF~~.

**2** Débranchez l'appareil.

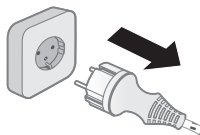

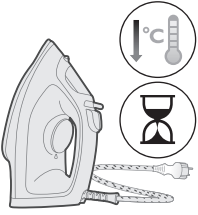

3 Laissez refroidir l'appareil.

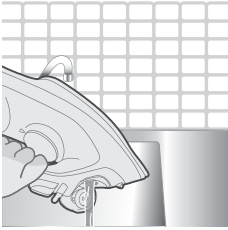

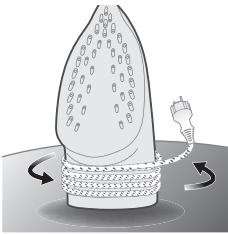

4 Videz l'eau restant dans le réservoir.





5 Enroulez le cordon autour du corps de l'appareil.

## Dépannage

Cette rubrique présente les problèmes les plus courants que vous pouvez rencontrer avec votre appareil. Si vous ne parvenez pas à résoudre le problème à l'aide des informations ci-dessous, rendez-vous sur [www.philips.com/support](http://www.philips.com/support) pour consulter les questions fréquemment posées ou contactez le Service Consommateurs de votre pays.

Problème	Cause possible	Solution
Le fer ne permet pas d'enlever les plis du vêtement.	Il n'y a pas de vapeur lors du repassage.	Remplissez le réservoir d'eau et réglez le curseur de vapeur sur  .
L'appareil ne produit pas de vapeur.	Il n'y a pas assez d'eau dans le réservoir.	Remplissez le réservoir d'eau.
	Le curseur de vapeur est réglé sur  .	Réglez le curseur de vapeur sur  .

	Le fer n'est pas encore suffisamment chaud pour produire de la vapeur.	Lorsque le fer chauffe, le témoin « Fer prêt » est allumé en continu. Lorsque le témoin s'éteint, le fer est prêt à l'emploi.
Des gouttes d'eau tombent sur le vêtement lors du repassage.	La fonction Effet pressing a été utilisée trop fréquemment sur un laps de temps trop court.	Continuez à utiliser le fer en position horizontale et patientez quelques instants avant d'utiliser de nouveau la fonction Effet pressing.
	Vous n'avez pas fermé le couvercle du réservoir d'eau correctement.	Appuyez sur le couvercle jusqu'à ce que vous entendiez un clic.
La fonction Effet pressing du fer ne fonctionne pas.	La fonction Effet pressing a été utilisée trop fréquemment sur un laps de temps trop court.	Continuez à utiliser le fer en position horizontale et patientez quelques instants avant d'utiliser de nouveau la fonction Effet pressing.
	Le fer n'est pas encore suffisamment chaud pour le repassage.	Patiencez jusqu'à ce que le voyant « Fer prêt » cesse de clignoter et s'allume de manière continue.
	Vous avez ajouté un produit chimique dans le réservoir d'eau.	Rincez le réservoir d'eau et n'y ajoutez aucun parfum ni produit chimique.
De l'eau s'écoule de la semelle après que le fer a été débranché.	Le curseur de vapeur est réglé sur  .	Réglez le curseur de vapeur sur  .
	Vous avez peut-être rangé le fer en position horizontale alors que le réservoir n'était pas vide.	Videz le réservoir d'eau après utilisation ou rangez le fer en position verticale.
Le fer lustre ou marque le vêtement.	La surface de repassage n'était pas plane, par exemple parce que vous avez repassé sur une couture ou un pli du vêtement.	Le fer à repasser peut être utilisé en toute sécurité sur tous les vêtements repassables. Les marques ou traces lustrées ne sont pas permanentes et disparaissent au lavage. Évitez de repasser sur les coutures ou les plis. Vous pouvez également placer un tissu en coton sur la zone à repasser pour éviter les marques.

## Uvod

Čestitamo Vam na kupnji i dobro došli u Philips! Kako biste potpuno iskoristili podršku koju nudi Philips, registrirajte svoj proizvod na [www.philips.com/welcome](http://www.philips.com/welcome). Prije uporabe aparata pažljivo pročitajte ovaj korisnički priručnik, letak s važnim informacijama i kratke upute. Spremite ih za buduće potrebe.

## Pregled proizvoda

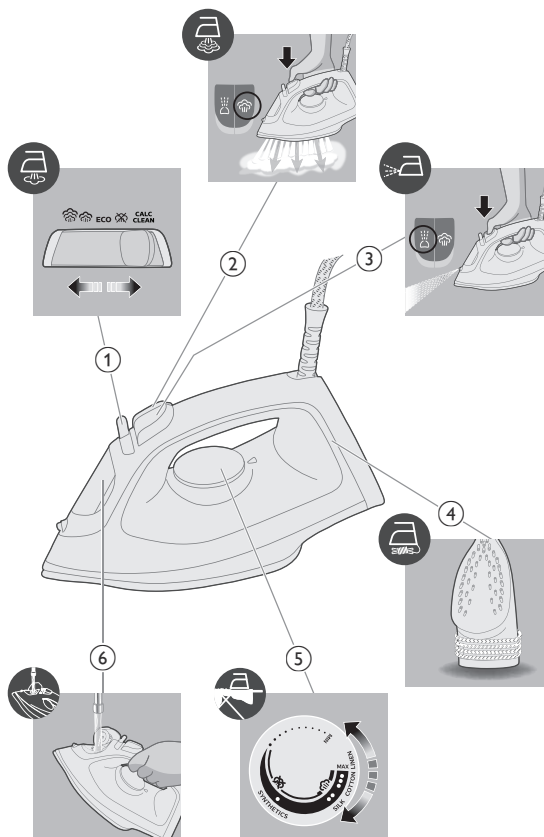

- 1 Gumb za odabir pare
- 2 Gumb za dodatnu količinu pare
- 3 Raspršivanje vode
- 4 Namotavanje kabela
- 5 Regulator temperature
- 6 Poklopac spremnika za vodu

## Uporaba aparata

### Priprema za uporabu

Napomena: Prilikom prve uporabe glačala možda ćete primijetiti malo pare. To će ubrzo prestati.

#### **Vrsta vode koju treba upotrebljavati**

Aparat je prikladan za uporabu s vodom iz slavine. Međutim, ako živite u području s vrlo tvrdom vodom, preporučujemo da miješate jednaku količinu destilirane ili demineralizirane vode s vodom iz slavine. Time ćete spriječiti brzo nakupljanje kamenca te produžiti životni vijek svog aparata.

**Nemojte dodavati parfem, vodu iz sušilice, ocat, izbjeljivač, sredstva protiv kamenca, sredstva za olakšavanje glačanja, vodu koja je kemijski očišćena od kamenca ili druge kemikalije jer mogu uzrokovati naglo izbacivanje vode, smeđe mrlje ili oštećenje aparata.**

### Punjenje spremnika za vodu

- 1 Nemojte ukopčavati aparat.

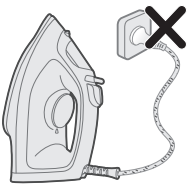

2 Provjerite je li se aparat ohladio.

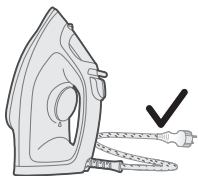

3 Povucite gumb za odabir pare u desnu stranu kako biste odabrali način rada bez pare (suho glačanje) ~~☁~~.

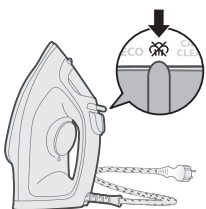

4 Otvorite poklopac spremnika za vodu.

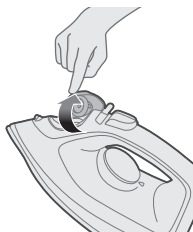

5 Napunite spremnik za vodu do oznake MAX u spremniku za vodu.

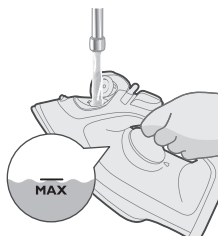

6 Čvrsto zatvorite poklopac spremnika za vodu.

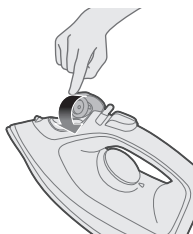

## Postavljanje temperature



	MAX LAN	
	● ● ● PAMUK	
	● ● SVILA	<b>ECO</b>
	● SINTETIKA	

ECO



Ekološka postavka: Minimalna dosljedna količina pare kontinuirano se ispušta kako bi odjevni predmeti imali manje nabora. Osim toga, ova postavka štedi energiju.



Dva oblaka pare: Veća dosljedna količina pare kontinuirano se ispušta radi uklanjanja tvrdokornih nabora.



Tri oblaka pare: Najveća moguća dosljedna količina pare kontinuirano se ispušta radi uklanjanja tvrdokornih nabora.

## Uporaba aparata

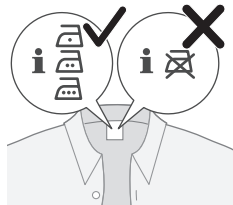

1 Dozvoljenu temperaturu glačanja pronadite na ušivenoj markici.

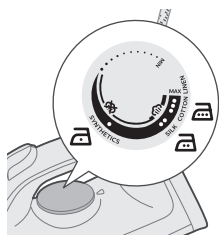

2 Postavite regulator temperature na potrebnu temperaturu glačanja okretanjem do oznake odgovarajuće temperature.

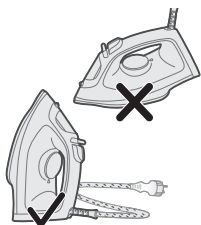

3 Glačalo postavite u uspravan položaj.

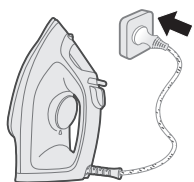

4 Aparat ukopčavajte u uzemljenu zidnu utičnicu.

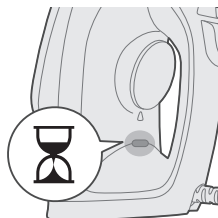

5 Indikator spremnosti za glačanje počeo će svijetliti, naznačujući da se glačalo zagrijava.



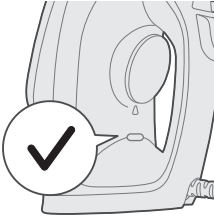

- 6 Kad se indikator spremnosti za glačanje isključi, pričekajte neko vrijeme prije nego što počnete glačati. Indikator spremnosti za glačanje će se tijekom glačanja povremeno uključivati i isključivati.

## Bez pare / suho glačanje

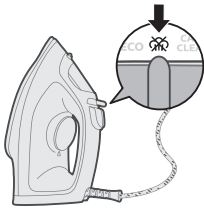

- 1 Postavite postavku pare na glačanje bez pare.

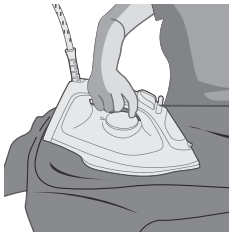

- 2 Nakon kraćeg vremena, para će se prestati ispuštati tijekom glačanja.

## Raspršivanje vode



- 1 Postavite postavku pare na glačanje bez pare. Pritisnite i otpustite gumb za raspršivanje vode za raspršivanje izmaglice koja osigurava uklanjanje tvrdokornih nabora.

## Dodatna količina pare

- 1 Postavite regulator temperature na postavku MAX, između pamuka i lana.

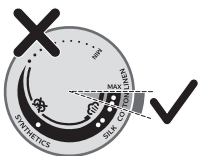

- 2 Pritisnite i otpustite gumb za dodatnu količinu pare koja će ukloniti tvrdokorne nabore.



- 3 Funkcija dodatne količine pare može se upotrebljavati i kad je glačalo u okomitom položaju za uklanjanje nabora na izvješenoj odjeći (samo za DST2020 i DST2030).



- 4 Povucite i razvucite odjevni predmet dok primjenjujete dodatnu količinu pare za uklanjanje tvrdokornih nabora na odjeći (samo za DST2020 i DST2030).

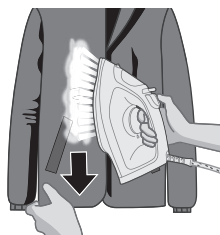

- 5 Nemojte golom šakom podržavati odjevni predmet prilikom glačanja.



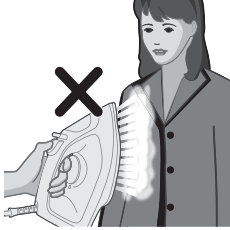

- 6 Nemojte aparat držati uperen prema sebi / drugoj osobi.

## Način rada automatskog isključivanja (DST2030)

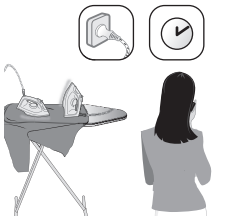

- 1 Kako biste bili mirniji, aparat će se samostalno ohladiti ako ga određeno vrijeme ostavite bez nadzora.

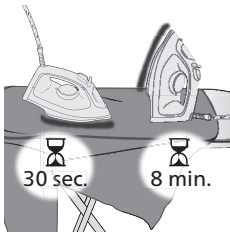

- 2 Ako se aparat ne upotrebljava duže od 30 sekundi dok je postavljen na stopalu za glačanje ili dok je 8 minuta postavljen na svoj donji dio/podnožje, aktivirat će se način rada automatskog isključivanja.

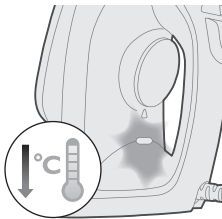

- 3 Temperatura aparata smanjit će se u načinu rada automatskog isključivanja. Indikator spremnosti za glačanje neće prestati bljeskati, naznačujući tako da je aparat u statusu automatskog isključivanja. Kako biste potpuno isključili aparat, iskopčajte ga iz utičnice.

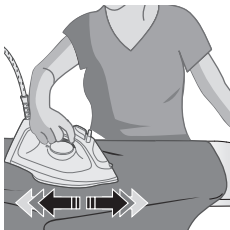

- 4 Kako bi se aparat ponovo zagrijao, podignite ga ili lagano pomaknite.

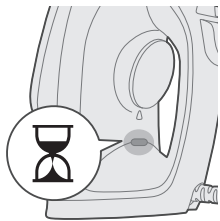

5 Indikator spremnosti za glačanje počet će svijetliti, naznačujući da se aparat zagrijava.

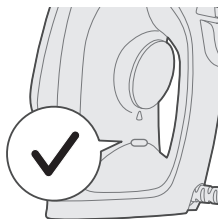

6 Kada se indikator spremnosti za glačanje isključi, aparat je spreman za uporabu.

## Čišćenje i održavanje

1 Provjerite da aparat nije ukopčan u napajanje.

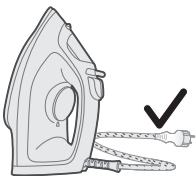
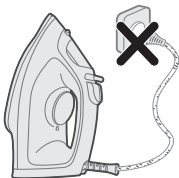

2 Provjerite je li se aparat ohladio.

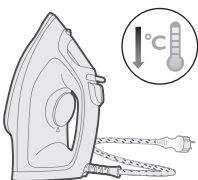

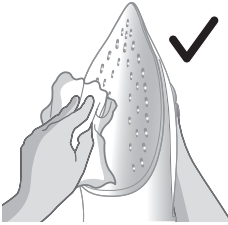

- 3 Očistite komadiće kamena i ostalu nečistoću s površine za glačanje vlažnom krpom.

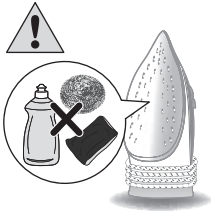

Napomena: Stopalo za glačanje uvijek treba biti glatko pa izbjegavajte kontakt s metalnim predmetima. Za čišćenje stopala za glačanje nikada nemojte upotrebljavati spužvicu za ribanje, ocat i druge kemikalije.

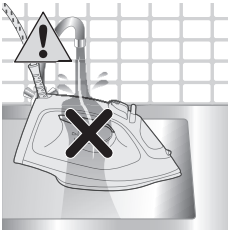

- 4 Aparat nemojte prati/čistiti pod mlazom vode iz slavine.

## Calc-Clean

Savjet: Funkciju brzog čišćenja kamena možete upotrebljavati u bilo kojem trenutku. Ako stanujete u području s tvrdom vodom, češće upotrebljavajte funkciju.



- 1 Nakon mjesec dana uporabe aparata preporučuje se uklanjanje kamena koji se nakupio na njemu kako bi se produžio njegov vijek trajanja i kako bi se osiguralo njegovo zagrijavanje.

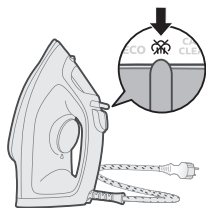

2 Provjerite je li aparat iskopčan i je li postavka pare postavljena na način rada bez pare (suho glačanje) .

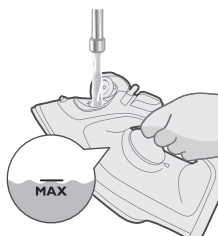

3 Napunite spremnik za vodu do oznake MAX.

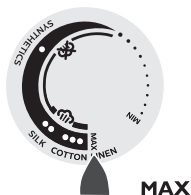

4 Postavite regulator temperature na MAX.

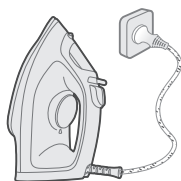

5 Aparat ukopčajte u uzemljenu zidnu utičnicu.

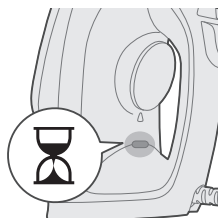

6 Indikator spremnosti za glačanje počet će svijetliti, naznačujući da se aparat zagrijava.

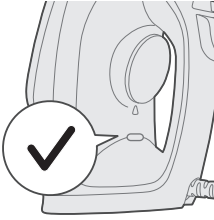

7 Pričekajte da indikator spremnosti za glačanje prestane svijetliti.

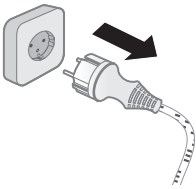

8 Iskopčajte glačalo iz utičnice.

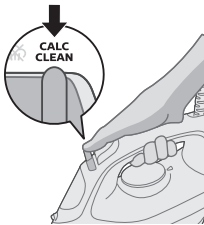

9 Pomaknite gumb za odabir pare na položaj Calc-Clean i zadržite.



10 Držite glačalo iznad sudopera i nježno ga protresite. Iz stopala za glačanje izaći će vruća voda i komadići kamenca.

Oprez: Prilikom ispiranja kamenca iz stopala za glačanje izlaze i para i ključala voda.

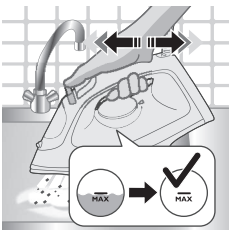

11 Nastavite tresti glačalo dok ne iscure sva voda iz spremnika.

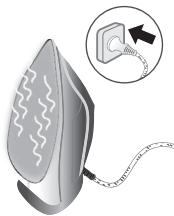

**12** Ukopčajte aparat i ostavite ga da se zagrije kako bi se stopalo za glačanje osušilo. To će potrajati otprilike 2 minute.

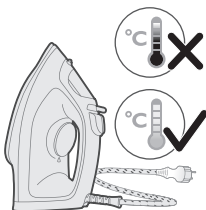

**13** Pustite glačalo da se ohladi.

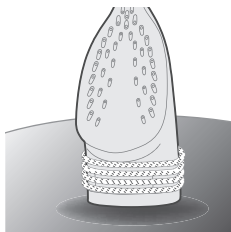

**14** Kabel namotajte oko donjeg dijela glačala.

## Pohrana

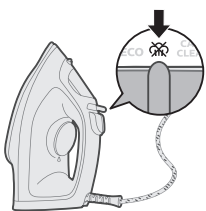

**1** Pomaknite gumb za odabir pare kako biste odabrali način rada bez pare (suho glačanje) ~~OFF~~.

**2** Iskopčajte aparat.

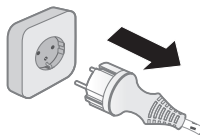



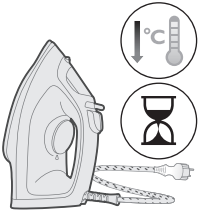

3 Pustite da se aparat ohladi.

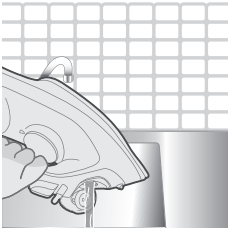

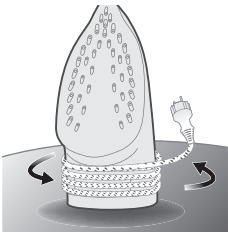

4 Ispraznite ostatak vode iz spremnika za vodu.



5 Kabel za napajanje namotajte oko glavnog dijela aparata.

## Rješavanje problema

U ovom poglavlju opisani su uobičajeni problemi vezani uz uporabu aparata. Ako problem ne možete riješiti s pomoću informacija u nastavku, posjetite [www.philips.com/support](http://www.philips.com/support) kako biste pronašli popis čestih pitanja ili se obratite centru za korisničku podršku u svojoj državi.

Problem	Mogući uzrok	Rješenje
Glačalo ne može ukloniti nabore s odjevnog predmeta.	Nema pare tijekom glačanja.	Napunite spremnik za vodu i postavite klizni gumb za paru na  .
Glačalo ne proizvodi paru.	U spremniku nema dovoljno vode.	Napunite spremnik za vodu.
	Klizni gumb za paru postavljen je u položaj  .	Postavite klizni gumb za paru na  .

	Glačalo još nije dovoljno vruće za proizvodnju pare.	Dok se glačalo zagrijava, indikator spremnosti za glačanje postojano svijetli. Kada glačalo bude spremno za uporabu, indikator će se isključiti.
Tijekom glačanja na odjevni predmet kapa voda.	Prečesto ste upotrijebili funkciju za dodatnu količinu pare u kratkom razdoblju.	Nastavite glačati u vodoravnom položaju i pričekajte malo prije ponovne uporabe funkcije dodatne količine pare.
	Niste dobro zatvorili poklopac spremnika za vodu.	Pritišćite poklopac dok ne čujete „klik“.
Glačalo ne proizvodi dodatnu količinu pare.	Prečesto ste upotrijebili funkciju dodatne količine pare u kratkom razdoblju.	Nastavite glačati u vodoravnom položaju i pričekajte malo prije ponovne uporabe funkcije dodatne količine pare.
	Glačalo još nije dovoljno vruće za glačanje.	Pričekajte da indikator spremnosti za glačanje prestane bljeskati i počne stalno svijetliti.
	Stavili ste kemikaliju u spremnik za vodu.	Isperite spremnik za vodu i u njega nemojte stavljati parfem niti kemikalije.
Voda kapa iz stopala za glačanje nakon što se glačalo iskopča.	Klizni gumb za paru postavljen je u položaj  .	Postavite klizni gumb za paru na  .
	Stavili ste glačalo u vodoravan položaj s preostalom vodom u spremniku.	Spremnik za vodu ispraznite nakon uporabe ili spremite glačalo u okomitom položaju.
Glačalo na odjevnim predmetima ostavlja odsjaj ili otiske.	Površina koju je trebalo izglačati bila je neravna, primjerice zbog glačanja preko šavova ili pregiba.	Glačalo se može sigurno upotrebljavati na svim odjevnim predmetima koji se mogu glačati. Odsjaj ili otisak nije trajan i nestat će kada operete odjevni predmet. Izbjegavajte glačanje preko šavova ili pregiba. Možete i preko područja za glačanje staviti pamučnu krpu kako bi se izbjeglo stvaranje otisaka.

# Introduzione

Congratulazioni per l'acquisto. Ti diamo il benvenuto in Philips! Per trarre il massimo vantaggio dall'assistenza fornita da Philips, registrare il proprio prodotto sul sito: [www.philips.com/welcome](http://www.philips.com/welcome). Leggere attentamente il presente manuale utente, l'importante brochure informativa e la guida rapida prima di utilizzare l'apparecchio e conservarli per riferimenti futuri.

## Panoramica del prodotto

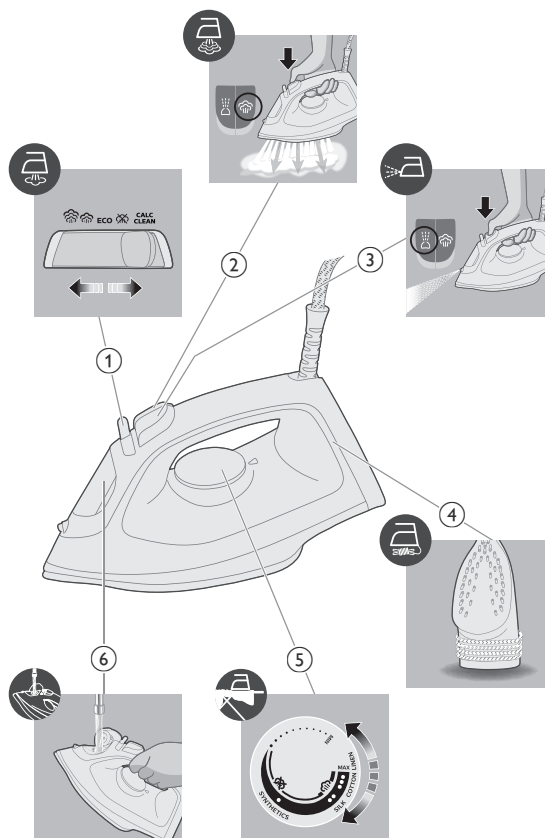

- 1 Selettore del vapore
- 2 Pulsante colpo di vapore
- 3 Nebulizzatore
- 4 Avvolgicavo
- 5 Termostato
- 6 Coperchio del serbatoio dell'acqua

## Utilizzo dell'apparecchio

### Preparazione per l'uso

Nota: al primo utilizzo, il ferro potrebbe emettere del vapore. Tale fenomeno è destinato a scomparire in breve tempo.

#### Tipo di acqua da utilizzare

È possibile usare l'apparecchio con l'acqua del rubinetto. Tuttavia, se si vive in aree caratterizzate dalla presenza di acqua dura, si consiglia di mescolare l'acqua del rubinetto con la stessa quantità di acqua distillata o demineralizzata. Ciò consentirà di evitare la rapida formazione di calcare e di prolungare la vita dell'apparecchio.

**Non aggiungere profumo, acqua proveniente dall'asciugatrice, aceto, amido, agenti decalcificanti, prodotti per la stiratura, acqua decalcificata chimicamente o altre sostanze chimiche, poiché potrebbero causare la fuoriuscita di acqua, la comparsa di macchie marroncine oppure danni all'apparecchio.**

### Riempimento del serbatoio dell'acqua

- 1 Non collegare l'apparecchio alla presa di corrente.

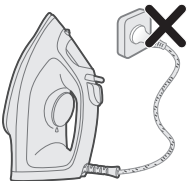

- 2 Assicurarsi che l'apparecchio si sia raffreddato.

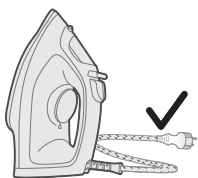

- 3 Spostare il selettore del vapore verso destra per selezionare la modalità senza vapore (stiratura a secco) ~~☒~~.

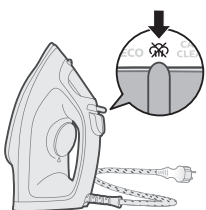

- 4 Aprire il coperchio del serbatoio dell'acqua.

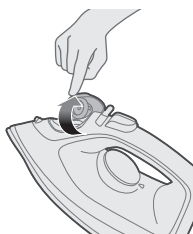

- 5 Riempire il serbatoio dell'acqua fino al livello massimo (MAX).

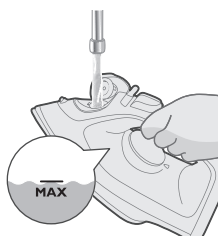

- 6 Chiudere saldamente il coperchio del serbatoio dell'acqua.

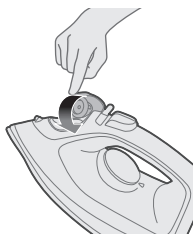

# Impostazione della temperatura



	MAX LINO	
	● ● ● COTONE	
	● ● SETA	<b>ECO</b>
	● TESSUTI SINTETICI	



Impostazione ECO: viene erogato vapore costante all'intensità minima per gli indumenti con un minor numero di pieghe. Questa impostazione consente anche di risparmiare energia.



Vapore forte (due nuvole): viene erogato vapore costante all'intensità massima per eliminare le pieghe più ostinate.



Vapore intenso (tre nuvole): viene erogato maggiore vapore costante all'intensità massima per eliminare le pieghe più ostinate.

## Utilizzo dell'apparecchio

- 1 Controllare sull'etichetta dell'indumento la stiratura più appropriata.

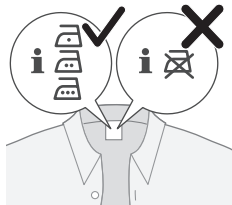

- 2 Impostare il termostato ruotandolo sull'indicazione della temperatura adeguata.

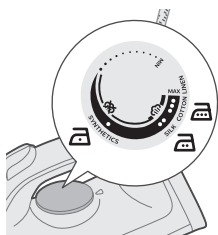

- 3 Lasciare riposare il ferro in posizione verticale.

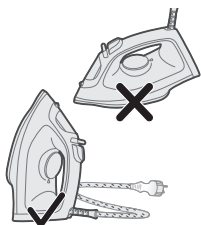

- 4 Collegare l'apparecchio a una presa a muro con messa a terra.

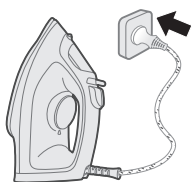

- 5 La spia "ferro pronto" si accende, a indicare che il ferro si sta riscaldando.

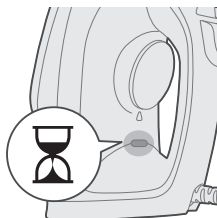

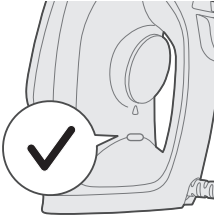

- 6 Quando la spia "ferro pronto" si spegne, attendere qualche minuto prima di iniziare a stirare. La spia si accende di tanto in tanto durante la stiratura.

## Modalità senza vapore/stiratura a secco

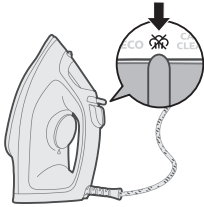

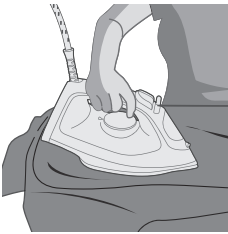

- 1 Impostare la modalità senza vapore.

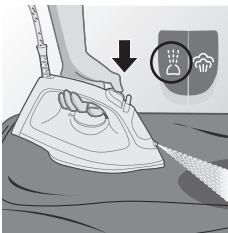

- 2 Il vapore cesserà in breve tempo durante la stiratura.

## Nebulizzatore



- 1 Impostare la modalità senza vapore. Premere e rilasciare il pulsante nebulizzatore  per ottenere un getto d'acqua nebulizzata, ideale per rimuovere le pieghe più ostinate.



## Colpo di vapore

- 1 Impostare il termostato su MAX tra cotone e lino.

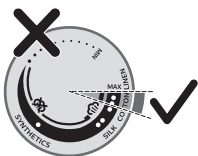

- 2 Premere e rilasciare il pulsante colpo di vapore per un getto di vapore potente, ideale per rimuovere le pieghe più ostinate.



- 3 La funzione colpo di vapore può essere utilizzata anche tenendo il ferro in posizione verticale per eliminare le pieghe dagli indumenti appesi (solo per i modelli DST2020 e DST2030).



- 4 Tirare e tendere l'indumento mentre si applica il colpo di vapore per eliminare le pieghe più ostinate (solo per i modelli DST2020 e DST2030).

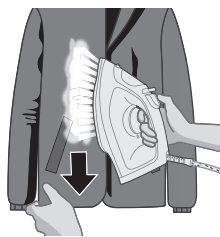

- 5 Non reggere il capo a mani nude durante la stiratura.



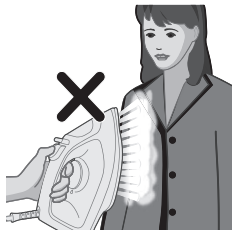

- 6 Non posizionare l'apparecchio verso se stessi o un'altra persona.

## Modalità di spegnimento automatico (DST2030)



- 1 Per garantire la massima tranquillità, l'apparecchio è in grado di raffreddarsi da solo se viene lasciato incustodito per un certo periodo di tempo.

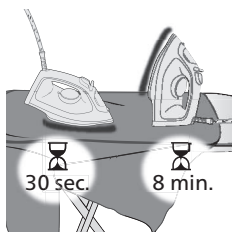

- 2 Quando l'apparecchio non viene utilizzato per più di 30 secondi e viene lasciato in posizione orizzontale, o per 8 minuti e lasciato in posizione verticale, l'apparecchio entra in modalità di spegnimento automatico.

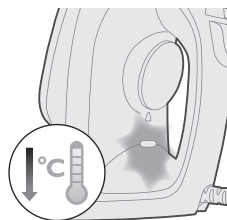

- 3 In modalità di spegnimento automatico, la temperatura dell'apparecchio diminuisce. La spia "ferro pronto" lampeggia a indicare che l'apparecchio è in modalità di spegnimento automatico. Per spegnere completamente l'apparecchio, scollegarlo dalla presa di corrente.

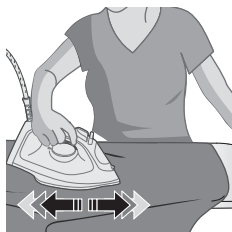

- 4 Per riscaldare nuovamente l'apparecchio, impugnarlo o muoverlo leggermente.

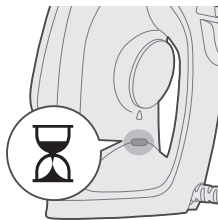

5 La spia "ferro pronto" si accende, a indicare che l'apparecchio si sta riscaldando.

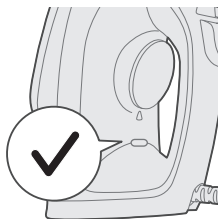

6 Quando la spia "ferro pronto" si spegne, l'apparecchio è pronto per l'uso.

## Pulizia e manutenzione

1 Assicurarsi che l'apparecchio non sia collegato alla presa di corrente.

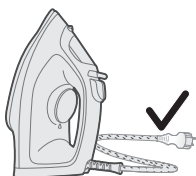
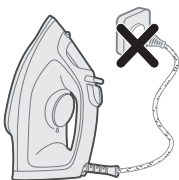

2 Assicurarsi che l'apparecchio si sia raffreddato.

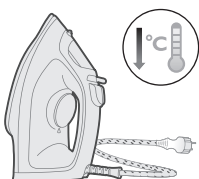

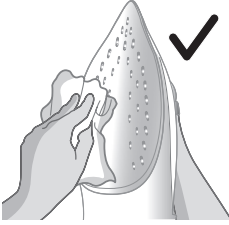

3 Rimuovere pelucchi e altri residui dalla piastra con un panno umido.



Nota: per mantenere la piastra perfettamente liscia, evitare il contatto con oggetti metallici. Non utilizzare mai spugne abrasive, aceto o altre sostanze chimiche per pulire la piastra.



4 Non pulire/sciacquare l'apparecchio sotto l'acqua corrente.

## Funzione Calc-Clean

Suggerimento: il sistema rapido di pulizia anticalcare può essere utilizzato in qualsiasi momento. Se l'acqua presente nella zona in cui si abita è molto dura, utilizzare la funzione più frequentemente.



1 Dopo un mese di utilizzo, si consiglia di eseguire la funzione Calc Clean per rimuovere le particelle di calcare depositate nel ferro, prolungarne la durata e garantire un corretto riscaldamento dell'apparecchio.

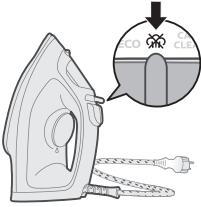

2 Assicurarsi che il ferro sia scollegato e che il selettore del vapore sia impostato sulla stiratura a secco .

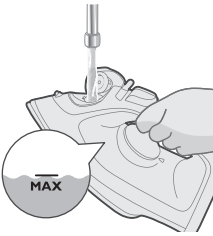

3 Riempire il serbatoio dell'acqua fino al livello massimo (MAX).

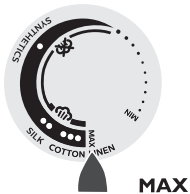

4 Impostare il termostato su MAX.

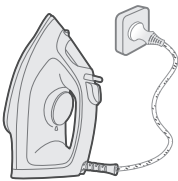

5 Collegare l'apparecchio a una presa a muro con messa a terra.

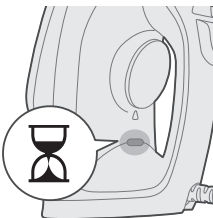

6 La spia "ferro pronto" si accende, a indicare che l'apparecchio si sta riscaldando.

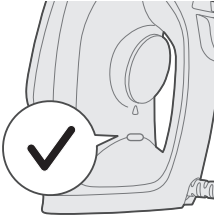

7 Attendere che la spia "ferro pronto" si spenga.

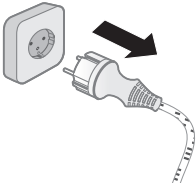

8 Scollegare il ferro.

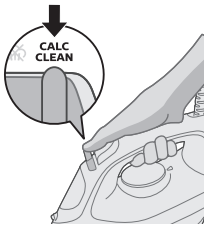

9 Spostare il selettore del vapore sulla funzione Calc-Clean e tenere premuto.



10 Tenere il ferro sopra il lavandino e scuoterlo delicatamente. Dalla piastra fuoriescono acqua calda e particelle di calcare.

Attenzione: mentre viene espulso il calcare, dalla piastra fuoriescono anche vapore e acqua bollente.

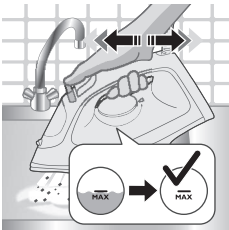

11 Continuare a scuotere il ferro fino a esaurire l'acqua del serbatoio.



**12** Collegare l'apparecchio alla presa di corrente e farlo riscaldare per asciugare la piastra. Sono necessari circa 2 minuti.

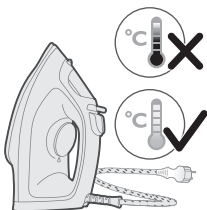

**13** Lasciare raffreddare il ferro.

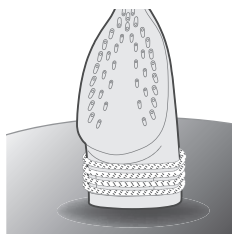

**14** Avvolgere il cavo attorno alla base dell'apparecchio.

## Conservazione

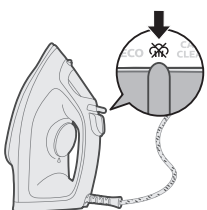

**1** Far scorrere il selettore del vapore per selezionare la modalità senza vapore (stiratura a secco) ~~OFF~~.

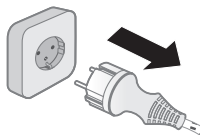

**2** Scollegare l'apparecchio dalla presa di corrente.

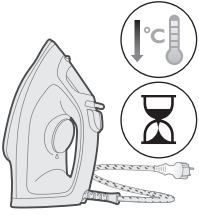

3 Lasciare raffreddare l'apparecchio.

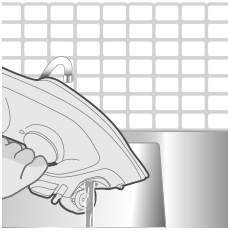

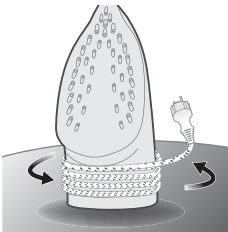

4 Svuotare il serbatoio dell'acqua rimanente.



5 Avvolgere il cavo di alimentazione attorno alla base dell'apparecchio.

## Risoluzione dei problemi

In questo capitolo vengono riportati i problemi più comuni legati all'uso dell'apparecchio. Se non è possibile risolvere il problema con le informazioni riportate di seguito, visitare il sito [www.philips.com/support](http://www.philips.com/support) per un elenco di domande frequenti oppure contattare il centro assistenza clienti del proprio paese.

Problema	Possibile causa	Soluzione
Il ferro non rimuove le pieghe dagli indumenti.	Durante la stiratura non viene erogato vapore.	Riempire il serbatoio dell'acqua e impostare il selettore del vapore su  .
L'apparecchio non eroga vapore.	Non c'è abbastanza acqua nel serbatoio.	Riempire il serbatoio dell'acqua.
	Il cursore del vapore è impostato su  .	Impostare il cursore del vapore in posizione  .



	Il ferro non è ancora abbastanza caldo per produrre vapore.	Durante la fase di riscaldamento, la spia "ferro pronto" rimane accesa. Quando il ferro è pronto all'uso, la spia si spegne.
Alcune gocce d'acqua gocciolano sul capo durante la stiratura.	La funzione colpo di vapore è stata usata troppo frequentemente in un breve lasso di tempo.	Continuare a stirare in posizione orizzontale e attendere qualche minuto prima di utilizzare nuovamente il colpo di vapore.
	Il coperchio del serbatoio dell'acqua non è stato chiuso correttamente.	Premere il coperchio fino a sentire un clic.
Il ferro non produce il colpo di vapore.	La funzione colpo di vapore è stata usata troppo frequentemente in un breve lasso di tempo.	Continuare a stirare in posizione orizzontale e attendere qualche minuto prima di utilizzare nuovamente il colpo di vapore.
	Il ferro non è ancora abbastanza caldo per la stiratura.	Attendere fino a quando la spia "ferro pronto" smette di lampeggiare e si accende a luce fissa.
	È stata aggiunta una sostanza chimica nel serbatoio dell'acqua.	Risciacquare il serbatoio dell'acqua e non versare all'interno profumi o additivi chimici.
Anche dopo aver scollegato il ferro, fuoriescono delle gocce d'acqua dalla piastra.	Il cursore del vapore è impostato su  .	Impostare il cursore del vapore in posizione  .
	Il ferro è stato messo in posizione orizzontale con dell'acqua ancora presente nel serbatoio.	Svuotare il serbatoio dell'acqua dopo l'uso, o riporre il ferro in posizione verticale.
Il ferro lascia un'impronta o una traccia lucida sui tessuti stirati.	La superficie da stirare era irregolare, come nel caso di una cucitura o di una piega dell'indumento.	Il ferro può essere usato in modo sicuro su tutti i tipi di tessuti. L'effetto lucido o l'impronta non sono permanenti e scompaiono dopo il lavaggio dell'indumento. Non effettuare la stiratura su cuciture o pieghe. Per evitare le impronte si può posizionare un panno di cotone sull'area da stirare.

# Ievads

Apsveicam ar pirkumu un laipni lūdzam Philips! Lai pilnībā izmantotu Philips piedāvātā atbalsta iespējas, reģistrējiet produktu vietnē [www.philips.com/welcome](http://www.philips.com/welcome). Pirms ierīces lietošanas uzmanīgi izlasiet šo lietotāja rokasgrāmatu, brošūru ar svarīgu informāciju un īso lietošanas pamācību. Saglabājiet šos dokumentus turpmākām uzziņām.

## Produkta pārskats

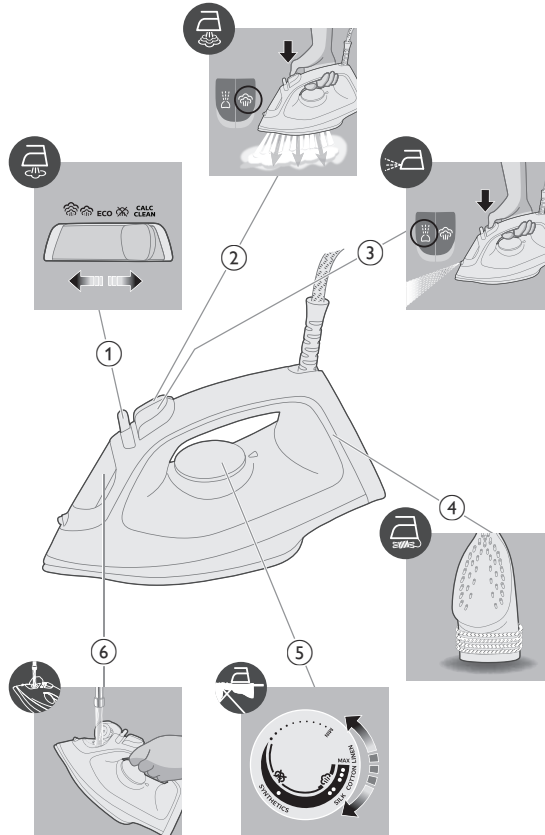

- 1 Tvaika slēdzis
- 2 Pastiprināta tvaika poga
- 3 Ūdens izsmidzināšana
- 4 Vada uztišanas vieta
- 5 Temperatūras izvēles ripa
- 6 Ūdens tvertnes vāks

## Ierīces lietošana

### Sagatavošana lietošanai

Piezīme: Lietojot gludekli pirmo reizi, tas var nedaudz kūpēt. Pēc neilga laika tas pārstās kūpēt.

#### Izmantojamais ūdens veids

Ierīce ir piemērota lietošanai ar krāna ūdeni. Tomēr, ja dzīvojat apvidū ar cietu ūdeni, mēs iesakām sajaukt vienādu daudzumu krāna ūdens ar destilētu vai demineralizētu ūdeni. Tādējādi tiks novērsta ātra kaļķakmens nogulšņu veidošanās, un tiks pagarināts ierīces darbmūžs.

**Neizmantojiet smaržas, ūdeni no žāvētāja, etiķi, cieti, atkaļķošanas līdzekļus, gludināšanas palīg līdzekļus, ķīmiski atkaļķotu ūdeni vai citas ķīmikālijas, jo tās var izraisīt ūdens smidzināšanos, brūnus traipus vai ierīces bojājumus.**

### Ūdens tvertnes uzpildīšana

- 1 Nepievienojiet ierīci strāvas avotam.

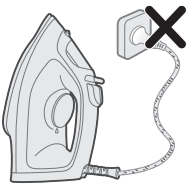

- 2 Pārliecinieties, ka ierīce ir atdzisusi.

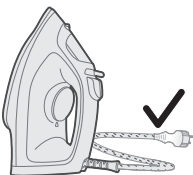

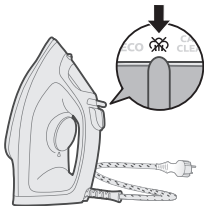

3 Pārbīdiet tvaika slēdzi pa labi, lai pārslēgtu režīmā bez tvaika (sausā gludināšana) .

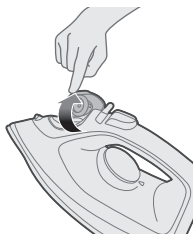

4 Atveriet ūdens tvertnes vāku.

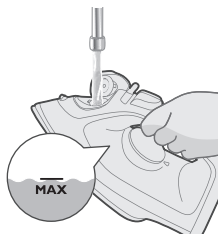

5 Piepildiet ūdens tvertni ar ūdeni līdz līmeņa atzīmei MAX.

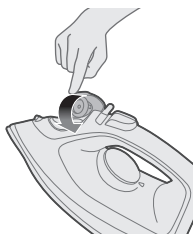

6 Cieši aizveriet ūdens tvertnes vāku.

## Temperatūras noregulēšana



MAX  
LINS



● ● ●  
KOKVILNA



● ●  
ZĪDS

ECO

●  
SINTĒTIKA

ECO



ECO iestatījums: tiek padota minimāla pastāvīga tvaika plūsma mazāk saburzītu apģērbu gludināšanai. Šis iestatījums ļauj arī ietaupīt enerģiju.



Divi tvaika mākonīši: tiek padota lielāka pastāvīga tvaika plūsma noturīgāku burzījumu gludināšanai.



Trīs tvaika mākonīši: tiek padota maksimāla pastāvīga tvaika plūsma grūti likvidējamu burzījumu gludināšanai.

## Ierīces lietošana

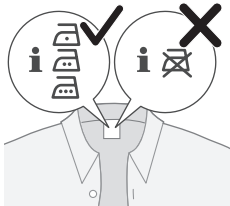

- 1 Pārbaudiet apģērba kopšanas etiķeti un apskatiet norādījumus par gludināšanu.

## 190 Latviešu

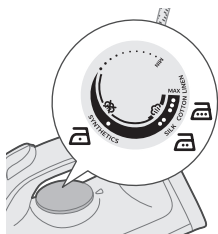

- 2 Noregulējiet temperatūras ciparrīpu atbilstošā stāvoklī, pagriežot to pret attiecīgo gludināšanas temperatūras norādi.

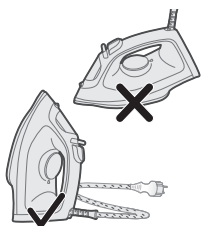

- 3 Atbalstiet gludekli uz aizmugurējās daļas.

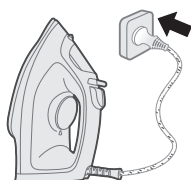

- 4 Pievienojiet ierīci iezemētai elektrotīkla kontaktligzdai.

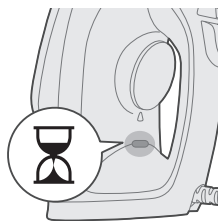

- 5 Iedegas uzkarsēšanas lampiņa, norādot, ka gludeklis tiek uzkarsēts.

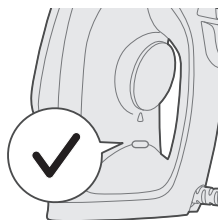

- 6 Kad uzkarsēšanas lampiņa nodziest, nedaudz nogaidiet, pirms sākat gludināšanu. Gludināšanas laikā uzkarsēšanas lampiņa periodiski iedegas.

## Bez tvaika/sausā gludināšana

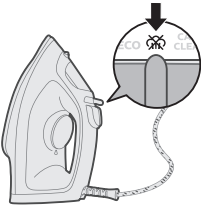

- 1 Pārslēdziet tvaiku iestatījumā bez tvaika.

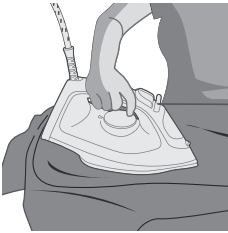

- 2 Pēc īsa brīža gludināšanas laikā tvaiks vairs netiek padots.

## Ūdens izsmidzināšana

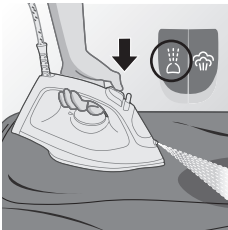

- 1 Pārslēdziet tvaiku iestatījumā bez tvaika. Nospiediet un atlaižiet ūdens izsmidzināšanas pogu, lai padotu ūdens strūklu vai izsmidzinātu ūdeni grūti likvidējamu burzījumu gludināšanai.

## Papildu tvaiks

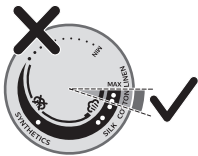

- 1 Pārslēdziet temperatūras ripu iestatījumā MAX, pozīcijā starp kokvilnu un līnu.



2 Nospiediet un atlaidiet papildu tvaika pogu, lai iegūtu spēcīgu tvaika strūklu un likvidētu grūti izgludināmas krokas.



3 Papildu tvaika funkciju varat izmantot, arī turot gludekli vertikālā pozīcijā. Tas palīdz izgludināt burzījumus uz pakarināta apģērba vai audumiem (tikai modeļiem DST2020 un DST2030).

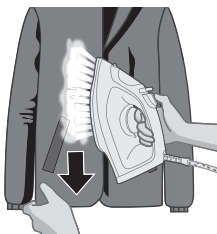

4 Lai izgludinātu grūti likvidējamus burzījumus, tvaika padeves laikā pavelciet un pastiepiet audumu (tikai modeļiem DST2020 un DST2030).



5 Neizmantojiet savu roku kā atbalsta virsmu gludināšanas laikā.

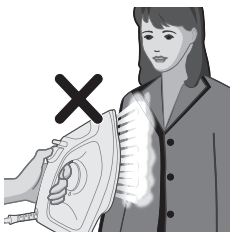

6 Nevērsiet ierīci pret sevi vai citiem cilvēkiem.



## Automātiska izslēgšanās (DST2030)

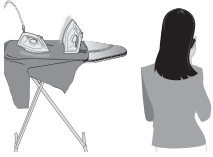

- 1 Lai jums nebūtu lieki jāsatraucas, ierīce atdziest automātiski, ja tā noteiktu laika brīdi netiek izmantota.

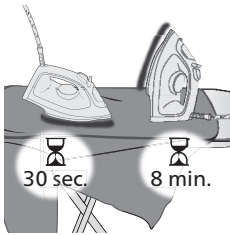

- 2 Ja ierīce netiek izmantota ilgāk par 30 sekundēm, kad tā ir novietota uz gludināšanas virsmas, vai 8 minūtes, novietota uz aizmugurējās daļas/bāzes, ierīce pārslēdzas automātiskās izslēgšanas režīmā.

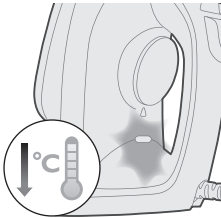

- 3 Automātiskās izslēgšanas režīmā ierīces temperatūra pazeminās. Uzkarsēšanas lampiņa nemitīgi mirgo, norādot, ka ierīce pārslēgusies automātiskās izslēgšanas režīmā. Lai pilnībā izslēgtu ierīci, atvienojiet to no kontaktligzdas.

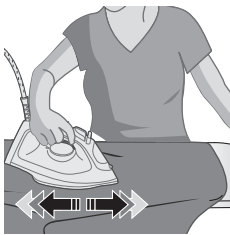

- 4 Lai ierīce atkal sāktu uzsilt, paceliet to vai nedaudz pakustiniet.

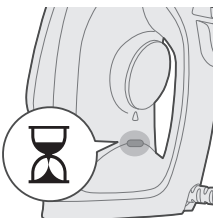

- 5 Iedegas uzkarsēšanas lampiņa, norādot, ka ierīce tiek uzkarsēta.

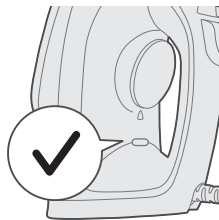

6 Kad uzkarsēšanas lampiņa nodziest, ierīce ir gatava lietošanai.

## Tīrīšana un kopšana

1 Pārliecinieties, ka ierīce nav pieslēgta elektrotīklam.

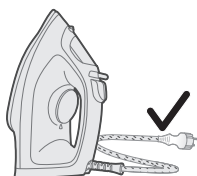
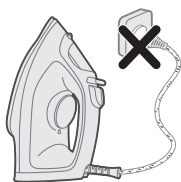

2 Pārliecinieties, ka ierīce ir atdzisusi.

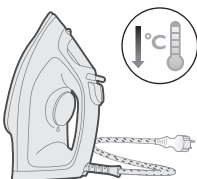

3 Uz gludināšanas virsmas esošās plūksnas un nosēdumus notīriet ar mitru drānu.

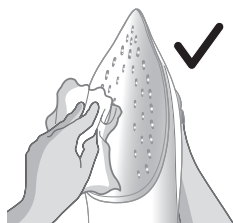



Piezīme: Saglabāriet gludināšanas virsmu gludu, izvairoties no saskares ar metāla priekšmetiem. Nekad neizmantojot beržamo, etiķi vai citas ķīmikālijas darba virsmas tīrīšanai.

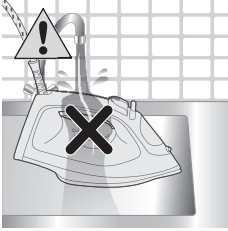

4 Nemazgājiet/netīriet ierīci tekošā ūdenī.

## Calc-Clean funkcija

Padoms. Ātrās katlakmens notīrīšanas funkciju var izmantot jebkurā laikā. Ja dzīvojat reģionā, kur ir ciets ūdens, izmantojiet šo funkciju biežāk.



1 Kad ierīce ir izmantota 1 mēnesi, iesakām izpildīt Calc-Clean funkciju, lai iztīrītu no ierīces sakrājušos katlakmeni, pagarinātu tās kalpošanas laiku un nodrošinātu, ka ierīce var uzkarst.

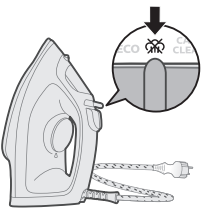

2 Pārliecinieties, ka gludekļa kontaktdakša ir atvienota un tvaika iestatījums ir pārslēgts režīmā bez tvaika (sausā gludināšana) .

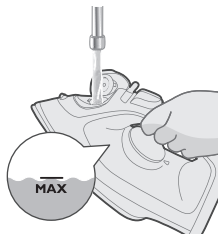

3 Piepildiet ūdens tvertni ar ūdeni līdz MAX atzīmei.

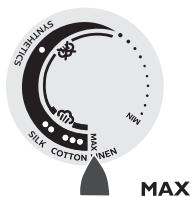

4 Pagrieziet temperatūras regulatoru pret MAX iezīmi.

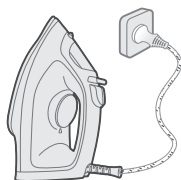

5 Pievienojiet ierīci iezemētai sienas kontaktligzdai.

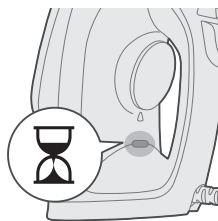

6 Iedegas uzkaršanās lampiņa, norādot, ka ierīce tiek uzkaršēta.

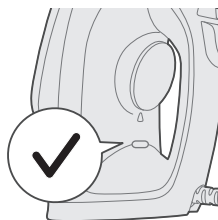

7 Nogaidiet, līdz uzkaršanās lampiņa nodziest.

8 Atvienojiet gludekļa kontaktdakšu.

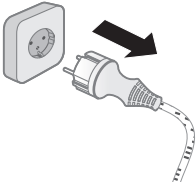

9 Pārbīdiet tvaika slēdzi pozīcijā Calc-Clean un turiet to.

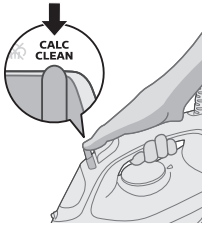

10 Turiet gludekli virs izlietnes un saudzīgi pakratiet gludekli. No gludināšanas virsmas izdalās ūdens un katlakens daļiņas.



Uzmanību! Lai gan tiek izskalots katlakens, no gludināšanas virsmas izplūst arī tvaiks un verdošs ūdens.

11 Turpiniet kratīt gludekli, līdz viss ūdens, kas atradās tvertnē, ir izvadīts.

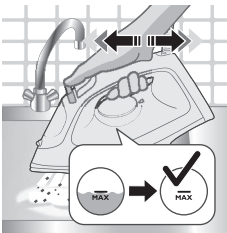

12 Iespraudiet ierīces kontaktdakšu un ļaujiet ierīcei uzsilt, lai nožāvētu gludināšanas virsmu. Process var ilgt aptuveni 2 minūtes.

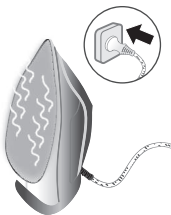

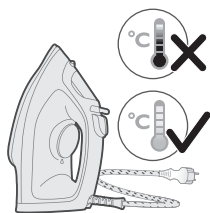

13 Ļaujiet gludeklim atdzist.

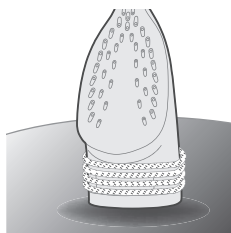

14 Aptiniet vadu ap ierīces aizmugurējo daļu.

## Glabāšana

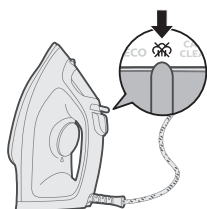

1 Pārbīdiet tvaika slēdži, lai pārslēgtu režīmā bez tvaika (sausā gludināšana) ~~☒~~.

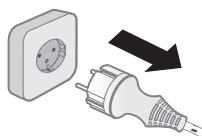

2 Atvienojiet ierīci no elektrotīkla.

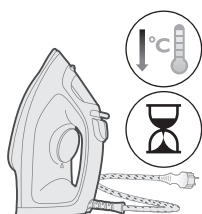

3 Ļaujiet ierīcei atdzist.

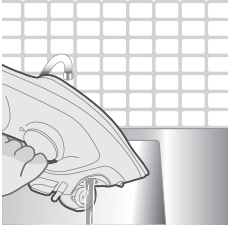

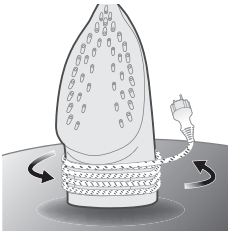

4 Izlejiet no ūdens tvertnes atlikušo ūdeni.





5 Aptiniet strāvas vadu ap ierīces korpusu.

## Problēmu novēršana

Šajā nodaļā apkopota informācija par izplatītām problēmām, kas var rasties ierīces darbībā. Ja nevarat novērst problēmu, izmantojot tālāk sniegto informāciju, apmeklējiet vietni [www.philips.com/support](http://www.philips.com/support), lai skatītu bieži uzdoto jautājumu sarakstu, vai arī sazinieties ar klientu apkalpošanas centru savā valstī.

Problēma	Iespējamais cēlonis	Risinājums
Gludeklis nevar izgludināt apgērba krokas.	Gludināšanas laikā neizplūst tvaiks.	Uzpildiet ūdens tvertni ar ūdeni un pārbīdiet tvaika slīdslēdzi pozīcijā  .
Gludeklis neizdala tvaiku.	Ūdens tvertnē nav pietiekami daudz ūdens.	Piepildiet ūdens tvertni.
	Tvaika slīdslēdzis atrodas pozīcijā  .	Pārbīdiet tvaika slīdslēdzi pozīcijā  .
	Gludeklis nav pietiekami uzkaršis, lai veidotu tvaiku.	Kamēr gludeklis uzsilst, nemirgojot deg uzkaršēšanas lampiņa. Kad gludeklis ir gatavs lietošanai, lampiņa nodziest.
Gludināšanas laikā ūdens pil uz auduma.	Papildu tvaika funkcija ir izmantota pārāk bieži ļoti īsā laikposmā.	Turpiniet gludināšanu horizontālā stāvoklī un pagaidiet, pirms atkal lietojat papildu tvaiku.
	Ūdens tvertnes vāciņš nav pareizi aizvērts.	Uzspiediet uz vāciņa, līdz atskan klikšķis.

## 200 Latviešu

Gludeklis nerada papildu tvaiku.	Papildu tvaika funkcija ir izmantota pārāk bieži ļoti īsā laikposmā.	Turpiniet gludināšanu horizontālā stāvoklī un pagaidiet, pirms atkal lietojat papildu tvaiku.
	Gludeklis vēl nav pietiekami uzkaršis gludināšanai.	Uzgaidiet, līdz uzkaršēšanas lampa pārtrauc mirgot un deg nemirgojot.
	Ūdens tvertnē ir ielietas ķīmikālijas.	Izskalojiet ūdens tvertni un neļaujiet tajā smaržas vai ķīmikālijas.
Pēc gludekļa atvienošanas no strāvas tīkla no gludināšanas virsmas pil ūdens.	Tvaika slīdslēdzis atrodas pozīcijā  .	Pārbīdiet tvaika slīdslēdzi pozīcijā  .
	Gludeklis ir ticis novietots horizontāli, kamēr ūdens tvertnē joprojām bija ūdens.	Pēc lietošanas iztukšojiet ūdens tvertni vai glabājiet gludekli vertikālā pozīcijā.
Gludeklis uz auduma veido spīdumu vai atstāj nospiedumus.	Gludināmā virsma nav bijusi līdzena, piemēram, esat gludinājis auduma šuves vai ieloces.	Gludeklis ir drošs lietošanai visiem gludināmiem audumiem. Spīdums vai nospiedumi nav paliekoši un pēc apgērba izmazgāšanas izzudīs. Centieties negludināt pāri vilēm vai ielocēm. Varat arī gludināmās vietas pārklāt ar kokvilnas drānu, lai neveidotos nospiedumi.



# Įvadas

Sveikiname įsigijus „Philips“ gaminį ir sveiki atvykę! Norėdami pasinaudoti „Philips“ siūloma pagalba, užregistruokite savo gaminį adresu [www.philips.com/welcome](http://www.philips.com/welcome). Prieš naudodamiesi prietaisu atidžiai perskaitykite šį naudotojo vadovą, svarbios informacijos lapelį ir trumpąjį naudojimo pradžios vadovą. Saugokite juos, nes gali prireikti ateityje.

## Gaminio apžvalga

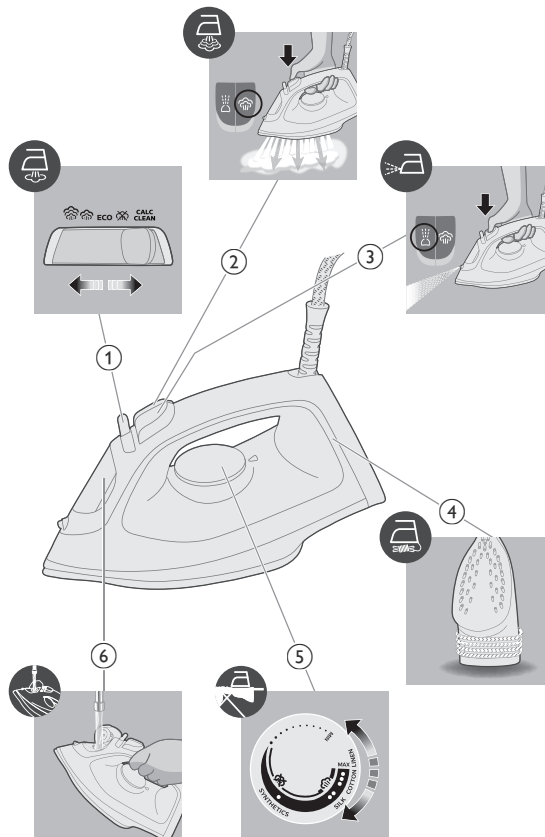

- 1 Garų režimo perjungiklis
- 2 Garo srovės mygtukas
- 3 Vandens purškimas
- 4 Laido susukimas
- 5 Temperatūros diskelis
- 6 Vandens bakelio dangtis

## Prietaiso naudojimas

### Paruošimas naudoti

Pastaba: Naudojant pirmą kartą iš lygintuvo gali pasirodyti garų. Netrukus jie nustos sklisti.

#### **Naudojamas vanduo**

Prietaisas naudojamas su vandentiekio vandeniu. Tačiau, jei gyvenate vietovėje, kurioje vanduo yra kietas, rekomenduojame sumaišyti vienodą kiekį vandentiekio ir distiliuoto arba demineralizuoto vandens. Tokiu būdu kalkių nuosėdos susidarys lėčiau ir pailginsite prietaiso tarnavimo laiką.

**Nenaudokite kvėpalų, vandens iš džiovyklės, acto, krakmolo, kalkių šalinimo priemonių, pagalbinių lyginimo priemonių, cheminiu būdu nuo kalkių išvalyto vandens ir kitų chemikalų, nes dėl jų vanduo gali imti taškytis, palikti rudų dėmių arba sugadinti prietaisą.**

### Vandens bakelio pripildymas

- 1 Neprijunkite prietaiso prie elektros lizdo.

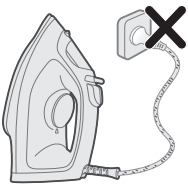

2 Įsitinkite, kad prietaisas yra atvėsęs.

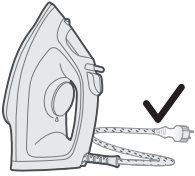

3 Paslinkite garų režimo perjungiklį dešinėn, kad nebūtų pasirinktas joks garų režimas (sausasis lyginimas) ~~☒~~.

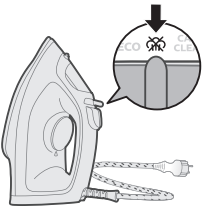

4 Atidarykite vandens bakelio dangtį.



5 Į vandens bakelį pripilkite vandens iki MAX žymos.

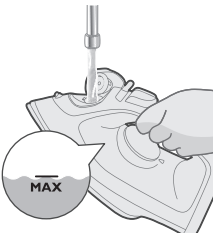

6 Sandariai uždarykite vandens bakelio dangtį.

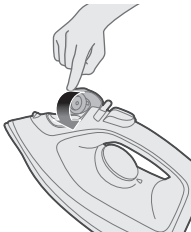

## Temperatūros nustatymas



	„MAX“ LINAS	
	● ● ● MEDVILNĖ	
	● ● ŠILKAS	<b>ECO</b>
	● SINTETIKA	



ECO nustatymas: nuolatos leidžiamas mažiausias, pastovus garų kiekis, kai drabužiai mažiau suglamžyti. Be to, nustačius šį nustatymą taupoma energija.



Du garų debesys: nuolatos leidžiamas pastovesnis garų kiekis, kai raukšlės sunkiai lyginamos.



Trys garų debesys: nuolatos leidžiamas didžiausias, pastovus garų kiekis, kai raukšlės sunkiai įveikiamos.

## Prietaiso naudojimas

- 1 Rekomenduojamas lyginimo rekomendacijas žiūrėkite gaminio etiketėje.

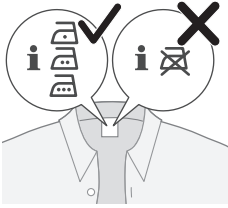

- 2 Nustatykite reikiamą lyginimo temperatūrą sukdami temperatūros nustatymo diską iki atitinkamos padalos.

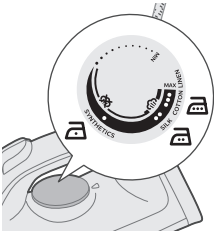

- 3 Padėkite lygintuvą ant atramos.

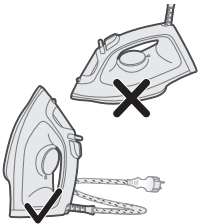

- 4 Įjunkite prietaisą į žemintą sieninį el. lizdą.

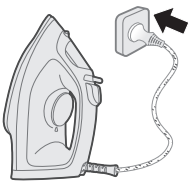

- 5 Įsijungs paruošto lygintuvo lemputė, nurodanti, kad lygintuvas kaista.

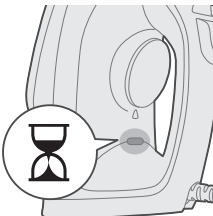

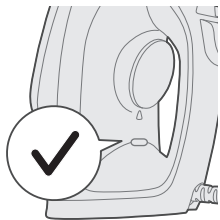

- 6 Išsijungus paruošto lygintuvo lemputei, truputį palaukite ir tik tada pradėkite lyginti. Lyginant paruošto lygintuvo lemputė kartkartėmis vis įsijungs.

## Be garų / sausasis lyginimas

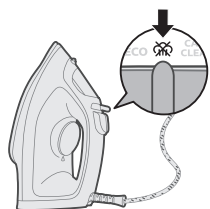

- 1 Nustatykite lyginti be garų.

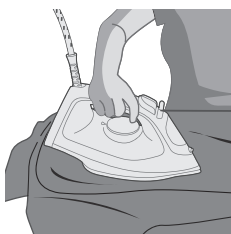

- 2 Po kurio laiko lyginant garų nebebus.

## Vandens purškimas

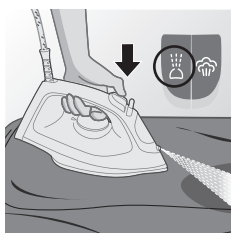

- 1 Nustatykite lyginti be garų. Paspauskite ir atleiskite vandens purškimo mygtuką, kad pasklistų migla ir išlygintumėte sunkiai įveikiamas raukšles.

## Garų srovė

- 1 Nustatykite temperatūros ratuką ties MAX nustatymu, tarp medvilnės ir lino.

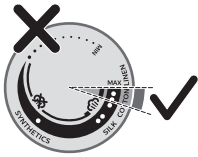

- 2 Paspauskite ir atleiskite garų srovės mygtuką, kad stipriu garų pliūpsniu pašalintumėte sunkiai įveikiamas raukšles.



- 3 Garų srovės funkciją galima naudoti lygintuvą laikant vertikaliai ir lyginant pakabintų drabužių raukšles (tik DST2020 ir DST2030).

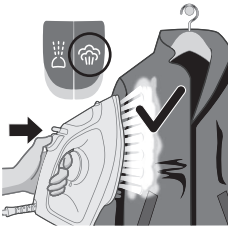

- 4 Patraukite ir ištempkite drabužį įjungę garų srovę, kad išlygintumėte sunkiai įveikiamas raukšles (tik DST2020 ir DST2030).

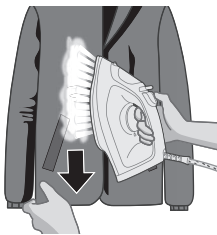

- 5 Lygindami nelaikykite plikomis rankomis.





6 Nenukreipkite prietaiso į save ar kitą asmenį.

## Aut. išsijungimas (DST2030)



1 Būkite ramūs, nes prietaisas atvės pats tam tikrą laikotarpį jį palikus be priežiūros.

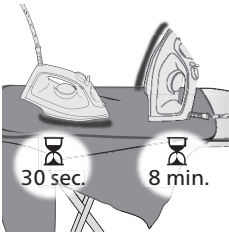
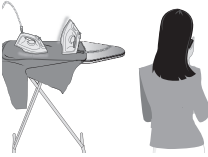

2 Jei prietaisas nenaudojamas ir yra pastatytas ant lygintuvo pado ilgiau nei 30 sek. arba 8 min. pastatytas ant atramos / pagrindo, prietaise įjungiamas automatinio išsijungimo režimas.

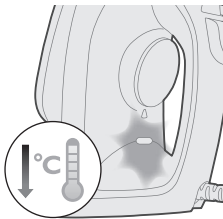

3 Prietaiso temperatūra nukris įsijungus automatinio išsijungimo režimui. Be to, nuolat mirksės paruošto lygintuvo lemputė, nurodanti, kad prietaisas veikia automatinio išsijungimo režimu. Norėdami visiškai išjungti prietaisą, atjunkite jį nuo elektros lizdo.

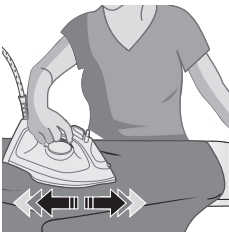

4 Jei norite, kad prietaisas vėl imtų kaisti, pakelkite jį arba truputį pajudinkite.



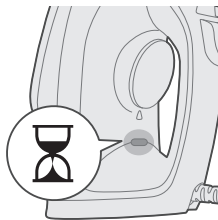

5 Įsijungs paruošto lygintuvo lemputė, nurodanti, kad prietaisas kaista.

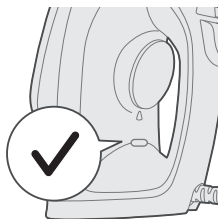

6 Kai tik paruošto lygintuvo lemputė išsijungs, prietaisas bus paruoštas naudoti.

## Valymas ir priežiūra

1 Įsitikinkite, kad prietaisas neprijungtas prie el. lizdo.

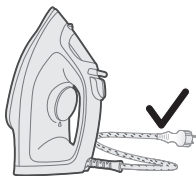
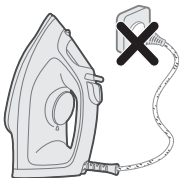

2 Įsitikinkite, kad prietaisas atvėso.

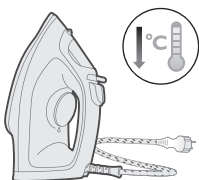

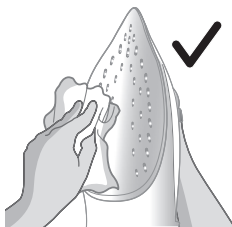

- 3 Drėgnu skudurėliu nuvalykite kalkių nuosėdas nuo lygintuvo pado.

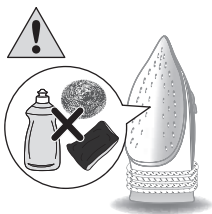

Pastaba: Norėdami apsaugoti padą, stenkitės, kad jis nesiliestų su metaliniais daiktais. Valydami padą niekada nenaudokite šurkščių kempinių, acto ar kitų cheminių medžiagų.

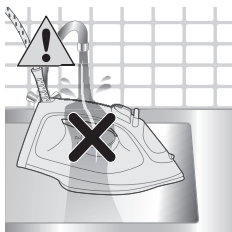

- 4 Neplaukite / nevalykite prietaiso tekančiu vandeniu.

## Kalkių nuosėdų šalinimo funkcija

Patarimas. Greitojo kalkių šalinimo funkciją galima naudoti bet kada. Jei gyvenate vietovėje, kurioje vanduo yra kietas, naudokite šią funkciją dažniau.

- 1 Panaudojus prietaisą 1 mėn., rekomenduojama pašalinti kalkių nuosėdas iš prietaiso, kad jis ilgiau tarnautų ir gerai kaistų.



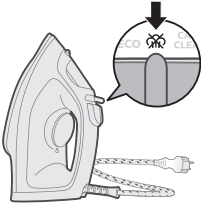

- 2 Įsitinkinkite, kad lygintuvas yra atjungtas nuo el. lizdo, o garų reguliatorius yra nustatytas į lyginimą be garų (sausasis lyginimas) .

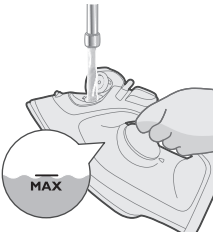

- 3 Pripilkite į vandens bakelį vandens iki žymos MAX.

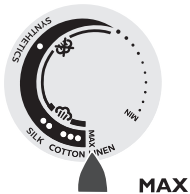

- 4 Temperatūros disku nustatykite „MAX“ temperatūrą.

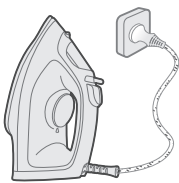

- 5 Prietaisą įjunkite į žemintą sieninį el. lizdą.

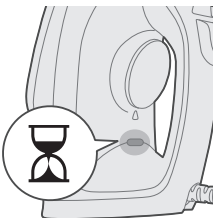

- 6 Įsijungs paruošto lygintuvo lemputė, nurodanti, kad prietaisas kaista.

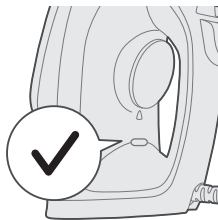

7 Palaukite, kol paruošto lygintuvo lemputė išsijungs.

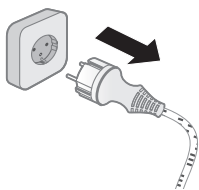

8 Atjunkite lygintuvą nuo el. lizdo.

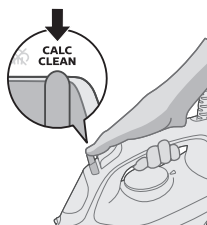

9 Pastumkite garų režimo perjungiklį į kalkių nuosėdų šalinimo padėtį ir palaikykite.



10 Laikykite lygintuvą virš kriauklės ir švelniai jį pakratykite. Iš lygintuvo pado išbėgs karštas vanduo ir kalkių nuosėdų dalelės.

Dėmesio! Plaunant kalkes iš lyginimo pado gali ištekėti garų ir verdančio vandens.

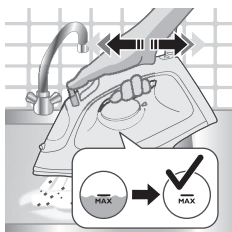

11 Dar pakratykite lygintuvą, kol iš bakelio išbėgs visas vanduo.

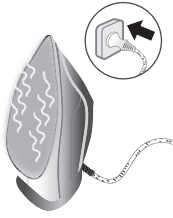

**12** Įjunkite lygintuvą į el. lizdą ir palaukite, kol jis įkais, kad nudžiūtų lygintuvo padas. Tai trunka apie 2 min.

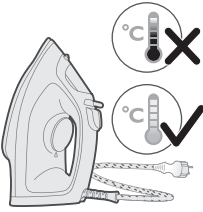

**13** Palaukite, kol lygintuvas atvės.

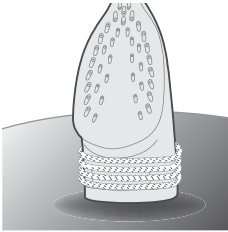

**14** Apvyniokite maitinimo laidą aplink lygintuvo atramą.

## Laikymas

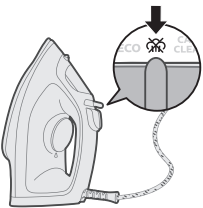

**1** Paslinkite garų režimo perjungiklį, kad nebūtų pasirinktas joks garų režimas (sausasis lyginimas) ~~ON~~.

**2** Atjunkite prietaisą nuo elektros lizdo.

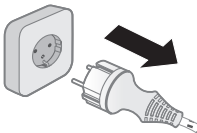

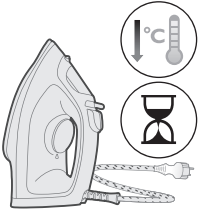

3 Leiskite prietaisui atvėsti.

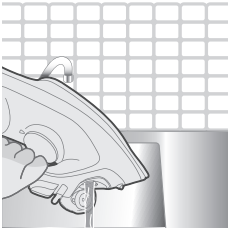

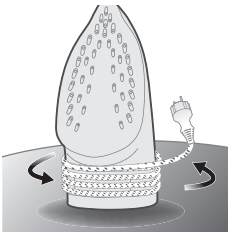

4 Iš vandens bakelio išpilkite likusį vandenį.



5 Maitinimo laidą apvyniokite aplink prietaiso korpusą.

## Trikčių diagnostika

Šiame skyriuje trumpai aprašomos dažniausios problemos, kurios kyla naudojant šį prietaisą. Jei toliau pateikta informacija nepadeda išspręsti problemos, apsilankykite adresu [www.philips.com/support](http://www.philips.com/support), ten rasite dažnai užduodamų klausimų sąrašą, arba kreipkitės į savo šalies klientų aptarnavimo centrą.

Problema	Galima priežastis	Sprendimas
Lygintuvas neišlygina drabužio raukšlių.	Lyginant nesklinda garai.	Pripildykite vandens bakelį ir nustatykite garų reguliatorių į padėtį  .
Lygintuvas neskleidžia garų.	Bakelyje nepakanka vandens.	Pripildykite vandens bakelį.
	Garų reguliatorius yra nustatytas į padėtį  .	Garų reguliatorių nustatykite į padėtį  .
	Lygintuvas nepakankamai įkaitęs, kad generuotų garus.	Kol lygintuvas kaista, nuolat šviečia „paruošto lygintuvo“ lemputė. Lygintuvą galima naudoti, kai lemputė išsijungia.

Lyginant vandens lašeliai laša ant audinio.	Per trumpą laikotarpį per dažnai naudojote garų srovės funkciją.	Lyginkite toliau horizontalioje padėtyje ir truputį palaukite, kol vėl galėsite naudoti garų srovės funkciją.
	Netinkamai uždarėte vandens bakelio dangtį.	Spauskite dangtelį, kol išgirsite spragtelėjimą.
Lygintuvas neskleidžia garų srovės.	Per trumpą laikotarpį per dažnai naudojote garų srovės funkciją.	Lyginkite toliau horizontalioje padėtyje ir truputį palaukite, kol vėl galėsite naudoti garų srovės funkciją.
	Lygintuvas nepakankamai įkaitęs, kad galėtumėte lyginti.	Palaukite, kol „paruošto lygintuvo“ lemputė nustos mirksėti ir pradės nuolat šviesti.
	Į vandens bakelį įpylėte cheminių medžiagų.	Išskalaukite vandens bakelį ir nepilkite į jį jokių kvepalų ar cheminių medžiagų.
Atjungus lygintuvą nuo elektros lizdo, iš jo pado laša vanduo.	Garų reguliatorius yra nustatytas į padėtį  .	Garų reguliatorių nustatykite į padėtį  .
	Lygintuvas buvo pastatytas horizontaliai, kai vandens bakelyje vis dar buvo vandens.	Panaudoję ištuštinkite vandens bakelį arba lygintuvą laikykite vertikalioje padėtyje.
Lygintuvas ant drabužių palieka blizgesį ar žymes.	Lyginamas paviršius nebuvo lygus, nes, pavyzdžiui, lyginote per drabužio siūlę ar klostę.	Lygintuvą saugu naudoti visiems lyginamiems drabužiams. Blizgesys ar žymės nėra ilgalaikiai ir pradings išplovus drabužį. Venkite lyginti per siūles ar klostes. Taip pat ant lygintinos vietos galite uždėti medvilninį audinį, kad išvengtumėte įspaudų.

## Bevezetés

A Philips köszönti Önt! Gratulálunk a vásárláshoz! A Philips által biztosított teljes körű támogatáshoz regisztrálja termékét a [www.philips.com/welcome](http://www.philips.com/welcome) oldalon. Kérjük, a készülék használata előtt figyelmesen olvassa el ezt a felhasználói kézikönyvet, a Fontos tudnivalók című ismertetőt és a rövid üzembe helyezési útmutatót. Őrizze meg őket későbbi használatra.

## A termék rövid bemutatása

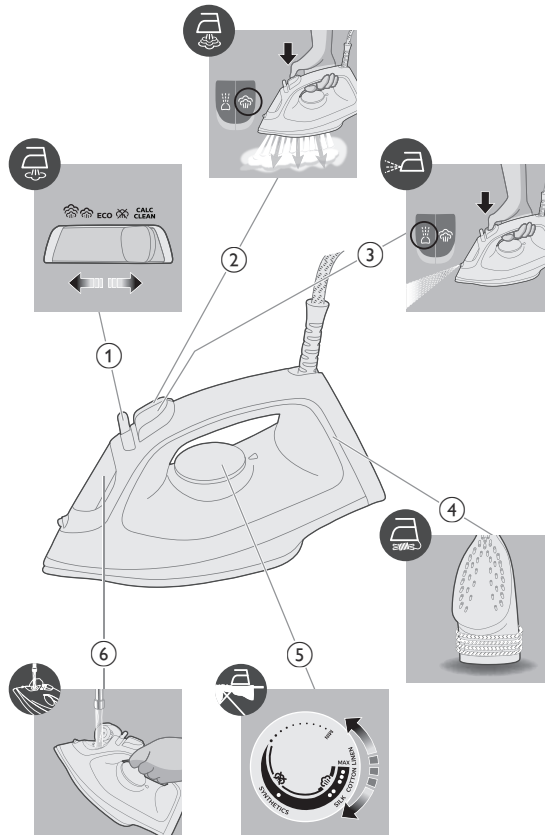



- 1 Gőzválasztó
- 2 Gőzlövet gomb
- 3 Vízipermet
- 4 Vezetékfeltekerés
- 5 Hőfokszabályozó
- 6 A víztartály fedele

## A készülék használata

### Előkészítés a használatra

Megjegyzés: Elképzelhető, hogy a vasaló az első használatkor rövid ideig egy kis gőzt bocsát ki. Ez rövid idő alatt megszűnik.

#### A használandó víz típusa

A készüléket csapvízzel való használatra tervezték. Ha azonban kemény vizet tartalmazó területen él, javasoljuk, hogy a csapvízhez adjon azonos mennyiségű desztillált vagy ioncserélt vizet. Ez megakadályozza a gyors vízkőlerakódást, és meghosszabbítja a készülék élettartamát.

**Ne adjon hozzá parfümöt, szárítógépből származó vizet, ecetet, keményítőt, vízkőmentesítő szert, vasalási segédanyagokat, vegyileg vízkőmentesített vizet és más vegyi anyagokat, mivel ezek vízszivárgáshoz, barna foltok képződéséhez, illetve a készülék károsodásához vezethetnek.**

### A víztartály feltöltése

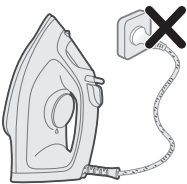

- 1 A készülék ne csatlakozzon a hálózati áramforráshoz.

2 Győződjön meg róla, hogy a készülék lehűlt.

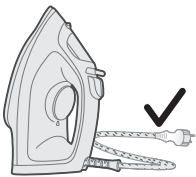

3 A gőzváltó jobbra csúsztatásával válassza ki a „nincs gőz” (száraz vasalás) opciót ~~☒~~.

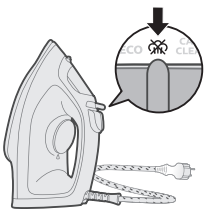

4 Nyissa fel a víztartály fedelét.

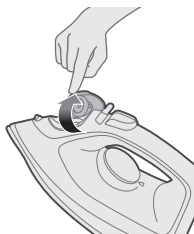

5 Töltse fel a víztartályt a benne található MAX jelzésig.

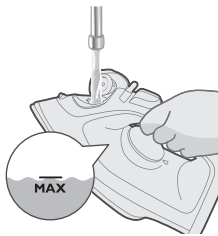

6 Zárja le szorosan a víztartály fedelét.

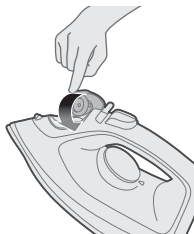

## A hőmérséklet beállítása



	MAX VÁSZN	
	● ● ● PAMUT	
	● ● SELYEM	<b>ECO</b>
	● MŰSZÁLAS ANYAGOK	

ECO



ECO-fokozat: Kevésbé gyűrött ruhadarabok esetén a vasaló folyamatosan minimális mennyiségű gőzt bocsát ki. Ez a beállítás energiát takarít meg.



Két gőzfelhő: A makacs gyűrődések eltávolításához a vasaló több gőzt bocsát ki folyamatosan.



Három gőzfelhő: A makacs gyűrődések eltávolításához a vasaló folyamatosan maximális mennyiségű gőzt bocsát ki.

## A készülék használata

1 Ellenőrizze a ruhacímkén a megfelelő vasalást.

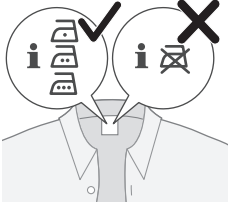

2 A megfelelő hőmérséklet-jelzésre forgatva állítsa a hőfokszabályozót a kívánt vasalási hőmérsékletre.

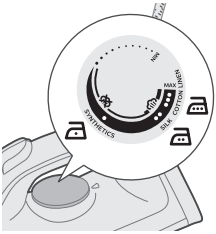

3 Állítsa a vasalót a sarkára.

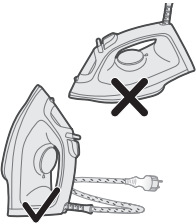

4 Csatlakoztassa a készüléket földelt fali aljzathoz.

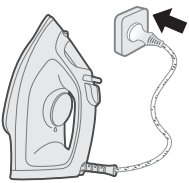

5 A vasoló készületi jelzőfényje világítani kezd, jelezve, hogy a vasaló melegszik.

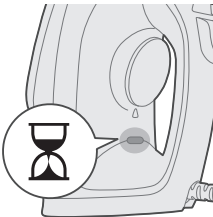

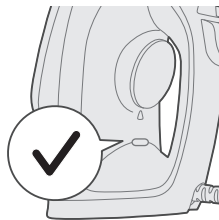

- 6 Miután a vasaló készenléti jelzőfénye kialszik, várjon egy kicsit, mielőtt hozzáfogna a vasaláshoz. Vasalás közben a készenléti jelzőfény időről időre világítani kezd.

## Nincs gőz/száraz vasalás

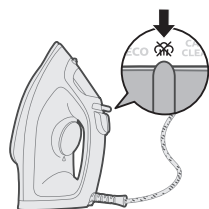

- 1 Állítsa a gőzbeállítást „nincs gőz” értékre.

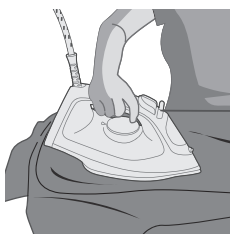

- 2 Rövid idő elteltével vasalás közben megszűnik a gőzkibocsátás.

## Vízpermet

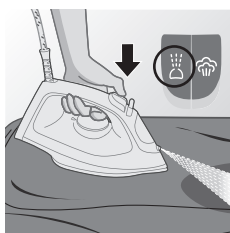

- 1 Állítsa a gőzbeállítást „nincs gőz” értékre. A makacs gyűrődések vízpermettel való eltávolításához nyomja meg, majd engedje fel a vízpermet gombot.

## Gőzlövet

- 1 Állítsa a hőfokszabályzót MAX állásba a pamut és a vászon jelzés között.

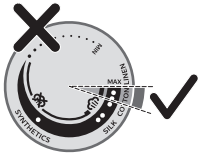

- 2 A gőzlövet gombot nyomja le, majd engedje fel az erőteljes gőzlövetért, mellyel eltávolíthatja a makacs gyűrődéseket.



- 3 A gőzlövet funkció függőleges helyzetű vasalóval is használható. Így a felfüggesztett ruhadarabok gyűrődéseinek kisimítására is alkalmas (csak a DST2020 és DST2030 esetén).

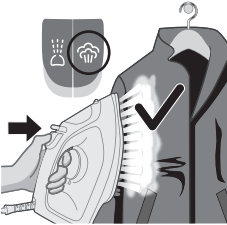

- 4 A makacs gyűrődések eltávolításához húzza meg és feszítse ki a ruhát, miközben gőzlövet alkalmaz (csak a DST2020 és DST2030 esetén).

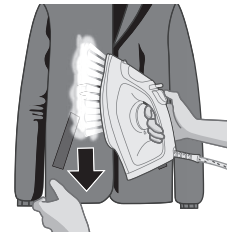

- 5 Vasalás közben ne használja támasztófelületként a kezét.



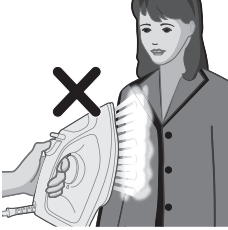

- 6 Ne tartsa a készüléket saját maga vagy más személyek irányába.

## Automatikus kikapcsolás (DST2030)

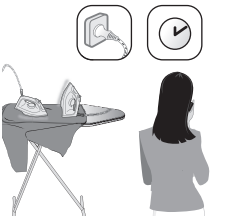

- 1 A biztonságos működés érdekében a készülék magától lehűl, ha egy ideig felügyelet nélkül marad.

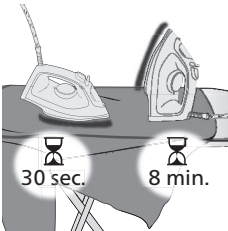

- 2 Ha nincs használatban a talpán állva 30 másodpercnél hosszabb ideig, vagy a sarkán állva 8 percnél hosszabb ideig, a készülék automatikus kikapcsolás módba lép.

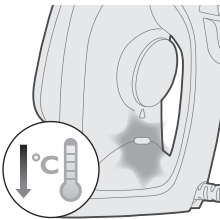

- 3 A készülék hőmérséklete automatikus kikapcsolás üzemmódban csökken. A vasaló készletléti jelzőfénye folyamatos villogással jelzi, hogy a készülék automatikus kikapcsolás állapotban van. A készülék teljes kikapcsolásához húzza ki a csatlakozódugóját az aljzatból.

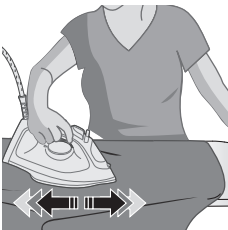

- 4 A készülék újbóli felmelegítéséhez emelje fel vagy kicsit mozgítsa meg a készüléket.

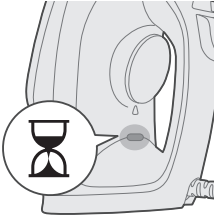

5 A készülék készenléti jelzőfénye világítani kezd, jelezve, hogy a vasaló melegszik.

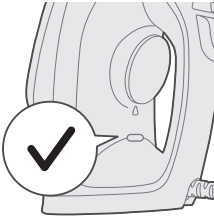

6 Ha a vasaló készenléti jelzőfénye kikapcsol, a készülék használatra kész.

## Tisztítás és karbantartás

1 Győződjön meg róla, hogy a készülék nincs csatlakoztatva.

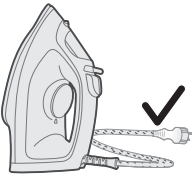
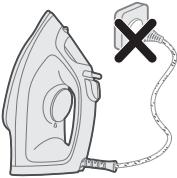

2 Győződjön meg róla, hogy a készülék lehűlt.

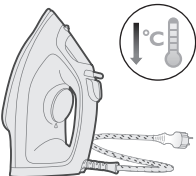



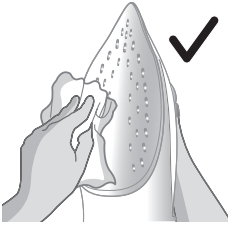

- 3** Nedves ruhával törölje le a vasalótalpról a vízkődarabkákat és egyéb lerakódásokat.



Megjegyzés: A vasalótalp épségének megóvása érdekében kerülje fémtárggyal való érintkezését. A vasalótalp tisztításához ne használjon súrolószivacsot, ecetet vagy egyéb vegyszereket.

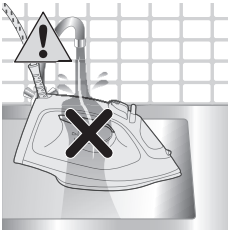

- 4** A keféket ne mossa/tisztítsa folyó víz alatt.

## Vízkőmentesítés

Tipp: A Quick Calc Release funkció bármikor használható. Ha kemény víz jellemezte területen él, használja gyakrabban a funkciót.



- 1** 1 hónap használat után ajánlott vízkőmentesítést végezni a készülékben felhalmozódott vízkőlerakódások eltávolításához a készülék élettartamának meghosszabbítása, illetve a készülék felmelegedésének biztosítása érdekében.

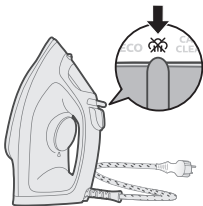

2 Ügyeljen rá, hogy a vasaló hálózati csatlakozódugója ki legyen húzva a fali aljzathoz, és a gőzbeállítás a „nincs gőz” (szár) helyzetbe legyen állítva .

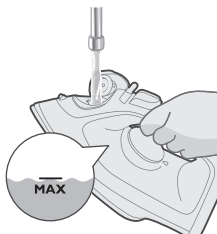

3 Töltse fel a víztartályt a MAX jelzésig.

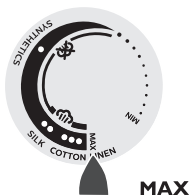

4 Állítsa a hőfokszabályozót MAX értékre.

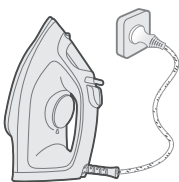

5 Csatlakoztassa a készüléket földelt fali aljzathoz.

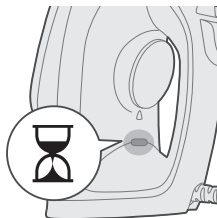

6 A készülék készenléti jelzőfénye világítani kezd, jelezve, hogy a vasaló melegszik.

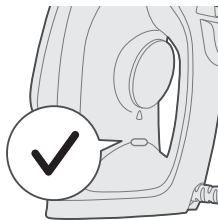

7 Várja meg, amíg a vasaló készenléti jelzőfénye kialszik.

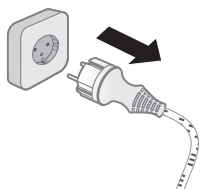

8 Húzza ki a vasaló hálózati dugóját a fali aljzatból.

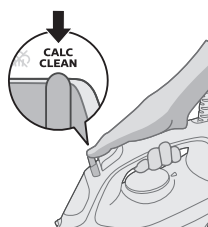

9 Csúsztassa a gőzválasztót vízkömentesítés állásba, és tartsa lenyomva.



10 Tartsa a vasalót a mosogató fölé, és óvatosan rázza meg a vasalót. A vasalótálpból forró víz és vízkőrészecskék fognak távozni.

Figyelem! A vízkővel együtt gőz és forrásban lévő víz is távozik a vasalótálpból.

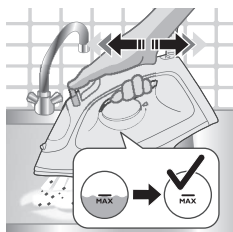

11 Rázza továbbra is a vasalót, amíg a tartályban található összes víz nem távozik.

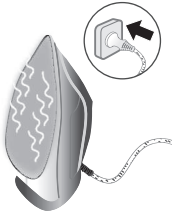

12 Csatlakoztassa a készüléket a fali aljzatba, és hagyja felmelegedni, hogy a talp megszáradhasson. Ez körülbelül 2 percig tart.

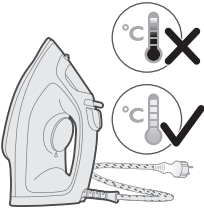

13 Hagyja lehűlni a vasalót.

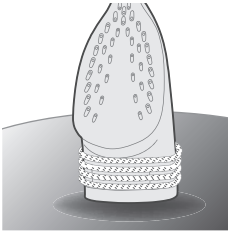

14 Tekerje a kábelt a vasaló sarka köré.

## Tárolás

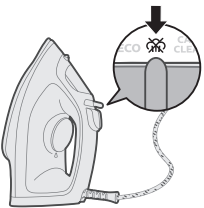

1 A gőzváltó segítségével válassza ki a „nincs gőz” (száraz vasalás) opciót ~~☒~~.

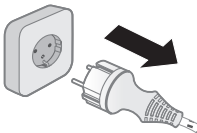

2 Húzza ki a készülék hálózati dugóját a fali aljzattól.

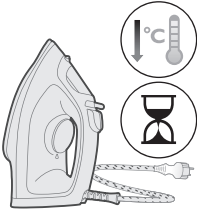

3 Hagyja lehűlni a készüléket.

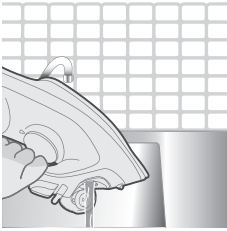

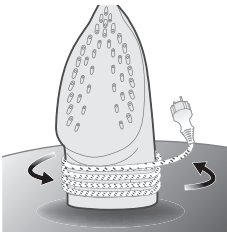

4 A maradék vizet öntse ki a víztartályból.



5 Tekerje a tápkábelt a fő készülékház köré.

## Hibaelhárítás

Ez a fejezet részletesen foglalkozik a készülékkel kapcsolatban leggyakrabban felmerülő problémákkal. Ha az alábbi útmutató segítségével nem tudja elhárítani a hibát, látogasson el a [www.philips.com/support](http://www.philips.com/support) weboldalra a gyakran ismétlődő kérdések listájáért, vagy forduljon az országában illetékes vevőszolgálathoz.

Probléma	Lehetséges ok	Megoldás
A vasaló nem távolítja el a gyűrődéseket a ruháról.	Nincs gőz vasalás közben.	Töltse fel a víztartályt, és állítsa a gőzbeállító csúszkát  fokozatra.
A vasaló nem termel gőzt.	Nincs elég víz a tartályban.	Töltse fel a víztartályt.
	A gőzbeállító csúszka a következő helyzetben van:  .	Állítsa a gőzbeállító csúszkát  állásba.

	A vasaló még nem elég forró a gőztermeléshez.	A vasaló melegezése közben a „vasaló kész” jelzőfény folyamatosan világít. Amikor a vasaló használatra kész, a jelzőfény kikapcsol.
Vízcseppek csöpögnek a ruhára vasalás közben.	Rövid idő alatt túl gyakran használta a lövet funkciót.	Folytassa a vasalást vízszintes helyzetben és várjon egy kicsit, mielőtt ismét használja a gőzlövet funkciót.
	Nem megfelelően zárta le a tartály fedelét.	Nyomja le a fedelet kattanásig.
A vasaló nem ad gőzlövetet.	A gőzlövet funkciót rövid idő alatt túl gyakran használta.	Folytassa a vasalást vízszintes helyzetben és várjon egy kicsit, mielőtt ismét használja a gőzlövet funkciót.
	A vasaló még nem elég forró a vasaláshoz.	Várja meg, amíg a „vasaló kész” jelzőfény már nem villog, hanem folyamatosan világít.
	Vegyszer került a víztartályba.	Öblítse ki a víztartályt, és ne tegyen bele semmiféle parfümöt vagy vegyszert.
A vasaló fali aljzatból való kihúzása után víz csepeg a vasalótálpból.	A gőzbeállító csúszka a következő helyzetben van:  .	Állítsa a gőzbeállító csúszkát  állásba.
	A vasaló vízszintes helyzetben van, és a víztartályban még maradt víz.	Használat után ürítse ki a víztartályt, vagy tárolja a vasalót függőleges helyzetben.
A vasalótól kifényesedik a ruha, vagy lenyomat kerül rá.	A vasalt felület egyenetlen volt, pl. mert varráson vagy hajtáson húzta keresztül a vasalót.	A vasaló minden vasalható ruhán biztonságosan használható. A ruha kifényesedése vagy a rajta keletkezett lenyomatok nem maradnak a ruhán, mosással eltávolíthatók. Ne vasalja át a varrásokot és hajtásokat. Ha ezekre a területekre pamut anyagot helyez, elkerülheti, hogy lenyomatok keletkezzenek.

# Introductie

Gefeliciteerd met uw aankoop en welkom bij Philips! Registreer uw product op [www.philips.com/welcome](http://www.philips.com/welcome) om optimaal gebruik te kunnen maken van de door Philips geboden ondersteuning. Lees deze gebruiksaanwijzing, het boekje met belangrijke informatie en de snelstartgids zorgvuldig door voor u het apparaat gebruikt. Bewaar ze om deze indien nodig later te kunnen raadplegen.

## Productoverzicht

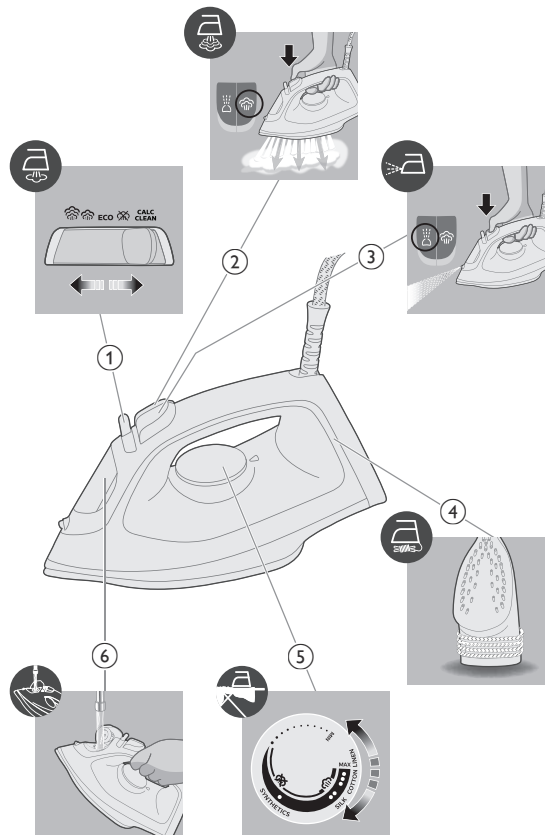

- 1 Stoomkeuzeknop
- 2 Stoomstootknop
- 3 Waterspray-functie
- 4 Oprolbaar koord
- 5 Temperatuurregelaar
- 6 Deksel van het waterreservoir

## Het apparaat gebruiken

### Klaarmaken voor gebruik

Opmerking: Er kan wat stoom uit het strijkijzer komen wanneer u het voor de eerste keer gebruikt. Dit zal vrij snel verdwijnen.

#### **Te gebruiken watersoort**

Het apparaat is geschikt voor gebruik met kraanwater. Als u echter in een gebied met hard water woont, raden wij u aan kraanwater te mengen met een gelijke hoeveelheid gedestilleerd of gedemineraliseerd water. Dit voorkomt snelle vorming van kalkaanslag en verlengt de levensduur van het apparaat.

**Voeg geen parfum, water uit de wasdroger, azijn, stijfsel, ontkalkingsmiddelen, strijkconcentraat, chemisch ontkalkt water of andere chemicaliën toe. Hierdoor kan het apparaat water gaan spetteren, bruine vlekken veroorzaken of beschadigd raken.**

### Het waterreservoir vullen

- 1 Sluit het apparaat niet aan op een stopcontact.

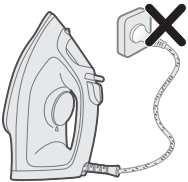

- 2 Zorg dat het apparaat is afgekoeld.

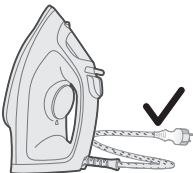



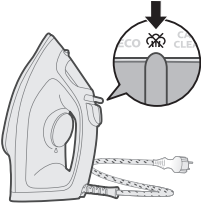

3 Schuif de stoomkeuzeknop naar rechts om de modus geen stoom (droog strijken) te selecteren .



4 Maak de deksel van het waterreservoir open.

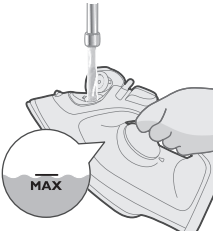

5 Vul het waterreservoir met water tot aan de MAX-aanduiding.

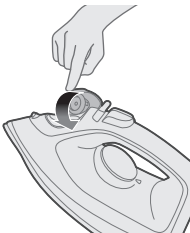

6 Sluit het deksel van het waterreservoir goed.

## Temperatuur instellen



MAX  
LINNEN



● ● ●  
KATOEN





● ●  
ZIJDE

**ECO**



●  
SYNTHETISCHE MATERIALEN



**ECO**



ECO-stand: Er wordt continu minimale constante stoom geleverd voor kledingstukken die minder kreuen. Deze instelling bespaart energie.



Twee stoomwolven: Er wordt constant meer stoom geleverd voor hardnekkige kreuen.



Drie stoomwolven: Er wordt continu maximale constante stoom geleverd voor hardnekkige kreuen.

## Het apparaat gebruiken

- 1 Kijk op het kledinglabel voor de vereiste strijkwijze.

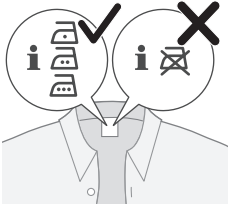

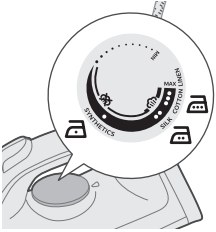

- 2 Stel de temperatuurknop in op de gewenste strijktemperatuur door hem naar de juiste temperatuuraanduiding te draaien.

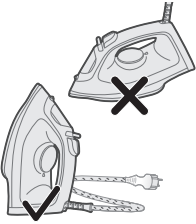

- 3 Laat het strijkijzer op de achterkant staan.

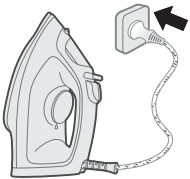

- 4 Sluit het apparaat aan op een geaard stopcontact.

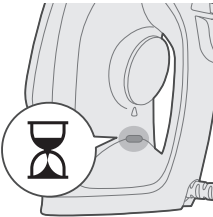

- 5 Het 'strijkijzer gereed'-lampje gaat branden om aan te geven dat het strijkijzer wordt opgewarmd.

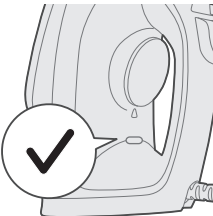

- 6 Als het 'strijkijzer gereed'-lampje niet meer brandt, wacht dan even voordat u begint met strijken. Het 'strijkijzer gereed'-lampje gaat af en toe branden tijdens het strijken.

## Geen stoom/droog strijken

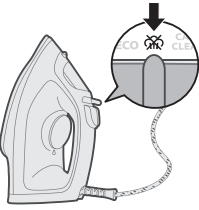

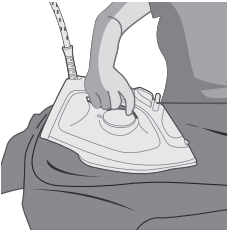

1 Stel de stoominstelling in op geen stoom.

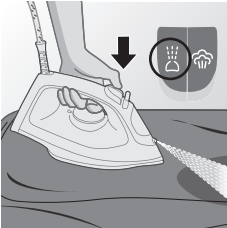

2 Na korte tijd komt er geen meer stoom tijdens het strijken.

## Waterspray-functie



1 Stel de stoominstelling in op geen stoom. Druk kort op de knop van de waterspray  voor een nevelstraal om hardnekkige kreuken te verwijderen.

## Extra stoomstoot

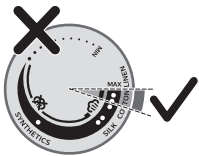

1 Zet de temperatuurregelaar op de MAX-stand tussen katoen en linnen.

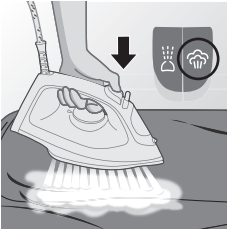

- 2 Druk op de stoomstootknop en laat deze weer los voor een krachtige stoomstoot waarmee u hardnekkige kreuken verwijdert.

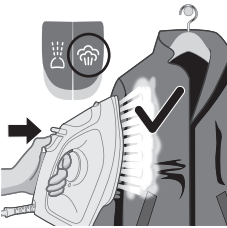

- 3 U kunt de stoomstootfunctie gebruiken als u het strijkijzer in verticale stand houdt om kreuken uit hangende kleding te verwijderen (alleen DST2020 en DST2030).

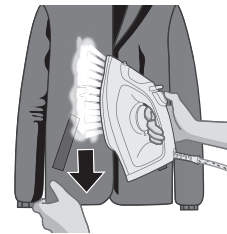

- 4 Trek en rek uw kledingstuk uit terwijl u een stoomstoot geeft om hardnekkige kreuken te verwijderen (alleen DST2020 en DST2030).



- 5 Gebruik uw blote hand niet als ondersteuning wanneer u stoomt.



- 6 Plaats het apparaat niet in de richting van uzelf of iemand anders.

## Automatische uitschakeling (DST2030)

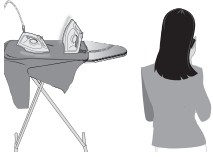

1 U kunt het apparaat met een gerust hart enige tijd laten staan zonder het te gebruiken. Het apparaat gaat dan vanzelf afkoelen.

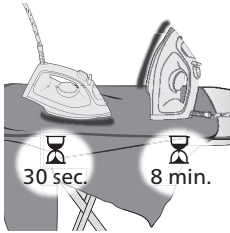

2 Wanneer het apparaat niet langer dan 30 seconden op de zoolplaat of 8 minuten op de hiel/voet rust, schakelt het automatisch uit.

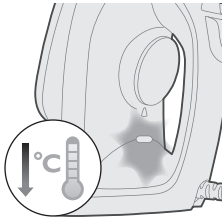

3 De temperatuur van het apparaat zal dalen in de automatische uitschakelmodus. Het 'strijkijzer gereed'-lampje knippert ook non-stop om aan te geven dat het apparaat automatisch wordt uitgeschakeld. Haal de stekker uit het stopcontact om het apparaat helemaal uit te zetten.

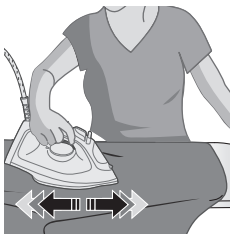

4 Om het apparaat weer op te warmen, pakt u het apparaat op of beweegt u het een beetje.

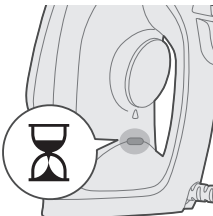

5 Het 'strijkijzer gereed'-lampje gaat branden om aan te geven dat het apparaat wordt opgewarmd.

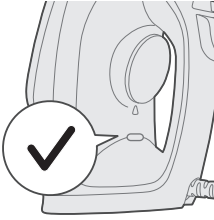

6 Als het 'strijkijzer gereed'-lampje uit is, is het apparaat klaar voor gebruik.

## Schoonmaken en onderhoud

1 Zorg dat de stekker van het apparaat niet in het stopcontact zit.

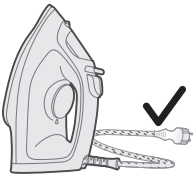
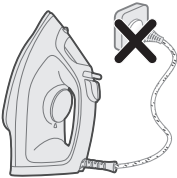

2 Zorg dat het apparaat is afgekoeld.

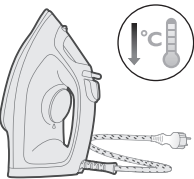

3 Veeg schilfers en andere aanslag van de zoolplaat met een vochtige doek.





Opmerking: Vermijd contact met metalen voorwerpen om de zool glad te houden. Gebruik nooit een schuursponsje, azijn of andere chemicaliën om de zoolplaat schoon te maken.

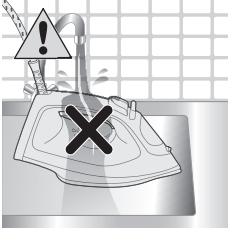

4 Was/maak de de borstel niet onder de kraan.

## Calc-Clean



Tip: U kunt de Quick Calc Release-functie altijd gebruiken. Als u in een gebied met hard water woont, gebruik de functie dan vaker.

1 Na 1 maand gebruik is het aan te raden om een Calc Clean uit te voeren om de verzamelde kalkaanslag van uw apparaat te verwijderen om de levensduur te verlengen en ervoor te zorgen dat het apparaat opwarmt.

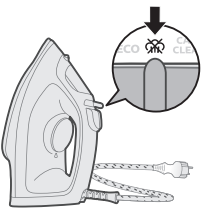

2 Zorg ervoor dat de stekker van het strijkijzer uit het stopcontact is en dat de stoomstand is ingesteld op de modus geen stoom (droog strijken) .



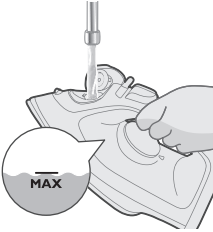

3 Vul het waterreservoir met water tot aan de MAX-aanduiding.



4 Zet de temperatuurregelaar op MAX.

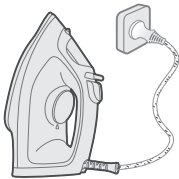

5 Sluit het apparaat aan op een geaard stopcontact.

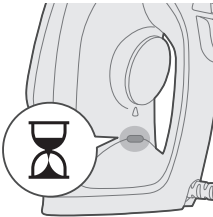

6 Het 'strijkijzer gereed'-lampje gaat branden om aan te geven dat het apparaat wordt opgewarmd.

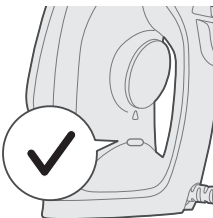

7 Wacht tot het 'strijkijzer gereed'-lampje uit is.

8 Haal de stekker van het strijkijzer uit het stopcontact.

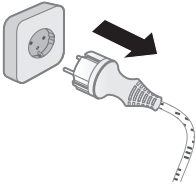

9 Zet de stoomkeuzeknop in de Calc-Clean-stand en houd hem vast.

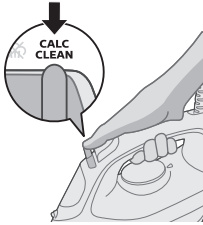

10 Houd het strijkijzer boven de gootsteen en schud het voorzichtig. Er komen heet water en kalkdeeltjes uit de zoolplaat.

Let op: Terwijl de kalkaanslag wordt weggespoeld, komen er ook stoom en kokend water uit de zoolplaat.



11 Blijf het strijkijzer schudden tot het waterreservoir helemaal leeg is.

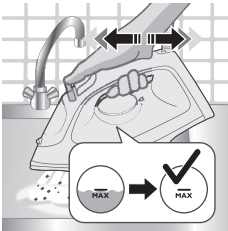

12 Steek de stekker in het stopcontact en laat het apparaat opwarmen om de zoolplaat te drogen. Dit duurt ongeveer 2 minuten.



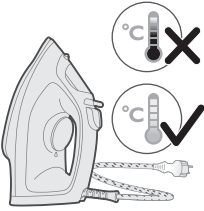

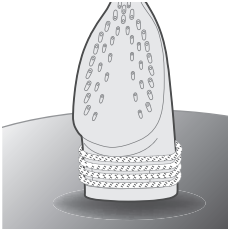

13 Laat het strijkijzer afkoelen.

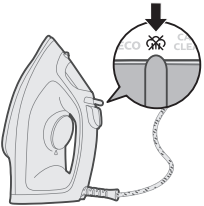

14 Wikkel het netsnoer rond de hiel van het strijkijzer.

## Opbergen



1 Schuif de stoomkeuzeknop om de modus geen stoom (droog strijken) te selecteren .

2 Haal de stekker uit het stopcontact.

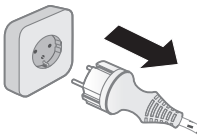

3 Laat het apparaat afkoelen.

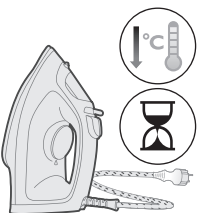

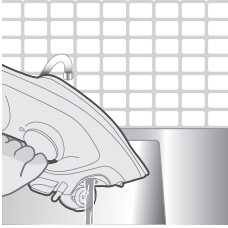

4 Giet overtollig water uit het waterreservoir.

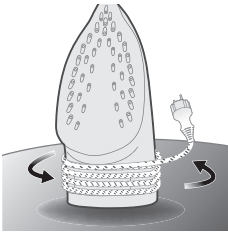

5 Wikkel het netsnoer rond de behuizing van het apparaat.

## Problemen oplossen

Dit hoofdstuk behandelt in het kort de problemen die u kunt tegenkomen tijdens het gebruik van uw apparaat. Als u het probleem niet met de onderstaande informatie kunt oplossen, gaat u naar [www.philips.com/support](http://www.philips.com/support) voor een lijst met veelgestelde vragen of neemt u contact op met het Consumer Care Centre in uw land.

Probleem	Mogelijke oorzaak	Oplossing
Het strijkijzer verwijdert geen kreuken uit het kledingstuk.	Er komt geen stoom vrij tijdens het strijken.	Vul het waterreservoir en zet de stoomkeuzeknop op  .
Het strijkijzer produceert geen stoom.	Er zit niet genoeg water in het waterreservoir.	Vul het waterreservoir.
	De stoomkeuzeknop staat op  .	Zet de stoomkeuzeknop op  .
	Het strijkijzer is nog niet warm genoeg om stoom te produceren.	Het 'strijkijzer gereed'-lampje brandt wanneer het strijkijzer aan het opwarmen is. Wanneer het strijkijzer klaar is voor gebruik, gaat het lampje uit.
Er druppelt water op het kledingstuk tijdens het strijken.	U hebt de stoomstootfunctie te vaak in korte tijd gebruikt.	Ga verder met horizontaal strijken en wacht even voordat u de stoomstootfunctie weer gebruikt.
	U hebt het waterreservoir niet goed gesloten.	Druk op het klepje tot u een klik hoort.

Het strijkijzer produceert geen stoomstoot.	U hebt de stoomstootfunctie te vaak in korte tijd gebruikt.	Ga verder met horizontaal strijken en wacht even voordat u de stoomstootfunctie weer gebruikt.
	Het strijkijzer is nog niet heet genoeg om te strijken.	Wacht tot het 'strijkijzer gereed'-lampje stopt met knipperen en blijft branden.
	U hebt een chemisch product in het waterreservoir gedaan.	Spoel het waterreservoir uit en doe geen parfum of chemische producten in het waterreservoir.
Er druppelt water uit de zoolplaat nadat u de stekker van het strijkijzer uit het stopcontact hebt gehaald.	De stoomkeuzeknop staat op  .	Zet de stoomkeuzeknop op  .
	U hebt het strijkijzer horizontaal neergezet terwijl er nog water in het waterreservoir zat.	Leeg het waterreservoir na elk gebruik of zet het strijkijzer verticaal neer.
Het strijkijzer laat een glans of een afdruk op het kledingstuk na.	Het oppervlak dat gestreken moest worden, was ongelijk, bijvoorbeeld omdat u over een naad of een vouw in het kledingstuk hebt gestreken.	Het strijkijzer is veilig te gebruiken op alle strijkbare kledingstukken. De glans of afdruk is niet blijvend en verdwijnt zodra u het kledingstuk wast. Voorkom dat u over een naad of vouw strijkt. U kunt ook een katoenen doek over het deel dat u wilt strijken leggen om afdrukken te voorkomen.

# Innledning

Gratulerer med kjøpet, og velkommen til Philips! Hvis du vil dra full nytte av brukerstøtten som Philips tilbyr, kan du registrere produktet ditt på [www.philips.com/welcome](http://www.philips.com/welcome). Les denne brukerhåndboken, det viktige informasjonsheftet og hurtigstartveiledningen nøye før du bruker apparatet. Ta vare på disse for fremtidig bruk.

## Produktoversikt

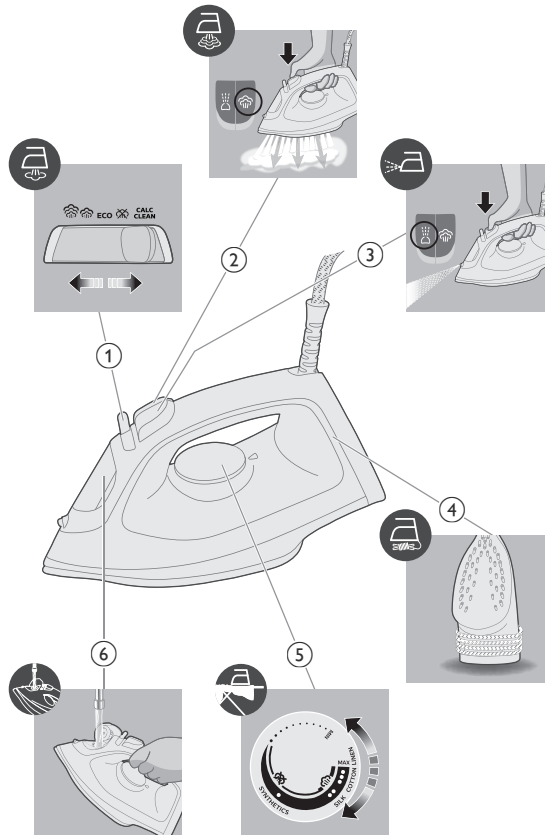

- 1 Dampvalg
- 2 Dampstøt knapp
- 3 Vanntåke
- 4 Ledningsvikling
- 5 Temperaturbryter
- 6 Lokk til vannbeholder

## Bruke apparatet

### Bruksforberedelse

Merk: Strykejernet kan avgi litt damp når du bruker det for første gang. Dette slutter etter en liten stund.

#### Vanntypen som skal brukes

Dette apparatet er egnet for bruk med springvann. Hvis du bor i et område med hardt vann, anbefaler vi at du blander en like stor mengde springvann med destillert eller demineralisert vann. Dette hindrer en rask dannelse av kalkavleiringer, mens apparatet får forlenget levetiden sin.

**Ikke legg til parfyme, vann fra tørketrommelen, eddik, stivelse, avkalkingsmidler, strykemidler, kjemisk avkalket vann eller andre kjemikalier, siden dette kan føre til vannsprut, brune flekker eller skade på apparatet**

### Oppfylling av vannbeholderen

- 1 Ikke koble til apparatet.

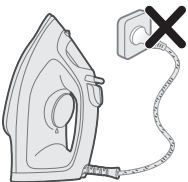

- 2 Forsikre deg om at apparatet er avkjølt.

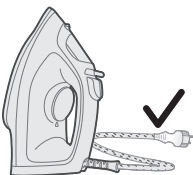

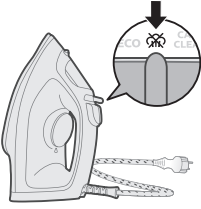

3 Skyv dampvalget til høyre for å velge modus uten damp (tørrstryking) .

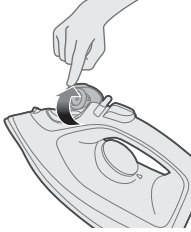

4 Vend opp lokket til vannbeholderen.

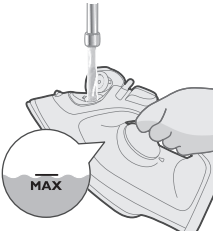

5 Fyll vannbeholderen opp til MAX-merket.



6 Lukk lokket til vannbeholderen godt.

## Innstilling av temperatur



MAX  
LIN



● ● ●  
BOMULL





● ●  
SILKE

ECO

●  
SYNTEISKE STOFFER

ECO



ECO-innstilling: Minimum konstant damp tilføres kontinuerlig for plagg med lite skrukker. Denne innstillingen sparer også energi.



To dampskyer: Mer konstant damp tilføres kontinuerlig for plagg med mye skrukker.

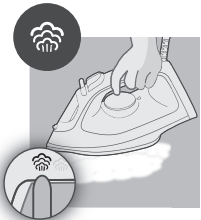

Tre dampskyer: Maksimum konstant damp tilføres kontinuerlig for plagg med vanskelige skrukker.

## Bruke apparatet

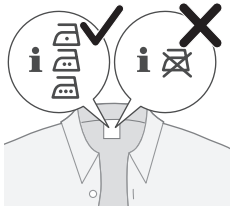

- 1 Sjekk merkingen på plagget for nødvendig stryking.

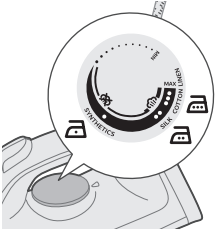

2 Still temperaturbryteren til ønsket stryketemperatur ved å dreie den til riktig temperaturindikasjon.

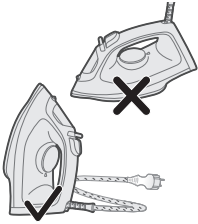

3 La strykejernet hvile på bakstykket.

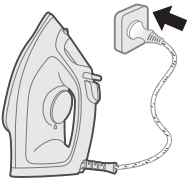

4 Koble til apparatet i en jordet veggkontakt.

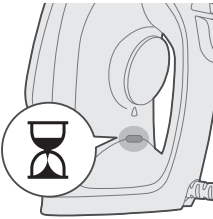

5 Lampen som indikerer at strykejernet er klart, lyser opp for å indikere at strykejernet varmes opp.

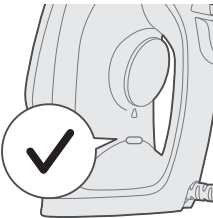

6 Når lampen slukker, venter du en liten stund før du begynner å stryke. Lampen lyser opp iblant under stryking.

## Ingen damp/tørstryking

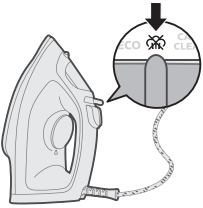

- 1 Still inn dampinnstillingen til ingen damp.

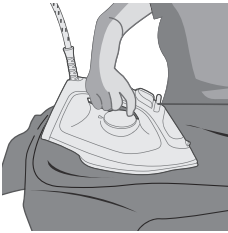

- 2 Etter en liten stund stopper dampen mens du stryker.

## Vanntåke

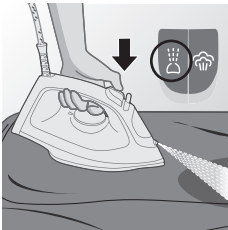

- 1 Still inn dampinnstillingen til ingen damp. Trykk på og slipp vanntåkeknappen  for å slippe ut en tåkedusj for å fjerne vanskelige skrukker.

## Dampstøt

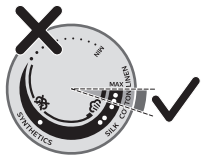

- 1 Still inn temperaturbryteren til MAX-innstillingen mellom bomull og lin.

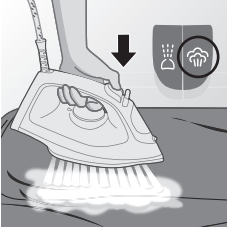

2 Trykk på og slipp dampstøtknappen for å slippe ut et kraftig støt med damp for å fjerne vanskelige skrukker.

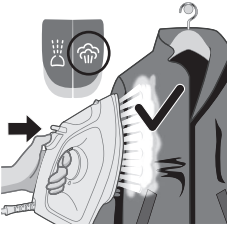

3 Du kan bruke dampstøtfunksjonen når du holder strykejernet loddrett for å fjerne skrukker fra opphengte plagg (kun for DST2020 og DST2030).

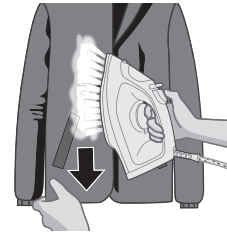

4 Dra og strekk i plagget mens du påfører dampstøt for å fjerne vanskelige skrukker (kun for DST2020 og DST2030).



5 Ikke bruk bare hender som underlag for plagget mens du stryker.



6 Ikke rett apparatet mot deg selv eller en annen person.

## Slår seg automatisk av (DST2030)

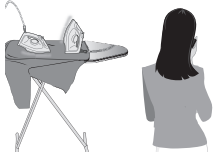

- 1 Apparatet er i stand til å kjøle ned av seg selv hvis det blir stående uten tilsyn i en periode, slik at du slipper å bekymre deg.

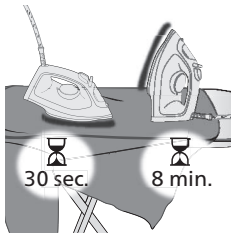

- 2 Når apparatet ikke brukes på over 30 sekunder mens det står på strykeplaten, eller 8 minutter mens det står på bakstykket eller i basen, vil apparatet gå inn i modus for automatisk avslåing.

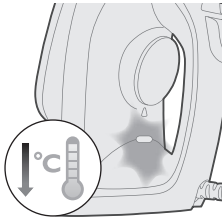

- 3 Apparatets temperatur synker mens det er i modus for automatisk avslåing. Lampen som indikerer at strykejernet er klart, vil også blinke kontinuerlig for å indikere at apparatet er automatisk slått av. Hvis du vil slå av apparatet helt, kobler du apparatet fra kontakten.

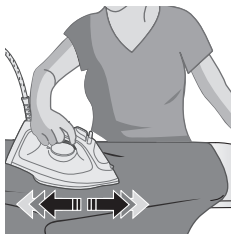

- 4 Hvis du vil la apparatet varme seg opp igjen, plukker du det opp eller flytter litt på det.

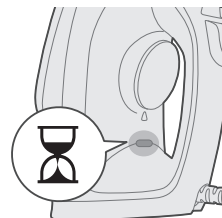

- 5 Lampen som indikerer at strykejernet er klart, lyser opp for å indikere at apparatet varmes opp.

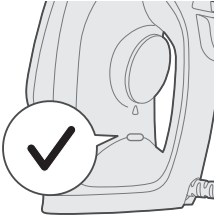

6 Når lampen som indikerer at strykejernet er klart, slutter å lyse, er apparatet klart til bruk.

## Rengjøring og vedlikehold

1 Forsikre deg om at apparatet ikke er koblet til.

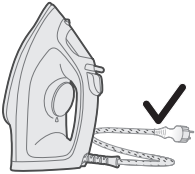
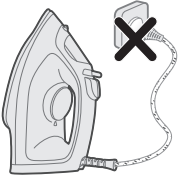

2 Forsikre deg om at apparatet har kjølt seg ned.

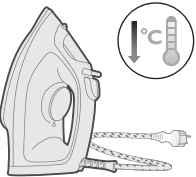

3 Tørk bort flak og andre avleiringer fra strykesålen med en fuktet klut.





Merk: Sørg for at strykesålen holdes jevn ved å unngå hard kontakt med metallgjenstander. Aldri bruk en skurebørste, eddik eller andre kjemikalier til å rengjøre strykesålen.

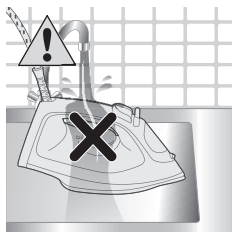

4 Ikke vask/rengjør apparatet under rennende vann.

## Kalkrensfunksjon

Tips: Funksjonen for rask kalkfjerning kan brukes når som helst. Hvis du bor i et område med hardt vann, bør du bruke funksjonen oftere.



1 Etter bruk i en måned anbefales det å bruke kalkrensfunksjonen for å fjerne kalkavleiringer fra apparatet. Dette forlenger levetiden og sikrer at apparatet varmes opp.

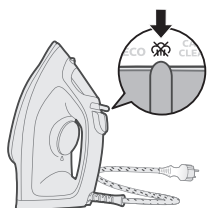

2 Forsikre deg om at strykejernet er koblet fra, og at dampinnstillingen er satt til modus uten damp (tørrstryking) .

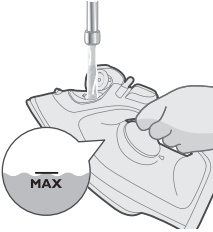

3 Fyll vannbeholderen til MAX-merket.



4 Still inn temperaturbryteren til MAX.

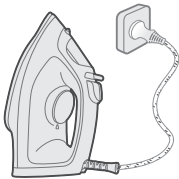

5 Koble til apparatet i en jordet veggkontakt.

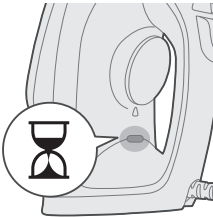

6 Lampen som indikerer at strykejernet er klart, lyser opp for å indikere at apparatet varmes opp.

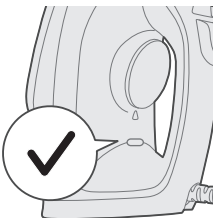

7 Vent til lyset på strykejernet slukker.



8 Koble fra strykejernet.

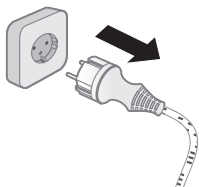

9 Skyv dampvelgeren til posisjonen for kalkrens, og hold den nede.

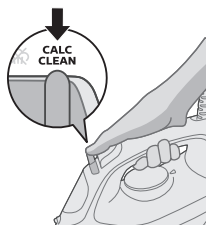

10 Hold strykejernet over vasken og rist det forsiktig. Varmt vann og kalkpartikler vil komme ut fra strykesålen.



Advarsel: Mens kalkavleiringene skylles ut, kommer det også damp og kokende vann ut av strykesålen.

11 Fortsett å riste strykejernet til alt vannet i vannbeholderen er brukt opp.

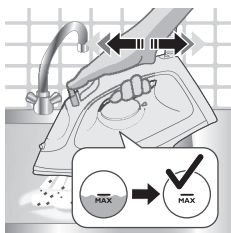

12 Koble til apparatet og la det varmes opp for å tørke strykesålen. Dette tar rundt to minutter.

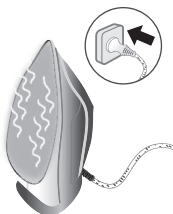

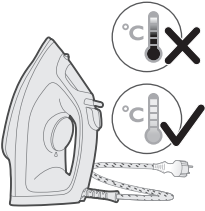

13 La strykejernet kjøle seg ned.

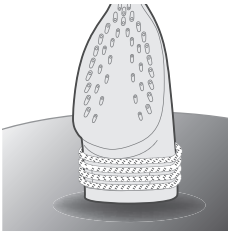

14 Kveil ledningen rundt bakstykket på strykejernet.

## Oppbevaring

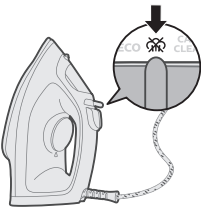

1 Skyv dampvalget for å velge modus uten damp (tørrstryking) .

2 Koble fra apparatet.

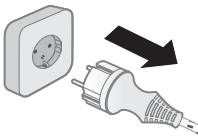

3 La apparatet kjøle seg ned.

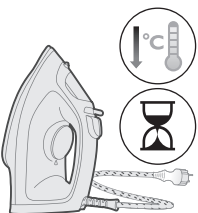

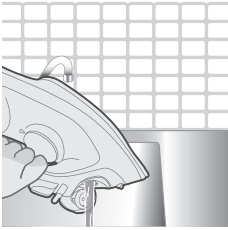

4 Hell ut vannet som er igjen i vanntanken.

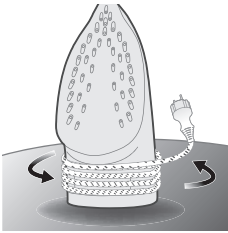



5 Kveil ledningen rundt hoveddelen på apparatet.

## Feilsøking

Dette kapitlet oppsummerer de vanligste problemene du kan oppleve med apparatet. Hvis du ikke kan løse problemet ved hjelp av informasjonen nedenfor, kan du gå til [www.philips.com/support](http://www.philips.com/support) for å se en liste over vanlige spørsmål, eller du kan kontakte forbrukerstøtten i landet der du bor.

Problem	Mulig årsak	Løsning
Strykejernet kan ikke fjerne skrukker fra plagget.	Det er ingen damp under strykingen.	Fyll vannbeholderen, og sett dampbryteren til  .
Strykejernet produserer ikke damp.	Det er ikke nok vann i beholderen.	Fyll vannbeholderen.
	Dampbryteren er satt til  .	Sett dampbryteren til  .
	Strykejernet er ikke varmt nok til å produsere damp.	Når strykejernet varmes opp, lyser lampen som indikerer at strykejernet er klart. Når strykejernet er klart til bruk, slukkes lampen.
Det drypper vanndråper på plagget under strykingen.	Du har brukt dampstøtfunksjonen for ofte i løpet av kort tid.	Fortsett å stryke i horisontal stilling, og vent litt før du bruker dampstøtfunksjonen igjen.
	Du har ikke lukket lokket på vannbeholderen ordentlig.	Trykk på lokket til du hører et klink.
Strykejernet avgir ikke dampstøt.	Du har brukt dampstøtfunksjonen for ofte i løpet av kort tid.	Fortsett å stryke i horisontal stilling, og vent litt før du bruker dampstøtfunksjonen igjen.

	Strykejernet er ikke varmt nok til å stryke ennå.	Vent til lampen som indikerer at strykejernet er klart, slutter å blinke og lyser kontinuerlig.
	Du har hatt kjemikalier i vannbeholderen.	Skyll vannbeholderen og ikke ha parfyme eller kjemikalier i vannbeholderen.
Det drypper vann fra strykesålen etter at strykejernet er koblet fra.	Dampbryteren er satt til  .	Sett dampbryteren til  .
	Du har satt strykejernet i horisontal stilling med vann igjen i vannbeholderen.	Tøm vannbeholderen etter bruk, eller oppbevar strykejernet i vertikal stilling.
Jernet etterlater seg et spor eller et avtrykk på plagget.	Flaten som ble strøket, var ujevn. Du kan for eksempel ha strøket over en søm eller en brett i plagget.	Strykejernet kan brukes på alle strykbare plagg. Glansen eller avtrykket er ikke permanent og forsvinner når du vasker plagget. Unngå å stryke over sømmer eller bretter. Du kan også legge en bomullsklut over området som skal strykes for å unngå avtrykk.

## Kirish

Xaridingiz muborak bo'lsin va Philips'ga xush kelibsiz! Philips taklif qiladigan qo'llab-quvvatlash xizmatidan foydalanish uchun jihozingizni [www.philips.com/welcome](http://www.philips.com/welcome) saytida ro'yxatdan o'tkazing. Qurilmani ishlatishdan oldin ushbu qo'llanmani, muhim ma'lumot risolasini va tez ishga tushirish bo'yicha ko'rsatmalarni diqqat bilan o'qib chiqing. Ularni kelgusida ma'lumot uchun saqlab qo'ying.

## Mahsulot sharxi

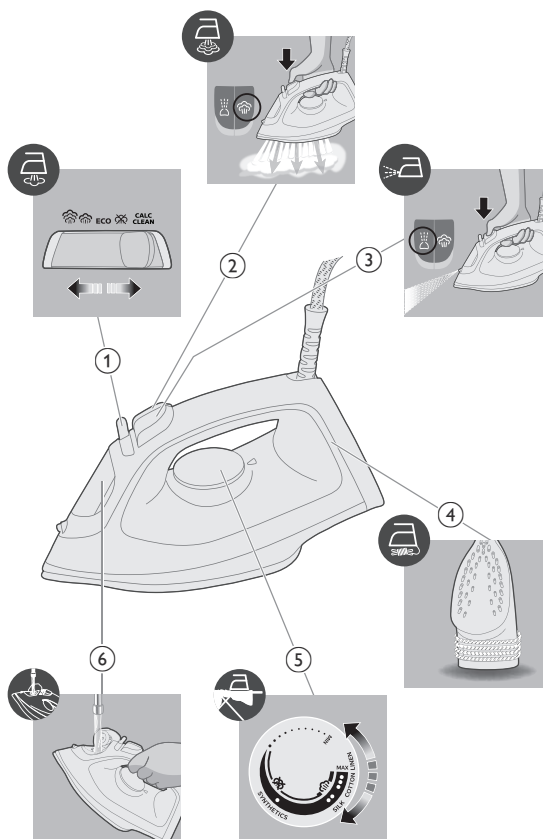

- 1 Bug' tanlagich
- 2 Bug'ni kuchaytirish tugmasi
- 3 Suv purkagich
- 4 Shnurni o'rash
- 5 Harorat shkalasi
- 6 Suv baki qopqog'i

## Jihozdan foydalanish

### Ishlatishga tayyorlash

Eslatma: Dazmolni birinchi marta ishlatsangiz, undan biroz bug' chiqishi mumkin. Bu biroz vaqtdan keyin yo'qoladi.

#### Ishlatiladigan suv turi

Jihozga vodoprovod suvini ham ishlatish mumkin. Biroq, agar siz suvi qattiq hududlarda yashasangiz, teng miqdordagi distillangan yoki demineralizatsiyalangan suv bilan aralashtirishni tavsiya qilamiz. Bu cho'kmaning tez to'planishining oldini oladi va jihozning xizmat muddatini oshiradi.

**Xushbo'y, quritish mashinasining suvi, sirka, kraxmal, cho'kmalarni tozalash vositalari, dazmol qilish vositalari, kimyoviy cho'kmalardan tozalangan suv yoki boshqa kimyoviy moddalarni quymang, chunki ular sizib chiqishi, jigarrang dog'lar hosil qilishi yoki jihazingizga shikast yetishiga sabab bo'lishi mumkin.**

### Suv bakini to'ldirish

- 1 Jihozni ulamang.

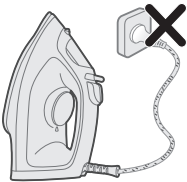

2 Jihoz sovganiga amin bo'ling.

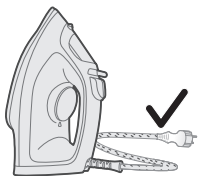

3 Bug'siz rejimini (quruq dazmollash) tanlash uchun bug' tanlagichni o'ngga suring ~~CHA~~.

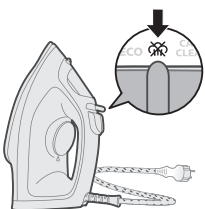

4 Suv baki qopqog'ini chertib oching.

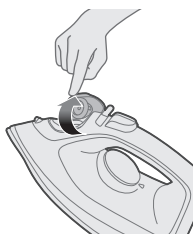

5 Suv bakini suv bakidagi MAX belgisigacha to'ldiring.

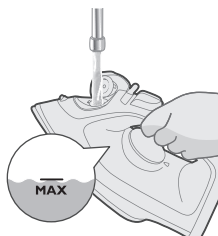

6 Suv baki qopqog'ini mahkam yoping.

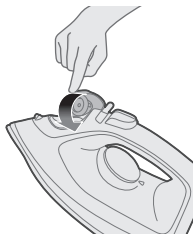

## Haroratni sozlash



	MAX ZIG'IRDAN TO'QILGAN MATO	
	● ● ● ● PAXTA	
	● ● IPAK	<b>ECO</b>
	● SINTETIKA	

ECO



ECO sozlamasi: Burmalari kamroq bo'lgan kiyimlar uchun minimal o'zgarmas bug' ajratiladi. Bu sozlama ham energiyani tejaydi.



Ikkita bug' buluti: Qattiq burmalar uchun yanada o'zgarmas bug' muntazam ta'minlab turiladi.



Ucha bug' buluti: Qattiq burmalar uchun maksimal o'zgarmas bug' muntazam ta'minlab turiladi.



## Jihozdan foydalanish

1 Qanday dazmollash kerakligini bilish uchun kiyim yorlig'ini tekshiring.

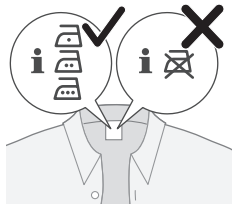

2 Harorat murvatini mos harorat belgisiga burash orqali uni kerakli dazmollash haroratiga o'rnatish.

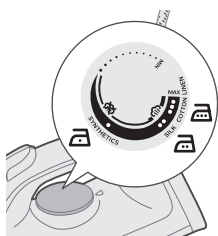

3 Dazmolni tayanchiga tushiring.

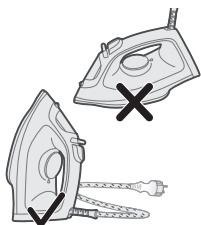

4 Jihozni yerga ulangan devor rozetkasiga ulang.

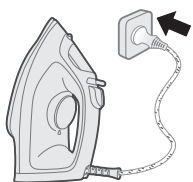

5 Dazmol tayyor chirog'i yongani dazmol qiziyotganligini anglatadi.

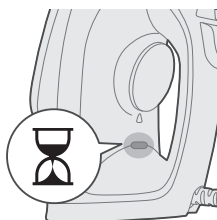

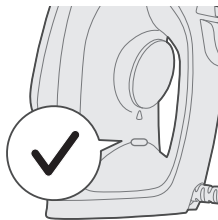

- 6 Dazmol tayyor chirog'i o'chganda dazmollashni boshlashdan oldin biroz kuting. Tayyor chirog'i dazmollayotganda vaqti-vaqti bilan o'chib-yonib turadi.

## Bug'siz/Quruq dazmollash

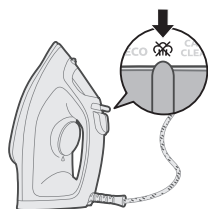

- 1 Bug' sozlamasini bug'siz sozlamasiga o'rnating.

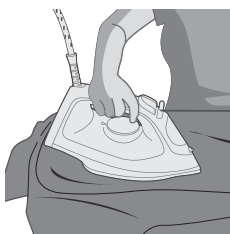

- 2 Ozgina vaqt o'tgach, dazmollash vaqtida bug' chiqishi yo'qoladi.

## Suv purkagich



- 1 Bug' sozlamasini bug'siz sozlamasiga o'rnating. Qattiq burmalarni ketkazish uchun, tuman oqimi hosil qiluvchi suv purkash tugmasini  bosib, qo'yib yuboring.

## Bug'li zarba

- 1 Haroratini murvatini paxta va zig'irdan to'qilgan mato o'rtasidagi MAX sozlamasiga o'rnatib.

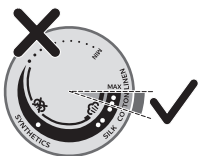

- 2 Qattiq burmalarni ketkazish uchun kuchli bug' chiqaradigan bug'ni kuchaytirish tugmasini bosib va qo'yib yuboring.



- 3 Osilib turgan kiyimlarning burmalarni ketkazish uchun dazmolni vertikal holatda ushlab turganingizda bug'ni kuchaytirish funksiyasidan foydalanishingiz mumkin (faqat DST2020 va DST2030 uchun).



- 4 Qattiq burmalarni ketkazish uchun bug' kuchaytirgich ishlatilayotgan paytda kiyimni torting va cho'zing (faqat DST2020 va DST2030 uchun).

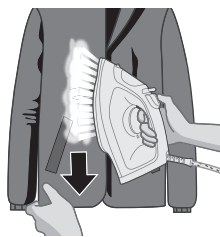

- 5 Dazmolayotgan paytda tirgak sohani ochiq qo'lingiz bilan ushlamang.



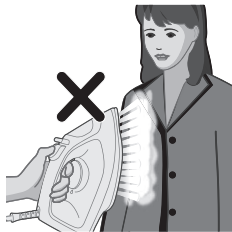

6 Jihozni o'zingiz/boshqa shaxsga qaratib joylashtirmang.

## Avtomatik o'chirish (DST2030)



1 Sizni bezovta qilmaslik uchun, jihaz biroz vaqt nazoratsiz qoldirilsa, u o'zi soviydi.

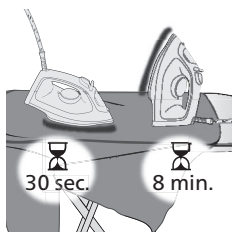

2 Jihaz tagligida 30 soniyadan ortiq yoki tayanch/asosida 8 daqiqa ishlatilmasa, u avtomatik o'chish rejimiga o'tadi.

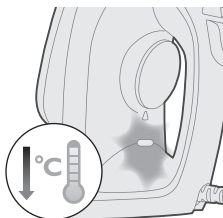

3 Jihaz harorati avtomatik o'chish rejimida pasayadi. Jihaz avtomatik o'chish holatidagini ko'rsatish uchun "dazmol tayyor" chirog'i ham tinimsiz miltillaydi. Jihazni to'liq o'chirish uchun uning vilkasini rozetkadan uzing.

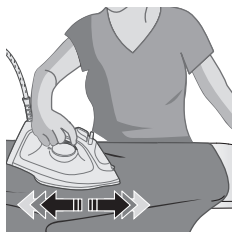

4 Jihaz qayta qizishiga imkon berish uchun jihazni ko'taring yoki biroz suring.

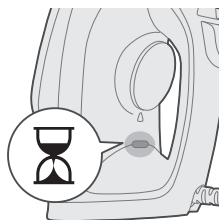

5 Dazmol tayyor chirog'i yongani jihoz qiziyotganligini anglatadi.

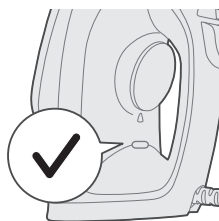

6 Dazmol tayyor chirog'i o'chganida jihoz foydalanishga tayyor bo'ladi.

## Tozalash va texnik xizmat ko'rsatish

1 Jihoz tarmoqqa ulanmaganiga amin bo'ling.

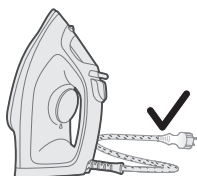
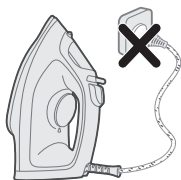

2 Jihoz soviganiga amin bo'ling.

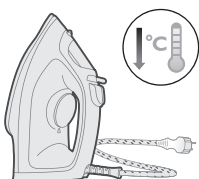

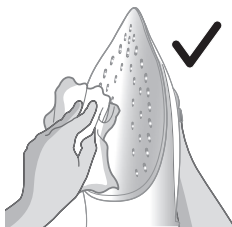

- 3 Dazmol plitasidagi parchalar va har qanday qoldiqlarni nam mato bilan artib tozalang.



Eslatma: Dazmol plitasi silliq bo'lishini ta'minlash uchun metall obyektlarga tekkizmang. Idish yuvish matosi, sirka yoki boshqa kimyoviy moddalardan dazmol plitasini tozalash uchun foydalanmang.

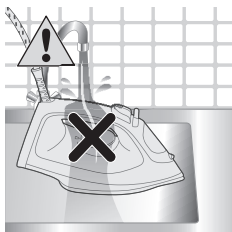

- 4 Jihozni vodoprovod suvi ostida yuvmang/tozalamang.

## Cho'kmadan tozalash

Maslahat: Cho'kmani tezkor tozalash funksiyasi istalgan vaqtda ishlatilishi mumkin. Suvi qattiq mintaqada yashasangiz, funksiyadan tez-tez foydalaning.



- 1 1 oy ishlatilganidan so'ng, jihozning xizmat ko'rsatish muddatini uzaytirish va uning qizishini ta'minlash uchun, unda to'plangan cho'kmalarni olib tashlash maqsadida jihozni cho'kmadan tozalash funksiyasini ishlatish tavsiya etiladi.

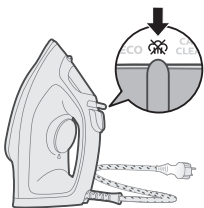

2 Dazmol tarmoqdan uzilgani va bug' sozlamasi bug'siz rejimiga (quruq dazmollash) qo'yilganiga amin bo'ling.

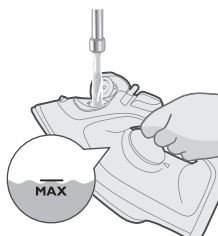

3 Suv bakini MAX belgisigacha to'ldiring.

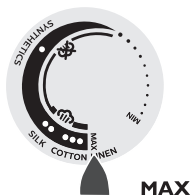

4 Harorat murvatini MAXga o'rninging.

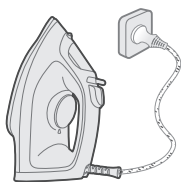

5 Jihozni faqat yerga ulangan devor rozetkasiga ulang.

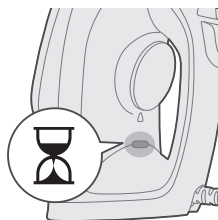

6 Dazmol tayyor chirog'i yongani jihaz qiziyotganligini anglatadi.

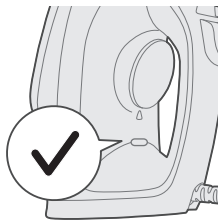

7 Dazmol tayyor chirog'i o'chishini kuting.

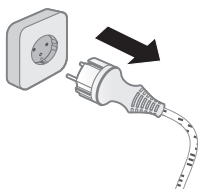

8 Dazmolni rozetkadan uzing.

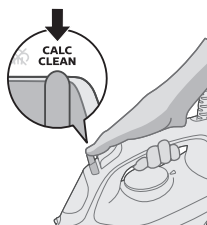

9 Bug' tanlagichni Cho'kmani tozalash holatiga qo'yib, ushlab turing.



10 Dazmolni rakovina ustida ushlang va ohista silkiting. Issiq suv va cho'kma zarralari plitadan chiqib ketadi.

Diqqat: Cho'kma chayilayotgan vaqtda, plitadan bug' va qaynoq suv ham chiqadi.

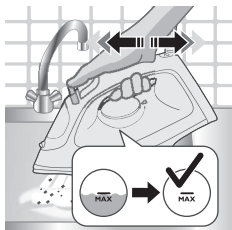

11 Suv bakidagi suv to'liq chiqib ketgunicha dazmolni silkitishda davom eting.



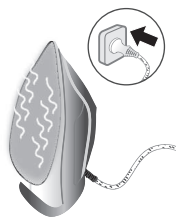

**12** Jihozni tarmoqdan izing va asos plita qurigunicha jihazni qizdiring. Bu taxminan 2 daqiqa vaqt oladi.

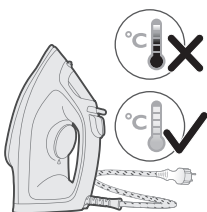

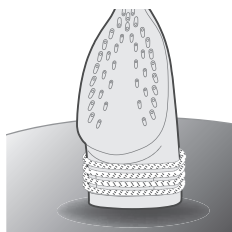

**13** Dazmol sovishini kuting.

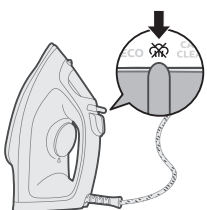

**14** Dazmolning tayanchi atrofiga shnurini o'rang.

## Saqlash



**1** Bug'siz rejimini (quruq dazmollash) tanlash uchun bug' tanlagichni suring 

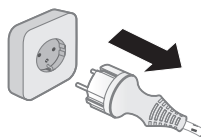

**2** Jihazni tarmoqdan izing.

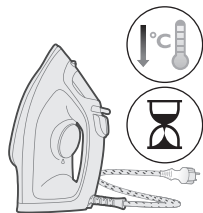

3 Jihoz sovishini kuting.

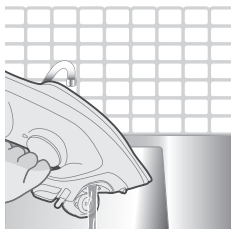

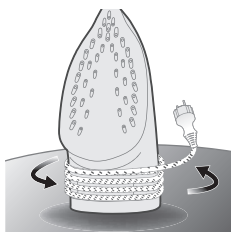

4 Suv bakidagi qolgan suvni to'kib tashlang.



5 Quvvat shnurini jihazning asosiy korpusi atrofiga o'rang.

## Nosozliklarni aniqlash

Bu bobda jihazda uchraydigan eng keng tarqalgan muammolar umumlashtirilgan. Agar quyidagi ma'lumotga asosanib muammoni hal qila olmasangiz, savol-javoblar ro'yxati uchun [www.philips.com/support/manziliga](http://www.philips.com/support/manziliga) kiring yoki mamlakatingizdagi mijozlarga xizmat ko'rsatish markazi bilan bog'laning.

Muammo	Ehtimoliy sabab	Yechim
Dazmol kiyimdagi burmalarni tekislay olmaydi.	Dazmollash vaqtida bug' chiqmaydi.	Suv bakini to'ldiring va bug' slayderini  holatiga qo'ying.
Dazmoldan bug' chiqmaydi.	Bakda yetarlicha suv yo'q.	Suv bakini to'ldiring.
	Bug' slayderi  holatiga qo'yilgan.	Bug' slayderini  holatiga qo'ying.
	Dazmol bug' chiqarish uchun yetarlicha qizimagan.	Dazmol qiziyotganda, "dazmol tayyor" chirog'i barqaror yoniq bo'ladi. Dazmol foydalanishga tayyor bo'lganda, chiroq o'chadi.

Dazmollash vaqtida kiyimga suv tomadi.	Kuchaytirish funksiyasidan qisqa vaqt ichida juda ko'p foydalangansiz.	Gorizontal holatda dazmollashni davom ettiring va bug'ni kuchaytirish funksiyasini qayta ishlatish uchun biroz kuting.
	Suv baki qopqog'ini yaxshi yopmagansiz.	"Tiq" etgan tovushni eshitguningizcha qopqoqni bosing.
Dazmol bug'ni kuchaytirmayapti.	Bug'ni kuchaytirish funksiyasidan qisqa vaqt ichida juda ko'p foydalangansiz.	Gorizontal holatda dazmollashni davom ettiring va bug'ni kuchaytirish funksiyasini qayta ishlatish uchun biroz kuting.
	Dazmol dazmollash uchun yetarlicha issiq emas.	"Dazmol tayyor" chirog'i miltillashni to'xtatishini va chiroqlar uzluksiz yonishini kuting.
	Suv bakiga kimyoviy modda quygansiz.	Suv bakini yuving va atir yoki kimyoviy moddalarni suv bakiga quymang.
Dazmol tarmoqdan uzilganidan keyin asos plitadan suv tomchilaydi.	Bug' slayderi  holatiga qo'yilgan.	Bug' slayderini  holatiga qo'ying.
	Suv bakidan suvni to'liq to'kmay, uni gorizontal holatda qoldirgansiz.	Ishlatishdan keyin suv bakini bo'shating yoki dazmolni vertikal holatda saqlang.
Dazmol kiyimda yaltirash yoki iz qoldiradi.	Dazmol qilinadigan yuza tekis bo'lmagan, masalan, siz kiyimni chok yoki burmaning ustida dazmollagansiz.	Dazmolni barcha dazmol qilinadigan kiyimlarda ishlatish xavfsiz. Yaltirash yoki iz doimiy emas va kiyim yuvilganida yo'qoladi. Chok yoki burmalarning ustida dazmollamang. Izlardan saqlanish uchun dazmol qilinadigan joyga paxta mato qo'yishingiz mumkin.

# Wstęp

Gratulujemy zakupu i witamy wśród klientów firmy Philips! Aby w pełni skorzystać z obsługi świadczonej przez firmę Philips, należy zarejestrować zakupiony produkt na stronie [www.philips.com/welcome](http://www.philips.com/welcome). Przed użyciem urządzenia zapoznaj się dokładnie z niniejszą instrukcją obsługi, ulotką informacyjną oraz skróconą instrukcją obsługi. Zachowaj te dokumenty na przyszłość.

## Opis produktu

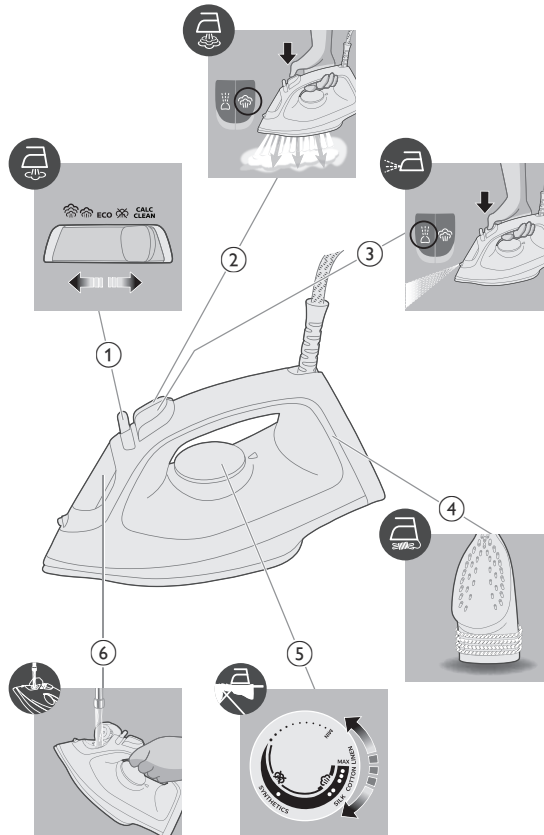

- 1 Wybór typu pary
- 2 Przycisk silnego uderzenia pary
- 3 Spryskiwanie wodą
- 4 Nawijanie przewodu
- 5 Pokrętło regulatora temperatury
- 6 Pokrywka zbiornika wody

## Zasady używania urządzenia

### Przygotowanie do użycia

Uwaga: podczas pierwszego użycia z żelazka może wydostawać się niewielka ilość pary. Zjawisko to ustanie po krótkiej chwili.

#### Rodzaj używanej wody

Urządzenie jest przystosowane do wody z kranu. Jeśli jednak mieszkasz w miejscu, w którym występuje twarda woda, zalecamy wymieszanie wody z kranu z taką samą ilością wody destylowanej lub demineralizowanej. Zapobiegnie to osadzaniu się kamienia i wydłuży żywotność urządzenia.

**Nie należy dodawać perfum, wody z suszarek bębnowych, octu, krochmalu, środków do usuwania kamienia lub ułatwiających prasowanie, wody odwapnionej chemicznie ani żadnych innych środków chemicznych, gdyż może to spowodować wyciek wody, powstawanie brązowych plam lub uszkodzenie urządzenia.**

### Napełnianie zbiornika wody

- 1 Nie podłączaj urządzenia.

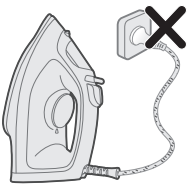

2 Upewnij się, że urządzenie ostygło.

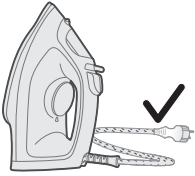

3 Przesuń przełącznik pary w prawo, aby wybrać tryb bez pary (prasowanie na sucho) ~~ON~~.

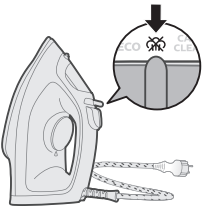

4 Otwórz pokrywę zbiornika wody.



5 Napełnij zbiornik wodą do poziomu oznaczonego symbolem „MAX” na zbiorniku.

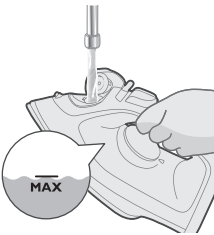

6 Dokładnie zamknij pokrywkę zbiornika wody.

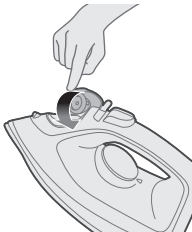

## Ustawianie temperatury



	MAX LEN	
	● ● ● BAWEŁNA	
	● ● JEDWAB	<b>ECO</b>
	● TKANINA SYNTETYCZNA	

ECO



Ustawienia ECO: Minimalny stały strumień pary jest uwalniany w sposób ciągły w przypadku ubrań z mniejszą ilością zagnieceń. To ustawienie oszczędza również energię.



Dwie chmury pary: Większa ilość pary jest uwalniana w sposób ciągły w przypadku dużych zagnieceń.



Trzy chmury pary: Maksymalna ilość pary jest uwalniana w sposób ciągły w przypadku uporczywych zagnieceń.

## Zasady używania urządzenia

- 1 Sprawdź metkę odzieży, aby znaleźć informacje dotyczące prasowania.

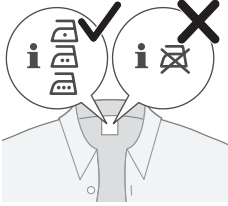

- 2 Ustaw pokrętko regulatora temperatury na wymaganą temperaturę prasowania, obracając je do odpowiedniego wskaźnika temperatury.

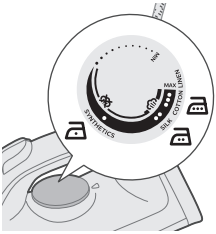

- 3 Pozostaw żelazko w pozycji pionowej.

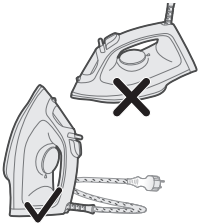

- 4 Podłącz urządzenie do uziemionego gniazdka elektrycznego.

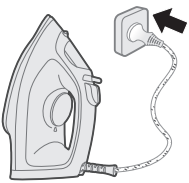

- 5 Wskaźnik gotowości do prasowania zaświeci się, wskazując, że żelazko się nagrzewa.

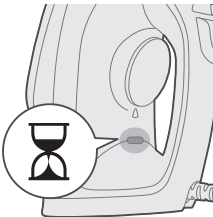



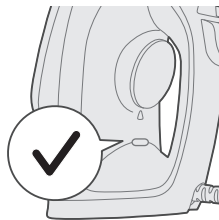

- 6 Gdy wskaźnik gotowości do prasowania zgaśnie, odczekaj chwilę przed rozpoczęciem prasowania. Wskaźnik gotowości będzie się od czasu do czasu zapalać podczas prasowania.

## Brak pary / prasowanie na sucho

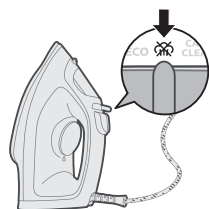

- 1 Wybierz ustawienie braku pary.

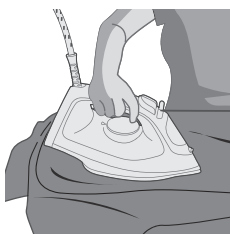

- 2 Po krótkiej chwili para nie będzie już uwalniana podczas prasowania.

## Spryskiwanie wodą



- 1 Wybierz ustawienie braku pary. Naciśnij i zwolnij przycisk spryskiwania wodą , aby uwolnić strumień mgiełki do usuwania uporczywych zagnieceń.

## Silne uderzenie pary

- 1 Ustaw pokrętko regulatora temperatury na MAX pomiędzy ustawieniem bawełny i lnu.

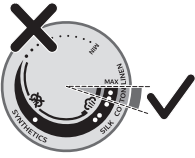

- 2 Naciśnij i zwolnij przycisk silnego uderzenia pary, aby uzyskać uderzenie pary umożliwiające usunięcie uporczywych zagnieceń.



- 3 Funkcji silnego uderzenia pary można użyć, trzymając żelazko w pozycji pionowej, aby usunąć zagniecenia z wiszących ubrań (dotyczy tylko DST2020 i DST2030).

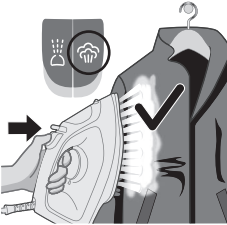

- 4 Aby usunąć uporczywe zagniecenia, należy pociągnąć i rozciągnąć ubranie podczas używania funkcji silnego uderzenia pary (dotyczy tylko DST2020 i DST2030).

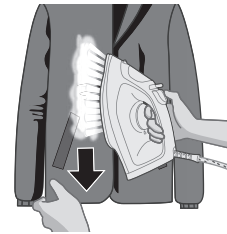

- 5 Nie opieraj się niezabezpieczoną ręką podczas prasowania parowego.



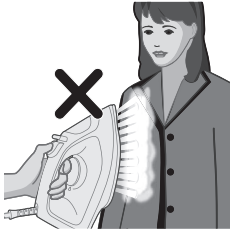

- 6 Nie ustawiaj urządzenia w kierunku swoim lub innej osoby.

## Automatyczne wyłączenie (DST2030)

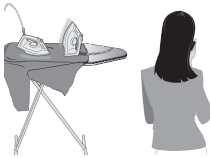

- 1 Ze względów bezpieczeństwa urządzenie samo się schładza, gdy zostanie pozostawione bez nadzoru przez określony czas.

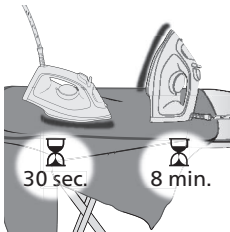

- 2 Jeśli urządzenie nie jest używane przez ponad 30 sekund w pozycji leżącej na stopie żelazka lub przez 8 minut w pozycji pionowej, przejdzie w tryb automatycznego wyłączenia.

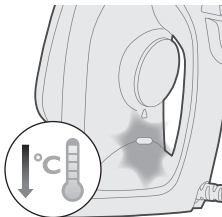

- 3 Temperatura urządzenia obniży się w trybie automatycznego wyłączenia. Wskaźnik gotowości do prasowania będzie również stale migać, wskazując, że urządzenie znajduje się w stanie automatycznego wyłączenia. Aby całkowicie wyłączyć urządzenie, odłącz je od gniazdka zasilania.

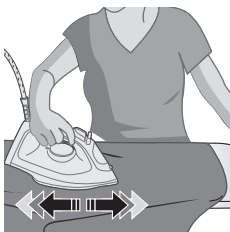

- 4 Aby urządzenie ponownie się nagrzało, podnieś je lub lekko przesunij.

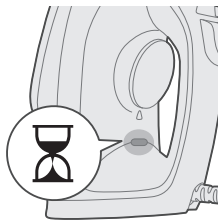

5 Wskaźnik gotowości do prasowania zaświeci się, wskazując, że urządzenie się nagrzewa.

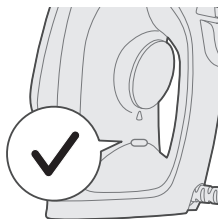

6 Gdy wskaźnik gotowości do prasowania zgaśnie, urządzenie jest gotowe do użycia.

## Czyszczenie i konserwacja

1 Upewnij się, że urządzenie nie jest podłączone do zasilania.

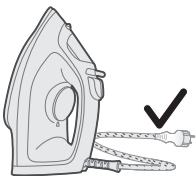
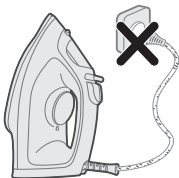

2 Upewnij się, że urządzenie ostygło.

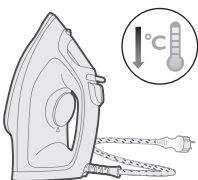



3 Wytrzyj osad ze stopy wilgotną ściereczką.



Uwaga: aby stopa żelazka była gładka, należy unikać kontaktu z metalowymi przedmiotami. Nigdy nie używaj ostrych ściereczek, octu ani innych środków chemicznych do czyszczenia stopy żelazka.

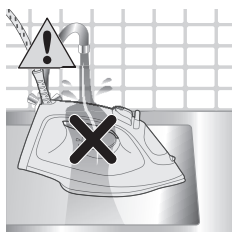

4 Nie myj/wycieraj urządzenia pod bieżącą wodą.

## Calc-Clean

Wskazówka: funkcji Quick Calc Release można użyć w dowolnym momencie. Jeśli mieszkasz miejscu, w którym występuje twarda woda, używaj tej funkcji częściej.



1 Po miesiącu użytkowania zaleca się przeprowadzenie czyszczenia Calc-Clean w celu usunięcia kamienia nagromadzonego w urządzeniu, aby przedłużyć jego żywotność i zdolność do nagrzewania się.

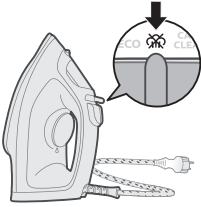

2 Upewnij się, że żelazko jest odłączone od zasilania, a ustawienie pary jest ustawione na tryb bez pary (prasowanie na sucho) .

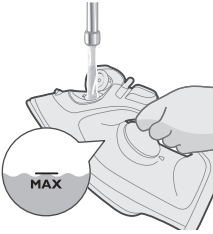

3 Napełnij zbiornik wodą do poziomu oznaczonego symbolem „MAX”.



4 Ustaw pokrętko regulatora temperatury w pozycji „MAX”.

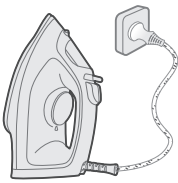

5 Podłącz urządzenie do uziemionego gniazdka elektrycznego.

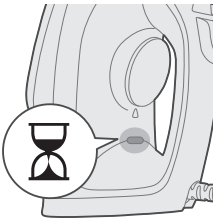

6 Wskaźnik gotowości do prasowania zaświeci się, wskazując, że urządzenie się nagrzewa.

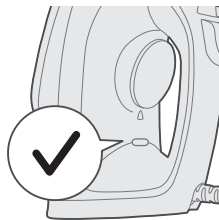

7 Poczekaj, aż wskaźnik gotowości do prasowania zgaśnie.

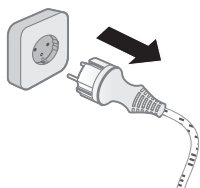

8 Odłącz żelazko.

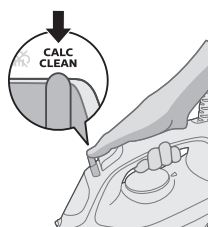

9 Przesuń przełącznik pary do pozycji Calc-Clean i przytrzymaj go.



10 Przytrzymaj żelazko nad zlewem i delikatnie nim potrząśnij. Ze stopy żelazka zacznie wydobywać się gorąca woda i cząsteczki kamienia.

Uwaga: podczas wypłukiwania kamienia ze stopy żelazka wydobywa się para i gorąca woda.

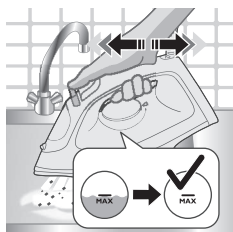

11 Kontynuuj potrząsanie żelazkiem, aż ze zbiornika wyleci cała woda.

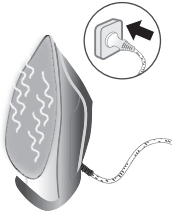

**12** Podłącz urządzenie do gniazdka i pozwól mu się nagrzać, aby wysuszyć stopę żelazka. Zajmuje to około 2 minut.

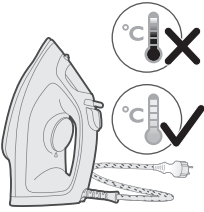

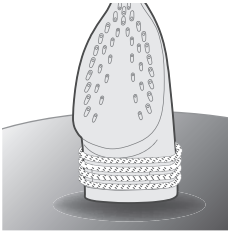

**13** Pozostaw żelazko do ostygnięcia.

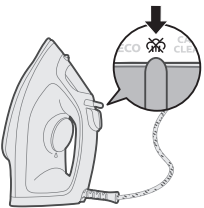

**14** Nawiń przewód wokół dolnej części urządzenia.

## Przechowywanie



**1** Przesuń przełącznik pary, aby wybrać tryb bez pary (prasowanie na sucho) .

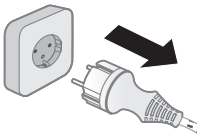

**2** Wyjmij wtyczkę urządzenia z gniazdka elektrycznego.



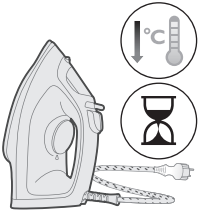

3 Poczekaj, aż urządzenie ostygnie.

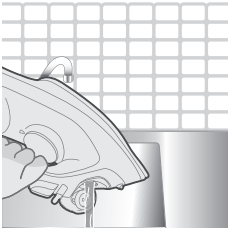

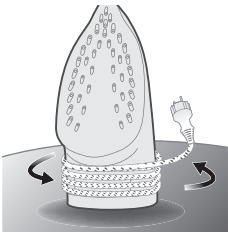

4 Wylej resztę wody ze zbiornika.





5 Nawiń przewód zasilający wokół głównej części urządzenia.

## Rozwiązywanie problemów

W tym rozdziale opisano najczęstsze problemy, z którymi można się zetknąć, korzystając z urządzenia. Jeśli poniższe wskazówki okażą się niewystarczające do rozwiązania problemu, odwiedź stronę [www.philips.com/support](http://www.philips.com/support), na której znajduje się lista często zadawanych pytań, lub skontaktuj się z Centrum Obsługi Klienta w swoim kraju.

Problem	Prawdopodobna przyczyna	Rozwiązanie
Żelazko nie usuwa zagnieceń.	Para nie jest wytwarzana podczas prasowania.	Napełnij zbiornik wodą i wybierz na przełączniku pary ustawienie  .
Żelazko w ogóle nie wytwarza pary.	W zbiorniku nie ma wystarczającej ilości wody.	Napełnij zbiornik wody.
	Przełącznik pary jest ustawiony na  .	Wybierz na przełączniku pary ustawienie  .

	Żelazko nie jest wystarczająco nagrzane, aby wytwarzać parę.	Gdy żelazko się nagrzewa, wskaźnik gotowości do prasowania świeci w sposób ciągły. Gdy żelazko będzie gotowe do użycia, wskaźnik przestanie świecić.
Na odzieży podczas prasowania występują krople wody.	Zbyt częste używanie funkcji silnego uderzenia pary w krótkim czasie.	Kontynuuj prasowanie w pozycji poziomej. Odczekaj chwilę przed ponownym użyciem funkcji silnego uderzenia pary.
	Pokrywka zbiornika wody nie jest prawidłowo zamknięta.	Docisnij pokrywkę, aż usłyszysz charakterystyczne kliknięcie.
Żelazko nie wytwarza silnego uderzenia pary.	Zbyt częste używanie funkcji silnego uderzenia pary w krótkim czasie.	Kontynuuj prasowanie w pozycji poziomej. Odczekaj chwilę przed ponownym użyciem funkcji silnego uderzenia pary.
	Żelazko nie jest wystarczająco nagrzane do prasowania.	Poczekaj, aż wskaźnik gotowości do prasowania przestanie migać i zacznie świecić w sposób ciągły.
	Do zbiornika wody wlane środki chemiczne.	Wypłucz zbiornik wody i nie wlewaj do niego perfum ani środków chemicznych.
Ze stopy żelazka kapie woda po jego odłączeniu od gniazdka elektrycznego.	Przełącznik pary jest ustawiony na  .	Wybierz na przełączniku pary ustawienie  .
	Żelazko z wodą w zbiorniku znajdowało się w pozycji poziomej.	Opróżniaj zbiornik wody po każdym użyciu żelazka lub przechowuj je w pozycji pionowej.
Żelazko pozostawia na odzieży połyskliwy ślad lub odcisk.	Prasowana powierzchnia była nierówna, czego przyczyną był np. szew lub fałda materiału.	Żelazkiem można bezpiecznie prasować wszystkie ubrania nadające się do prasowania. Połysk lub odcisk nie jest trwały i zniknie z odzieży po praniu. Unikaj prasowania na szwach i fałdach materiału. Aby nie dopuścić do powstawania odcisków, można także położyć na prasowanym miejscu bawełnianą szmatkę.

# Introdução

Parabéns pela sua aquisição e bem-vindo à Philips! Para tirar o máximo partido da assistência oferecida pela Philips, registe o seu produto em [www.philips.com/welcome](http://www.philips.com/welcome). Leia cuidadosamente este manual do utilizador, o folheto informativo importante e o guia de início rápido antes de utilizar o aparelho. Guarde-os para referência futura.

## Visão geral do produto

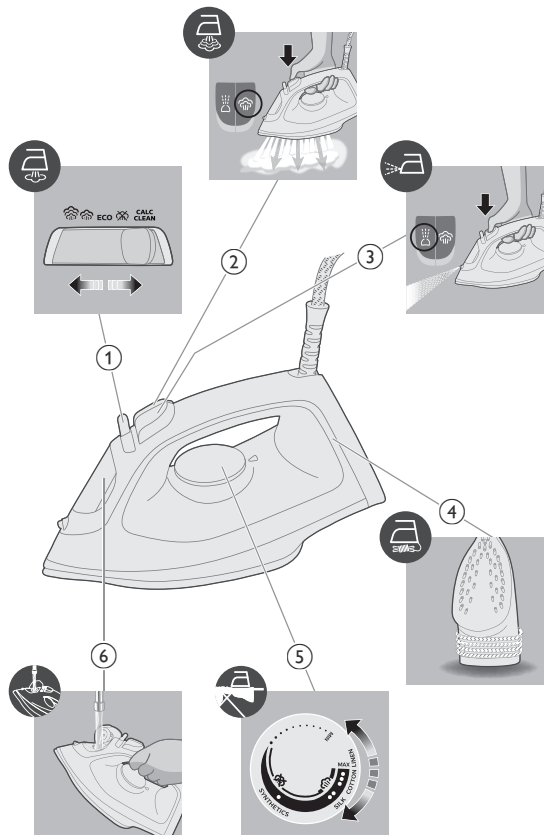

- 1 Seleção do vapor
- 2 Botão do jato de vapor
- 3 Borrifador de água
- 4 Enrolador do cabo
- 5 Botão da temperatura
- 6 Tampa do depósito de água

## Utilizar o aparelho

### Preparar para a utilização

Nota: o ferro pode libertar algum vapor quando o utiliza pela primeira vez. Isto deixa de acontecer passado pouco tempo.

#### Tipo de água a utilizar

O aparelho pode ser utilizado com água canalizada. No entanto, se viver numa área com água dura, recomendamos que misture água canalizada e água destilada ou desmineralizada em partes iguais. Isso evita a acumulação rápida de calcário e prolonga a vida útil do aparelho.

**Não adicione perfume, água de uma máquina de secar, vinagre, goma, agentes anticalcário, produtos para ajudar a engomar, água descalcificada quimicamente nem outros químicos, pois estes podem causar expelição de água, manchas castanhas ou danos no aparelho.**

### Encher o depósito de água

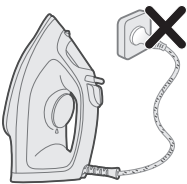

- 1 Não ligue o aparelho.

- 2 Certifique-se de que o aparelho arrefeceu.

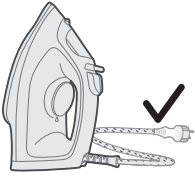

- 3 Deslize o botão de seleção de vapor para a direita para selecionar o modo sem vapor (passar a ferro a seco ~~OFF~~).

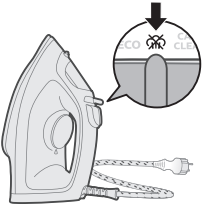

- 4 Abra a tampa do depósito de água.

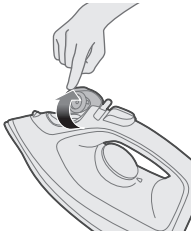

- 5 Encha o depósito com água até à indicação MAX no depósito de água.

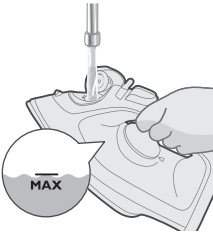

- 6 Feche a tampa do depósito de água firmemente.

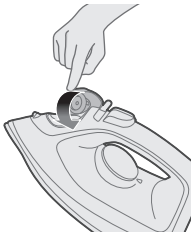

## Regular a temperatura



	MAX LINHO	
	● ● ● ● ALGODÃO	
	● ● SEDA	<b>ECO</b>
	● SINTÉTICO	



Regulação ECO: é produzido continuamente o mínimo de vapor constante para peças com menos vincos. Esta regulação também poupa energia.



Duas nuvens de vapor: é produzido continuamente o máximo de vapor constante para os vincos mais resistentes.



Três nuvens de vapor: é produzido continuamente o máximo de vapor constante para os vincos mais resistentes.

## Utilizar o aparelho

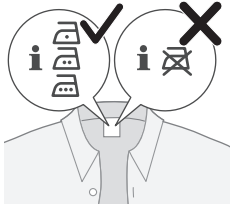

- 1 Consulte a etiqueta da peça de roupa para verificar a forma de engomar pretendida.

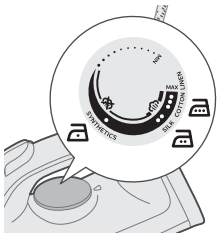

- 2 Regule o botão da temperatura para a temperatura pretendida, rodando-o para a indicação da temperatura adequada.

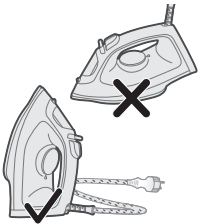

- 3 Coloque o ferro na posição de descanso.

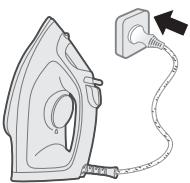

- 4 Ligue o aparelho a uma tomada com ligação à terra.

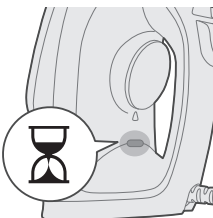

- 5 A luz de ferro pronto acende-se, indicando que o ferro está a aquecer.

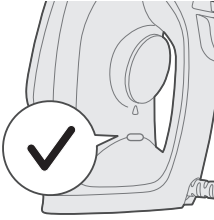

- 6 Quando a luz de ferro pronto se apagar, aguarde um pouco antes de começar a engomar. A luz de pronto acende-se ocasionalmente durante o funcionamento.

## Sem vapor/passar a seco

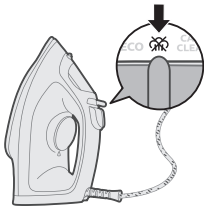

- 1 Defina a regulação de vapor para a opção sem vapor.

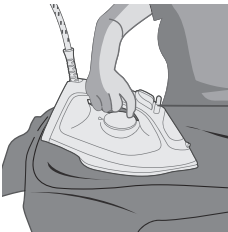

- 2 Após um curto período de tempo, o vapor para enquanto estiver a engomar.

## Borrifador de água

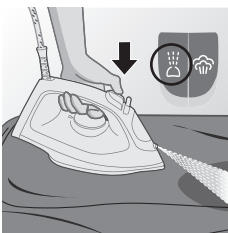

- 1 Defina a regulação de vapor para a opção sem vapor. Prima e liberte o botão do borrifador de água para largar um fluxo de vapor para remover os vincos persistentes.



## Jato de vapor

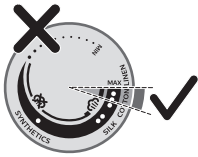

- 1 Regule o botão da temperatura para a posição MAX, entre algodão e linho.



- 2 Prima e solte o botão do jato de vapor para um jato potente de vapor para eliminar vincos difíceis.

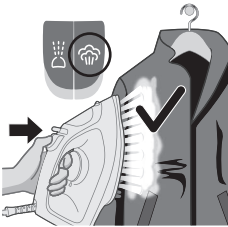

- 3 A função de jato de vapor pode ser utilizada quando tem o ferro na posição vertical para remover vincos de peças penduradas (apenas para DST2020 e DST2030).

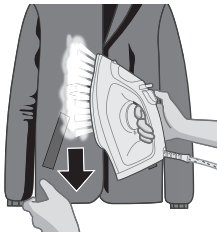

- 4 Puxe e estique a peça de roupa enquanto aplica o jato de vapor para remover os vincos persistentes (apenas para DST2020 e DST2030).



- 5 Não utilize as mãos desprotegidas como superfície de suporte quando engomar.

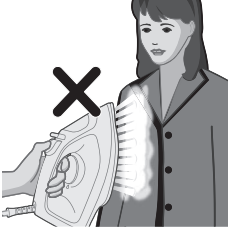

6 Não posicione o aparelho na sua direção/de outra pessoa.

## Desligar automático (DST2030)



1 Para lhe proporcionar tranquilidade, o aparelho irá arrefecer autonomamente se for deixado sem vigilância durante um período de tempo.

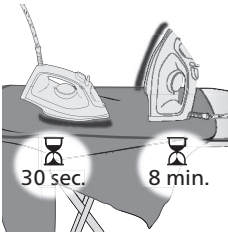
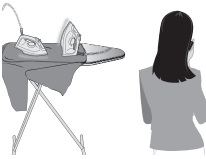

2 Quando o aparelho não é utilizado durante mais de 30 segundos após ser pousado sobre a base ou durante 8 minutos após ser colocado na sua posição de descanso, entra no modo de desativação automática.

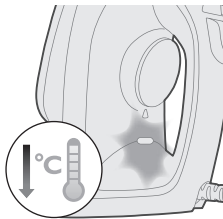

3 A temperatura do aparelho diminui no modo de desativação automática. A luz de ferro pronto fica intermitente para indicar que o aparelho está no modo de desativação automática. Para desligar completamente o aparelho, desligue-o da tomada.

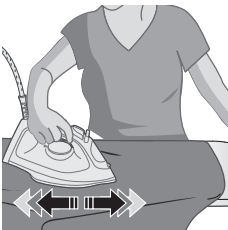

4 Para que aqueça novamente, pegue no aparelho ou movimente-o ligeiramente.

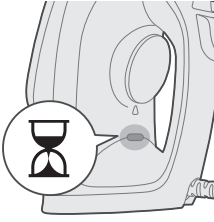

5 A luz de ferro pronto acende-se, indicando que o aparelho está a aquecer.

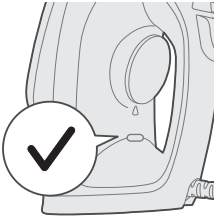

6 Quando a luz de ferro pronto se desligar, o aparelho está pronto a utilizar.

## Limpeza e manutenção

1 Certifique-se de que aparelho não está ligado à corrente.

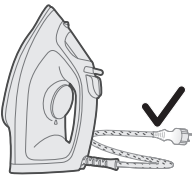
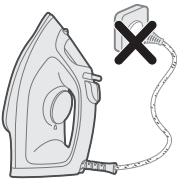

2 Certifique-se de que o aparelho arrefeceu.

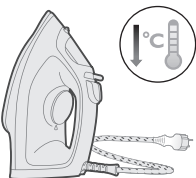

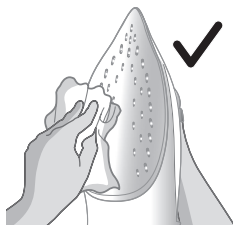

- 3 Limpe partículas e outros resíduos da base com um pano húmido.



Nota: Para manter a base do ferro lisa, evite o contacto direto com objetos metálicos. Nunca utilize esfregões, vinagre ou outros produtos químicos para limpar a base do ferro.

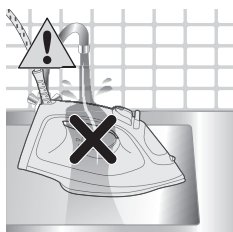

- 4 Não lave o aparelho em água corrente.

## Função Calc-clean

Sugestão: A função Quick Calc Release pode ser utilizada em qualquer altura. Caso viva numa zona de água dura, utilize a função com mais regularidade.



- 1 Após 1 mês de utilização, recomenda-se fazer uma limpeza do calcário para remover as partículas recolhidas do seu aparelho para prolongar a sua vida útil do mesmo e garantir que aquece corretamente.

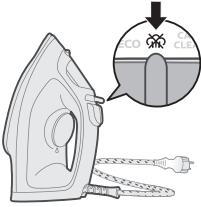

2 Assegure-se de que a ficha do ferro está desligada e o seletor de vapor está definido para a regulação a seco (passar a ferro a seco) .

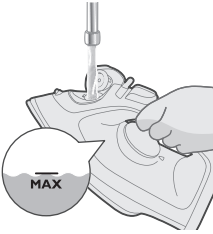

3 Encha o depósito com água até à indicação MAX.



4 Defina o botão da temperatura para MAX.

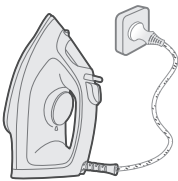

5 Ligue o aparelho a uma tomada com ligação à terra.

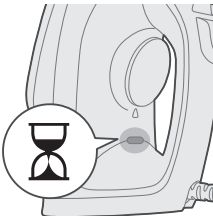

6 A luz de ferro pronto acende-se, indicando que o aparelho está a aquecer.

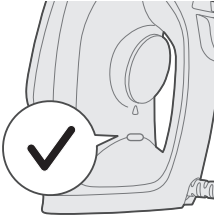

7 Aguarde até que a luz de ferro pronto se apague.

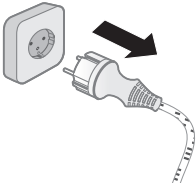

8 Desligue a ficha do ferro.

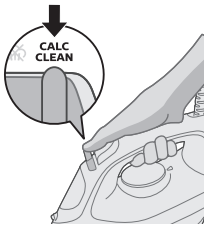

9 Deslize o seletor do vapor para a posição Calc-Clean e segure.



10 Segure o ferro sobre o lava-loiça e agite-o suavemente. A base irá libertar água quente e partículas de calcário.

Cuidado: enquanto o calcário é expelido, também saem vapor e água a ferver pela base.

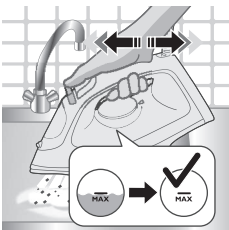

11 Agite suavemente o ferro até libertar toda a água no depósito de água.

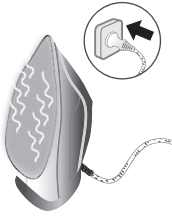

**12** Ligue o aparelho à tomada e deixe-o aquecer para secar a base. Tal demora cerca de 2 minutos.

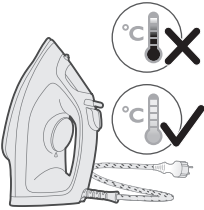

**13** Deixe o aparelho arrefecer.

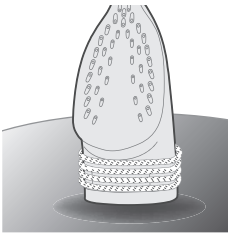

**14** Enrole o cabo de alimentação à volta da base do ferro.

## Armazenamento

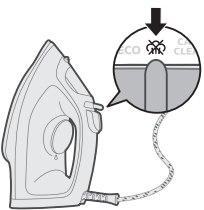

**1** Deslize o botão de seleção de vapor para selecionar o modo sem vapor (passar a ferro a seco) ~~☒~~.

**2** Desligue o aparelho da tomada elétrica.

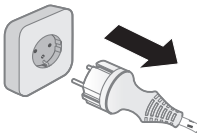

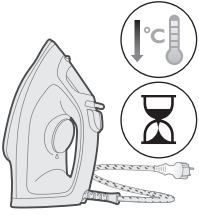

3 Deixe o aparelho arrefecer.

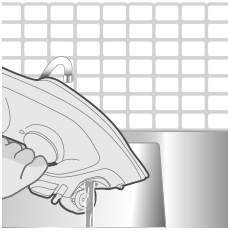

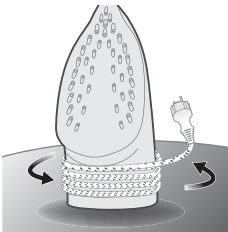

4 Esvazie a água que restar no depósito de água.





5 Enrole o cabo de alimentação à volta do corpo do aparelho.

## Resolução de problemas

Este capítulo resume os problemas mais comuns que podem surgir no aparelho. Se não conseguir resolver o problema com as informações fornecidas abaixo, visite [www.philips.com/support](http://www.philips.com/support) para consultar uma lista de perguntas frequentes ou contacte o Centro de Apoio ao Cliente no seu país.

Problema	Possível causa	Solução
O ferro não consegue eliminar vincos da peça de roupa.	Não é libertado vapor durante o engomar.	Encha o depósito de água e regule o seletor do vapor para  .
O ferro não produz vapor.	Não existe água suficiente no depósito.	Encha o depósito de água.
	O seletor de vapor está regulado para  .	Regule o seletor de vapor para  .



	O ferro ainda não está suficientemente quente para produzir vapor.	Quando o ferro estiver a aquecer, a luz indicadora de "ferro pronto" mantém-se continuamente acesa. Quando o ferro estiver pronto para ser utilizado, a luz apaga-se.
Caem gotas de água nos tecidos durante o engomar.	Utilizou a função de jacto com demasiada frequência num curto espaço de tempo.	Continue a engomar na horizontal e aguarde um pouco antes de voltar a utilizar a função jacto de vapor.
	A tampa do depósito da água não está fechada correctamente.	Prima a tampa até ouvir um "clique".
O ferro não produz um jacto de vapor.	Utilizou a função de jacto de vapor com demasiada frequência num curto espaço de tempo.	Continue a engomar na horizontal e aguarde um pouco antes de voltar a utilizar a função jacto de vapor.
	O ferro ainda não está suficientemente quente para engomar.	Aguarde até que a luz indicadora de "ferro pronto" pare de piscar e permaneça acesa.
	Colocou um químico no depósito da água.	Enxagúe o depósito de água e não coloque qualquer tipo de perfume ou produto químico no depósito de água.
Pinga água da base depois de o ferro ter sido desligado da tomada.	O selector de vapor está regulado para  .	Regule o selector de vapor para  .
	O ferro foi colocado na posição horizontal contendo ainda alguma água no reservatório.	Esvazie o depósito de água após a utilização, ou guarde o ferro na posição vertical.
O ferro deixa brilho ou marcas na peça de roupa.	A superfície para passar a ferro era irregular, por ex., passou o ferro sobre uma costura ou uma dobra na peça de roupa.	O ferro é seguro para utilizar em todas as peças de roupa que possam ser engomadas. O brilho ou a marca não são permanentes e desaparecem quando lava a peça de roupa. Evite passar o ferro sobre costuras ou dobras. Também pode colocar um pano de algodão sobre a área a engomar para evitar marcas.

# Introdução

Parabéns pela sua aquisição e bem-vindo à Philips! Para aproveitar ao máximo o suporte oferecido pela Philips, registre seu produto em [www.philips.com/welcome](http://www.philips.com/welcome). Leia atentamente este manual do usuário, o folheto de informações importantes e o guia de início rápido antes de usar o aparelho. Guarde-os para consultas futuras.

## Visão geral do produto

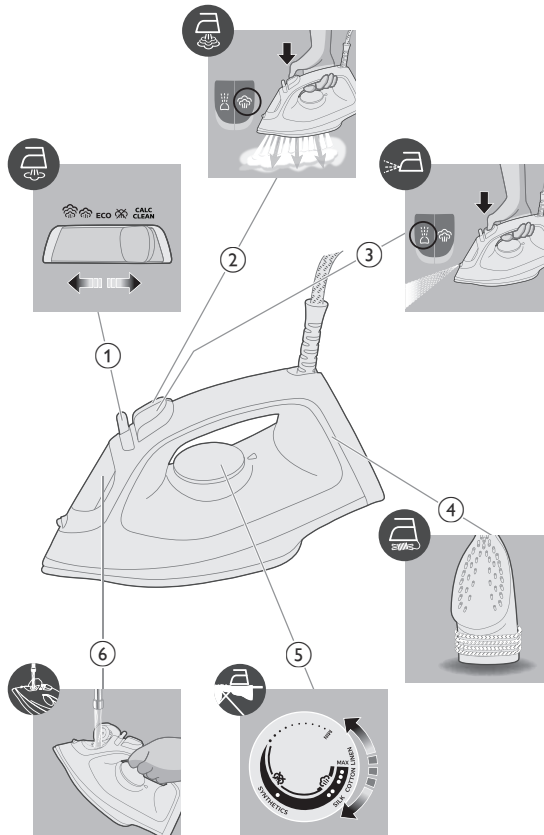

- 1 Seletor de vapor
- 2 Botão do sistema de vapor
- 3 Spray de água
- 4 Suporte para o fio
- 5 Termostato
- 6 Tampa do reservatório de água

## Utilização do aparelho

### Preparação para o uso

Nota: O ferro pode produzir uma pequena quantidade de vapor quando usado pela primeira vez. Em pouco tempo, isso não ocorrerá mais.

#### Tipo de água usado

O aparelho é adequado para uso com água corrente. No entanto, se você mora em uma área com água dura, recomendamos misturar uma quantidade igual de água da torneira com água destilada ou desmineralizada. Isso evitará o acúmulo rápido de impurezas e prolongará a vida útil do aparelho.

**Não adicione perfume, água da secadora, vinagre, amido, agentes removedores de impurezas, produtos para passar roupas, água quimicamente descalcificada ou outros produtos químicos, pois podem causar jatos de água, manchas escuras ou danos ao aparelho.**

### Abastecimento do reservatório de água

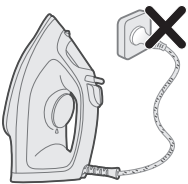

- 1 Não conecte o aparelho.

2 Certifique-se de que o aparelho esteja frio.

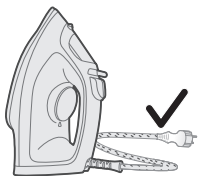

3 Deslize o seletor de vapor para a direita para selecionar o modo sem vapor (passar a seco) ~~☒~~.

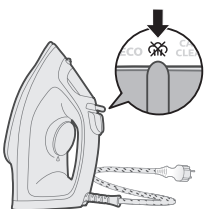

4 Abra a tampa do reservatório de água.

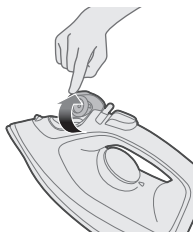

5 Encha o reservatório de água até a indicação MÁX no reservatório de água.

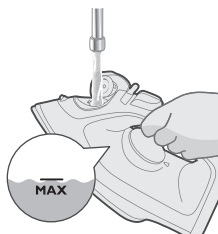

6 Feche bem a tampa do reservatório de água.

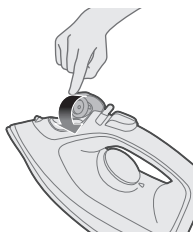

## Ajuste da temperatura



	MÁX LINHO	
	● ● ● ALGODÃO	
	● ● SEDA	<b>ECO</b>
	● SINTÉTICO	

ECO



Ajuste ECO: Vapor mínimo e constante fornecido continuamente para roupas com menos vincos. Este ajuste também economiza energia.



Duas nuvens de vapor: Vapor máximo e constante fornecido continuamente para eliminar os vincos difíceis.



Três nuvens de vapor: Vapor máximo e constante fornecido continuamente para eliminar os vincos mais difíceis.

## Utilização do aparelho

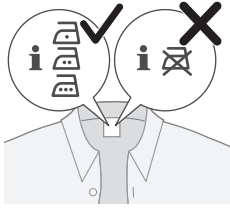

- 1 Verifique a etiqueta da roupa para saber as informações necessárias para passar a roupa.

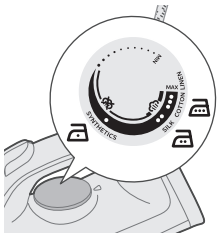

- 2 Ajuste o botão de temperatura para a temperatura desejada para passar a roupa, girando-o para a indicação de temperatura apropriada.

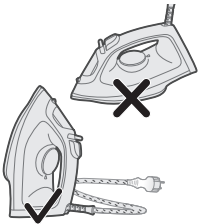

- 3 Deixe que o ferro descanse na posição vertical.

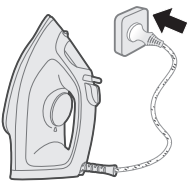

- 4 Conecte o aparelho a uma tomada de parede aterrada.

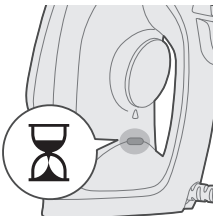

- 5 A luz de "ferro pronto" acenderá indicando que o ferro está esquentando.

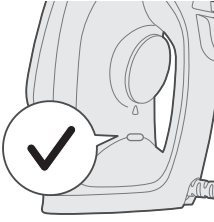

- 6 Quando a luz indicadora de ferro pronto apagar, espere um pouco antes de começar a passar. A luz indicadora de ferro pronto acende às vezes durante o uso.

## Sem vapor/passar a seco

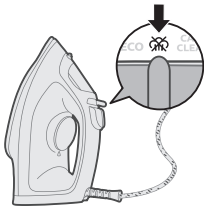

- 1 Ajuste a configuração de vapor para sem vapor.

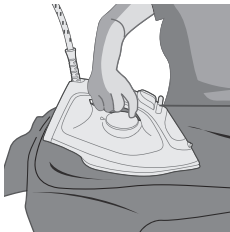

- 2 Após um breve período, o vapor cessará enquanto você passa a roupa.

## Spray de água

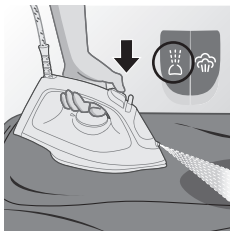

- 1 Ajuste a configuração de vapor para sem vapor. Pressione e solte o botão do spray de água para obter um jato de névoa para remover vincos mais difíceis.

## Sistema de vapor

- 1 Ajuste o botão de temperatura para o ajuste MÁX entre algodão e linho.

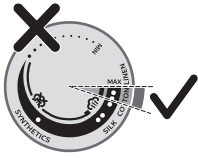

- 2 Pressione e solte o botão do sistema de vapor para aplicar um poderoso jato de vapor para remover os vincos mais difíceis.



- 3 Você pode usar a função do sistema de vapor com o ferro na posição vertical enquanto remove os vincos das roupas penduradas (apenas para DST2020 e DST2030).

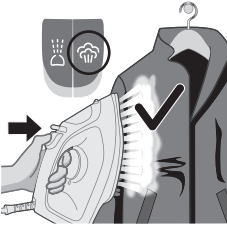

- 4 Puxe e estique a peça enquanto aplica o jato de vapor para remover os vincos mais difíceis (apenas para DST2020 e DST2030).

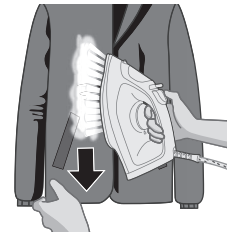

- 5 Não use a mão nua como superfície de apoio ao usar o ferro.





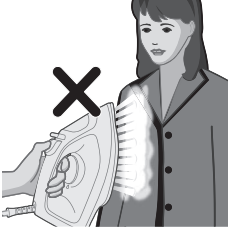

- 6 Não posicione o aparelho na sua direção ou de outra pessoa.

## Desligamento automático (DST2030)



- 1 Para a sua tranquilidade, o aparelho resfria-se sozinho se não for supervisionado por um tempo.

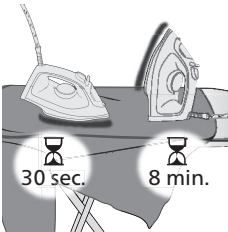
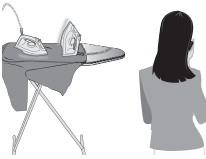

- 2 Quando o aparelho não for usado por mais de 30 segundos apoiado na base ou 8 minutos apoiado na posição de descanso/base, o aparelho entrará no modo de desligamento automático.

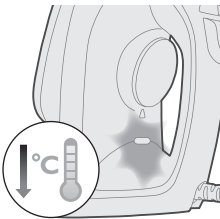

- 3 A temperatura do aparelho diminuirá no modo de desligamento automático. A luz indicadora de ferro pronto também piscará sem parar para indicar que o aparelho está no status de desligamento automático. Para desligar o aparelho completamente, desconecte-o da tomada.

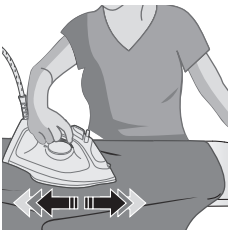

- 4 Para aquecer o aparelho novamente, segure-o ou movimente-o devagar.

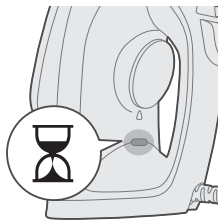

5 A luz de "ferro pronto" acenderá indicando que o aparelho está esquentando.

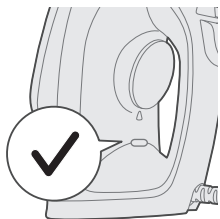

6 Assim que a luz indicadora de "ferro pronto" apagar, o aparelho estará pronto para uso.

## Limpeza e manutenção

1 Certifique-se de que o aparelho não está conectado à tomada elétrica.

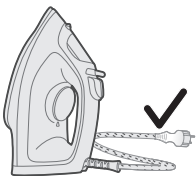
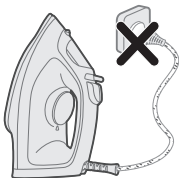

2 Certifique-se de que o aparelho esfriou.

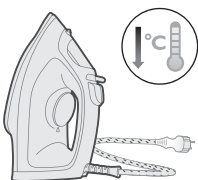

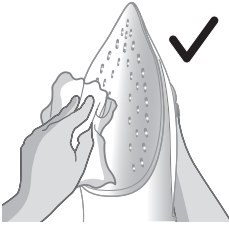

- 3 Limpe os flocos e outros depósitos da base com um pano úmido.



Nota: Mantenha a base lisa e evite o contato direto com objetos metálicos. Nunca use palha de aço, vinagre ou outras substâncias químicas para limpar a base.



- 4 Não lave/limpe o aparelho com água corrente.

## Calc-Clean



Dica: A função Quick Calc Release pode ser usada a qualquer momento. Se você vive em uma área de água dura, use a função com mais frequência.

- 1 Após 1 mês de uso, recomenda-se realizar a limpeza de calcário para remover as impurezas coletadas no aparelho, prolongar sua vida útil e garantir o aquecimento do aparelho.

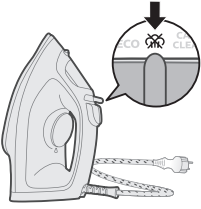

2 Verifique se o ferro está desconectado e se o ajuste de vapor está na posição sem vapor (passar a seco) .

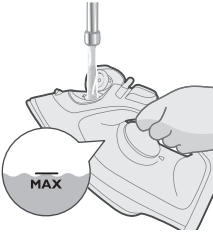

3 Encha o reservatório de água até a indicação MÁX.



4 Defina o controle de temperatura como MÁX.

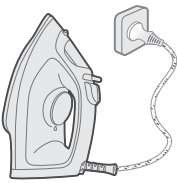

5 Conecte o aparelho a uma tomada de parede aterrada.

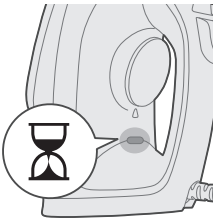

6 A luz de "ferro pronto" acenderá indicando que o aparelho está esquentando.

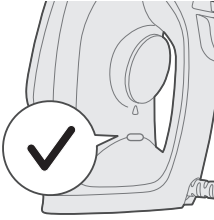

7 Aguarde até que a luz indicadora de ferro pronto apague.

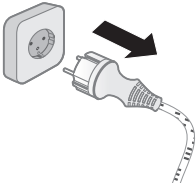

8 Desconecte o ferro.

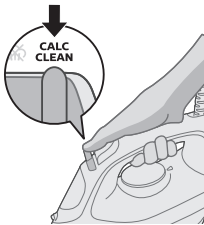

9 Deslize o seletor do vapor até a posição Calc-Clean e segure-o.



10 Segure o ferro sobre a pia e sacuda-o suavemente. Água quente e partículas calcificadas serão liberadas da base do ferro.

Cuidado: No momento em que as impurezas saírem, também sairão vapor e água quente da base do ferro.

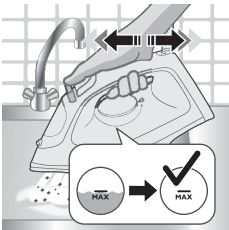

11 Continue balançando o ferro suavemente até que toda a água no reservatório tenha sido liberada.

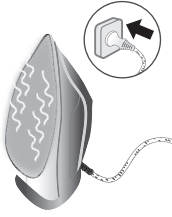

**12** Conecte o aparelho à tomada e deixe-o esquentar para secar a base. Esse processo demora cerca de 2 minutos.

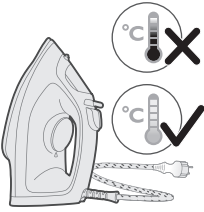

**13** Deixe o ferro esfriar.

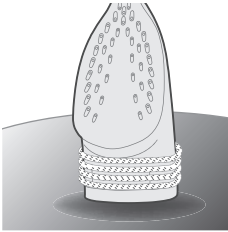

**14** Enrole o fio em volta da base do ferro.

## Armazenamento

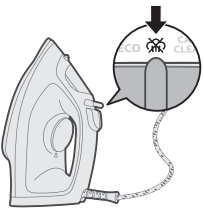

**1** Deslize o seletor de vapor para selecionar o modo sem vapor (passar a seco) ~~OFF~~.

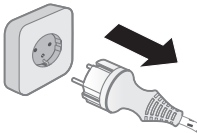

**2** Desligue o aparelho da tomada.

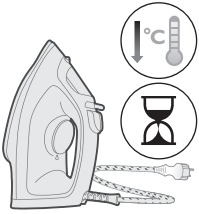

3 Deixe o aparelho esfriar.

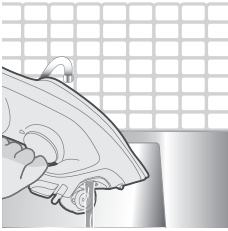

4 Retire toda a água restante no reservatório de água.

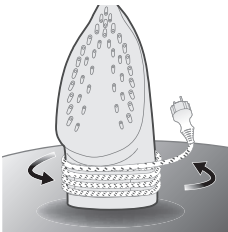

5 Enrole o cabo de energia em torno da estrutura do aparelho.

## Solução de problemas

Este capítulo resume os problemas mais comuns que você pode encontrar no aparelho. Caso você não consiga solucionar o problema com as informações abaixo, acesse [www.philips.com/support](http://www.philips.com/support) para obter uma lista de perguntas frequentes ou entre em contato com a Central de Atendimento ao Cliente do seu país.

Problema	Possível causa	Solução
O ferro não consegue remover os amassados da roupa.	Não há produção de vapor ao passar a roupa.	Encha o reservatório de água e ajuste o controle deslizante de vapor para ☁.
O ferro não produz vapor.	O reservatório não possui água suficiente.	Encha o reservatório de água.
	O controle deslizante de vapor está definido como ☁.	Regule o controle deslizante de vapor para ☁.

	O ferro não está quente o suficiente para produzir vapor.	Enquanto o ferro estiver aquecendo, a luz indicadora de "ferro pronto" estará acesa. Quando o ferro estiver pronto para uso, a luz se apagará.
Pingos d'água caem na peça de roupa durante o uso o ferro.	A função de vapor extra foi usada muitas vezes em um curto período.	Continue passando na posição horizontal e aguarde um pouco antes de usar novamente a função do sistema de vapor.
	Você não fechou corretamente a tampa do reservatório de água.	Pressione a tampa até ouvir um "clique".
O ferro produz vapor em pouca quantidade.	A função do sistema de vapor foi usada muitas vezes em um curto período.	Continue passando na posição horizontal e aguarde um pouco antes de usar novamente a função do sistema de vapor.
	O ferro ainda não está quente o suficiente para ser usado.	Espere até que luz indicadora de "ferro pronto" tenha parado de piscar e fique acesa.
	Você colocou um produto químico no reservatório de água.	Enxágue o reservatório de água e não coloque nenhum perfume ou produto químico nele.
A água escorre da base depois que o ferro é desligado.	O controle deslizante de vapor está definido como  .	Regule o controle deslizante de vapor para  .
	Você colocou o ferro na posição horizontal e o reservatório de água não estava vazio.	Esvazie o reservatório de água após o uso ou guarde o ferro na posição vertical.
O ferro deixa brilho ou uma marca na peça de roupa.	A superfície a ser passada estava desnivelada, por exemplo, por ter passado o ferro sobre uma costura ou uma dobra na peça de roupa.	O ferro pode ser utilizado com segurança em todas as peças de roupa. O brilho ou a marca não é permanente e desaparecerá ao lavar a peça de roupa. Evite passar o ferro por cima de costuras ou dobras. Você também pode colocar um pano de algodão sobre a área na qual o ferro será passado para evitar marcas.



# Introducere

Felicitări pentru achiziție și bun venit la Philips! Pentru a beneficia pe deplin de asistența oferită de Philips, înregistrează-ți produsul la [www.philips.com/welcome](http://www.philips.com/welcome). Citește cu atenție acest manual de utilizare, pagina cu informații importante și ghidul de inițiere rapidă înainte de a utiliza aparatul. Păstrează-le pentru consultare ulterioară.

## Prezentare generală a produsului

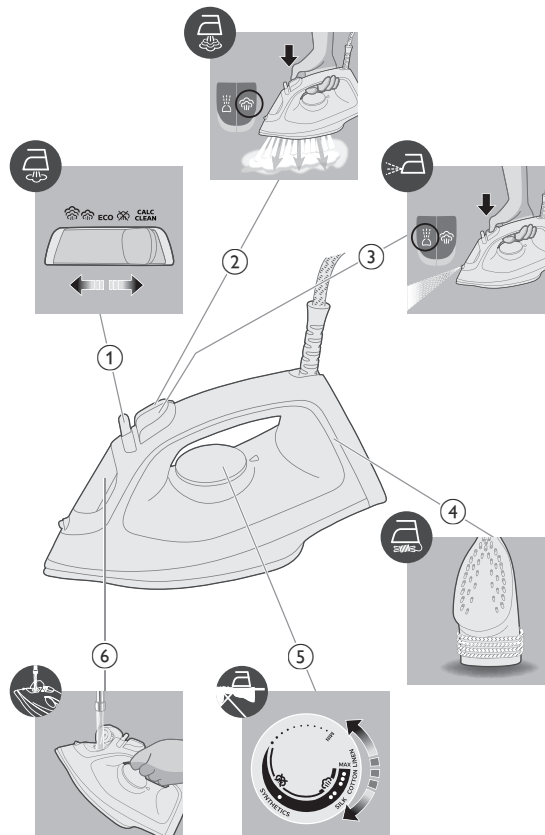

- 1 Selector de abur
- 2 Buton pentru jet de abur
- 3 Pulverizare cu apă
- 4 Înfășurarea cablului
- 5 Selector de temperatură
- 6 Capacul rezervorului de apă

## Utilizarea aparatului

### Pregătirea pentru utilizare

Notă: este posibil ca fierul de călcat să producă puțin abur la prima utilizare. Acest fenomen încetează în scurt timp.

#### Tipul de apă de utilizat

Aparatul poate fi folosit cu apă de la robinet. Totuși, dacă locuiești într-o zonă cu apă dură, îți recomandăm să amesteci o cantitate egală de apă de la robinet cu apă distilată sau demineralizată. Acest lucru va preveni acumularea rapidă a calcarului și va prelungi durata de viață a aparatului.

**Nu adăuga parfum, apă din mașina de uscat prin centrifugare, oțet, amidon, agenți de detartrare, aditivi de călcare, apă dedurizată chimic sau alte substanțe chimice, deoarece acestea pot provoca vârsarea apei, colorarea în maro sau deteriorarea aparatul tău.**

### Umplerea rezervorului de apă

- 1 Nu conecta aparatul la priză.

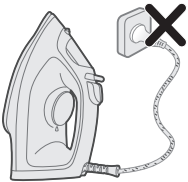

- 2 Asigură-te că aparatul s-a răcit.

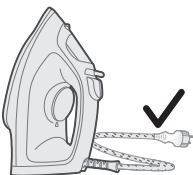

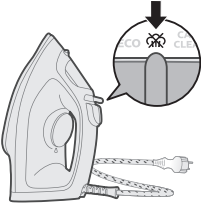

3 Glisează selectorul de abur la dreapta pentru a selecta modul fără abur (călcat uscat) .

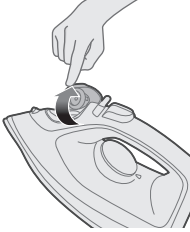

4 Deschide capacul rezervorului de apă.

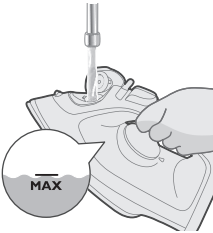

5 Umple rezervorul de apă până la indicatorul MAX de pe rezervor.



6 Închide bine capacul rezervorului de apă.

## Setarea temperaturii



MAX  
IN



● ● ●  
BUMBAC





ECO

MĂTASE



MATERIALE SINTETICE



ECO



Setarea ECO: este eliberată continuu o cantitate minimă și constantă de abur pentru articole de îmbrăcăminte cu mai puține cute. Această setare economisește, de asemenea, energie.

Doi norișori de abur



Doi norișori de abur: este eliberată continuu o cantitate mai mare și constantă de abur pentru îndepărtarea cutelor dificile.

Trei norișori de abur



Trei norișori de abur: este eliberată continuu o cantitate maximă și constantă de abur pentru îndepărtarea cutelor persistente.

## Utilizarea aparatului

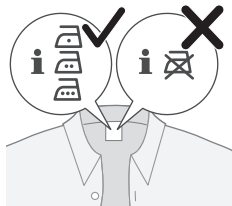

- 1 Verifică eticheta articolului vestimentar pentru informații despre cum se calcă.

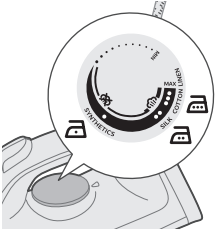

- 2 Setează selectorul de temperatură la temperatura de călcare necesară rotindu-l la indicația de temperatură corespunzătoare.

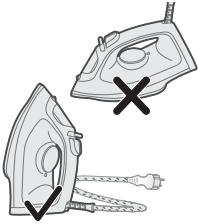

- 3 Lasă fierul de călcat în poziție verticală.

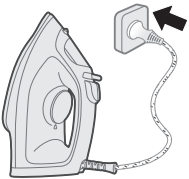

- 4 Conectează aparatul la o priză de perete cu împământare.

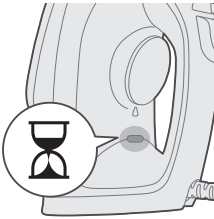

- 5 Ledul „fier de călcat pregătit” se va aprinde, indicând faptul că fierul se încălzește.

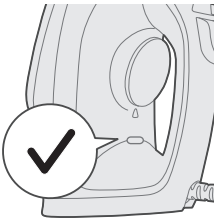

- 6 După ce ledul „fier de călcat pregătit” se stinge, așteaptă puțin înainte de a începe să calci. Ledul „pregătit” se va aprinde din când în când în timpul călcatului.

## Fără abur/călcăt uscat

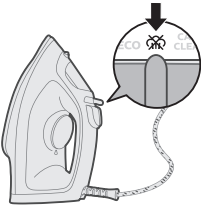

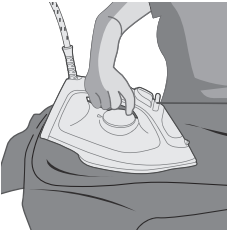

- 1 Configurează setarea pentru abur la fără abur.

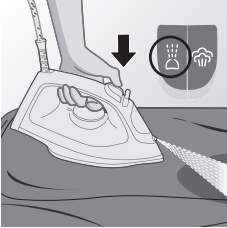

- 2 După scurt timp, nu se va mai elibera abur în timpul călcatului.

## Pulverizare cu apă



- 1 Configurează setarea pentru abur la fără abur. Apasă și eliberează butonul de pulverizare cu apă  pentru un jet de abur fin pentru îndepărtarea cutelor persistente.

## Jet de abur

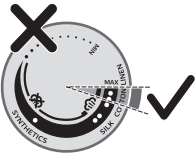

- 1 Setează selectorul de temperatură la setarea MAX între bumbac și in.

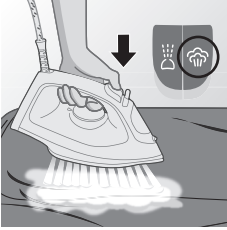

- 2 Apasă și eliberează butonul pentru jet de abur pentru un jet puternic de abur pentru îndepărtarea cutelor persistente.

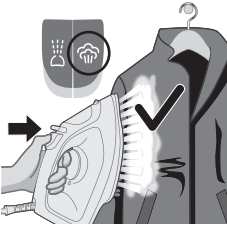

- 3 Poți utiliza funcția jet de abur când ții fierul în poziție verticală pentru îndepărtarea cutelor de pe hainele de pe umeraș (doar pentru DST2020 și DST2030).

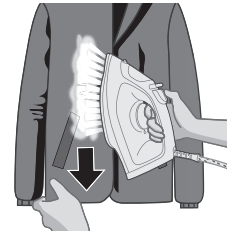

- 4 Trage și întinde articolul vestimentar în timp ce aplici jet de abur pentru a îndepărta cutele persistente (doar pentru DST2020 și DST2030).



- 5 Nu folosi mâna goală ca suprafață de sprijin când calci.

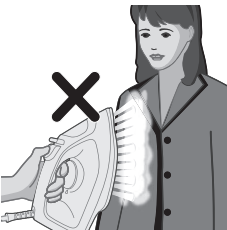

- 6 Nu poziționa aparatul spre tine/altă persoană.

## Modul de oprire automată (DST2030)



- 1 Pentru comoditate, aparatul se poate răci singur dacă este lăsat nesupravegheat o perioadă de timp.

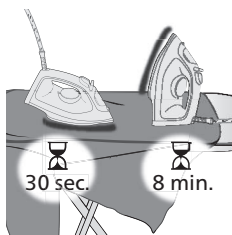

- 2 Atunci când aparatul stă pe talpă și nu a fost utilizat de mai mult de 30 de secunde sau este așezat pe călcâi/bază și nu a fost utilizat de mai mult de 8 minute, acesta va intra în modul de oprire automată.

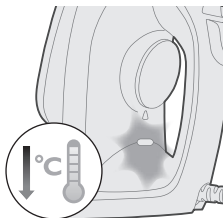

- 3 Temperatura aparatului va scădea în modul de oprire automată. Ledul „fier de călcat pregătit” se va aprinde continuu intermitent pentru a indica faptul că aparatul este în starea de oprire automată. Pentru a opri complet aparatul, scoate-l din priză.

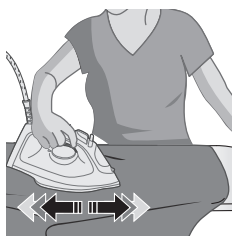

- 4 Pentru a lăsa aparatul să se încălzească din nou, ridică-l sau deplasează-l ușor.

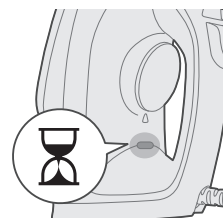

- 5 Ledul „fier de călcat pregătit” se va aprinde, indicând faptul că aparatul se încălzește.



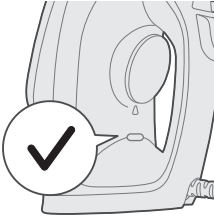

- 6 După ce ledul „fier de călcat pregătit” se stinge, aparatul este gata de utilizare.

## Curățare și întreținere

- 1 Asigură-te că aparatul nu este conectat la priză.

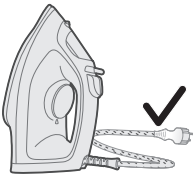
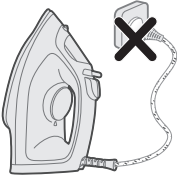

- 2 Asigură-te că aparatul s-a răcit.

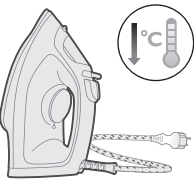

- 3 Șterge reziduurile și alte depuneri de pe talpă cu o cârpă umedă.





Notă: pentru a menține talpa netedă, evită contactul dur cu obiecte metalice. Nu folosi niciodată bureți de sârmă, oțet sau alte substanțe chimice pentru a curăța talpa.

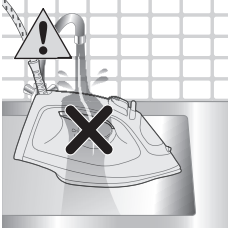

4 Nu spăla/curăța aparatul sub jet de apă.

## Funcția Calc-Clean



Sugestie: funcția Quick Calc Release poate fi utilizată în orice moment. Dacă locuiești într-o zonă cu apă dură, folosește funcția mai frecvent.

1 După 1 lună de utilizare, se recomandă să efectuezi detartarea pentru a îndepărta particulele de calcar colectate din aparat, astfel încât să-i prelungi durata de viață și să te asiguri că se încălzește.

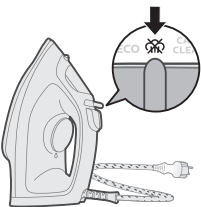

2 Asigură-te că fierul de călcat este deconectat de la priză și că setarea pentru abur este setată la modul fără abur (călcat uscat) .

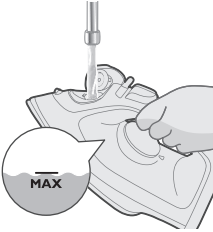

3 Umple rezervorul de apă până la indicatorul MAX.



4 Setează selectorul de temperatură la MAX.

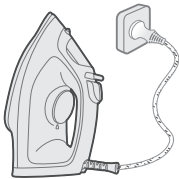

5 Conectează aparatul la o priză de perete cu împământare.

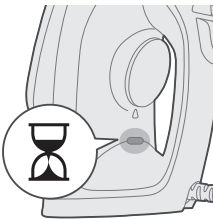

6 Ledul „fier de călcat pregătit” se va aprinde, indicând faptul că aparatul se încălzește.

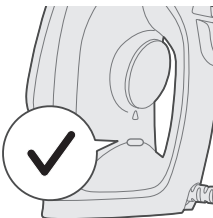

7 Așteaptă ca ledul „fier de călcat pregătit” să se stingă.

8 Scoate fierul din priză.

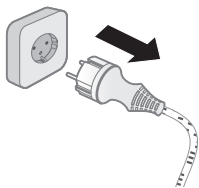

9 Pune selectorul de abur în poziția Calc-Clean și menține-l.

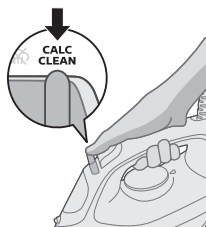

10 Ține fierul deasupra chiuvetei și scutură-l ușor. Din talpă vor ieși apă fierbinte și particule de calcar.



Atenție: în timp ce calcarul este eliminat, din talpă ies și abur și apă fierbinte.

11 Continuă să scuturi fierul de călcat până când se consumă toată apa din rezervorul de apă.

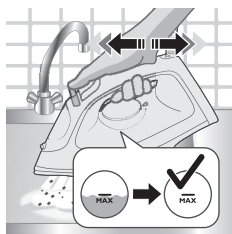

12 Conectează aparatul la priză și lasă-l să se încălzească pentru a usca talpa. Durează aproximativ 2 minute.



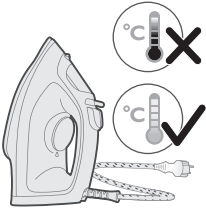

13 Lasă fierul să se răcească.

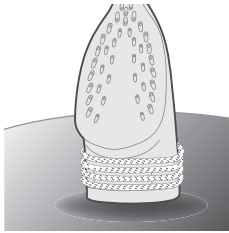

14 Înfășoară cablul de alimentare în jurul călcâiului aparatului.

## Depozitarea

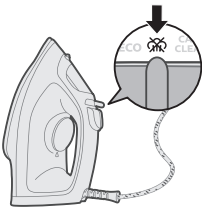

1 Glisează selectorul de abur pentru a selecta modul fără abur (călcat uscat) 

2 Scoate aparatul din priză.

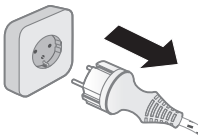

3 Lasă aparatul să se răcească.

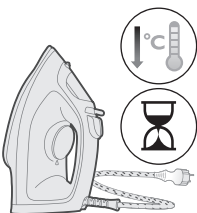

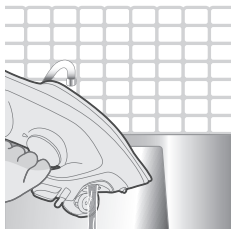

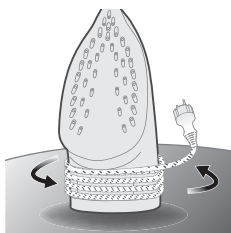

4 Golește apa rămasă din rezervorul de apă.





5 Înfășoară cablul de alimentare în jurul corpului principal al aparatului.

## Depanare

Acest capitol descrie cele mai frecvente probleme pe care le poți avea la utilizarea aparatului. Dacă nu poți rezolva problema cu ajutorul informațiilor de mai jos, accesează [www.philips.com/support](http://www.philips.com/support), unde vei găsi o listă de întrebări frecvente, sau contactează Centrul de asistență pentru clienți din țara ta.

Problemă	Cauză posibilă	Soluție
Fierul de călcat nu poate îndepărta cutele de pe articolul de îmbrăcăminte.	Nu există abur deloc în timpul călcării.	Umple rezervorul de apă și setează glisorul pentru abur la  .
Aparatul nu mai produce abur.	Nu este suficientă apă în rezervor.	Umple rezervorul de apă.
	Glisorul pentru abur este reglat pe poziția  .	Reglează glisorul pentru abur pe poziția  .
	Fierul nu este încă suficient de încălzit pentru a produce abur.	În timp ce aparatul se încălzește, ledul „fier de călcat pregătit” este aprins continuu. Când aparatul este gata de utilizare, ledul se stinge.
Picură apă pe material în timpul călcării.	Ai folosit prea des funcția pentru jet de abur într-un interval de timp foarte scurt.	Continuă călcarea în poziție orizontală și așteaptă puțin înainte de a folosi din nou funcția jet de abur.
	Nu ați închis bine capacul rezervorului de apă.	Apasă pe capac până când auzi un clic.

Fierul de călcat nu produce jet de abur.	Ai folosit prea des funcția pentru jet de abur într-un interval de timp foarte scurt.	Continuă călcarea în poziție orizontală și așteaptă puțin înainte de a folosi din nou funcția jet de abur.
	Fierul nu este suficient de încins pentru a călca.	Așteaptă până când ledul „fier de călcat pregătit” nu mai luminează intermitent și rămâne aprins continuu.
	Ați pus o substanță chimică în rezervorul de apă.	Clătește rezervorul de apă și nu introdu niciun fel de parfum sau substanțe chimice în acesta.
Din talpă se scurg picături de apă după ce fierul a fost scos din priză.	Glisorul pentru abur este reglat pe poziția  .	Reglează glisorul pentru abur pe poziția  .
	Ai pus fierul de călcat în poziție orizontală când mai era apă în rezervor.	Golește rezervorul de apă după utilizare sau depozitează fierul în poziție verticală.
Fierul de călcat lasă o urmă lucioasă sau o amprentă pe articolul de îmbrăcăminte.	Suprafața călcată a fost neuniformă, de exemplu deoarece ați călcat peste un tighel sau o cută de pe articolul vestimentar.	Fierul poate fi utilizat în siguranță pe toate articolele vestimentare care pot fi călcate. Urma lucioasă sau amprenta nu este permanentă și dispare când speli articolul vestimentar. Evită să calci peste cusături și cute. Pentru a evita amprente, poți așeza o bucată de bumbac peste zona care trebuie călcată.

# Hyrje

Urime për blerjen dhe mirë se vini te Philips! Për të përfutur plotësisht nga mbështetja që ofron Philips, regjistroni produktin në faqen [www.philips.com/welcome](http://www.philips.com/welcome). Lexojini me kujdes manualin e përdorimit, fletëpalosjen e informacionit të rëndësishëm dhe manualin e shpejtë përpara se ta përdorni pajisjen. Ruajini për referencë në të ardhmen.

## Përmbledhje e produktit

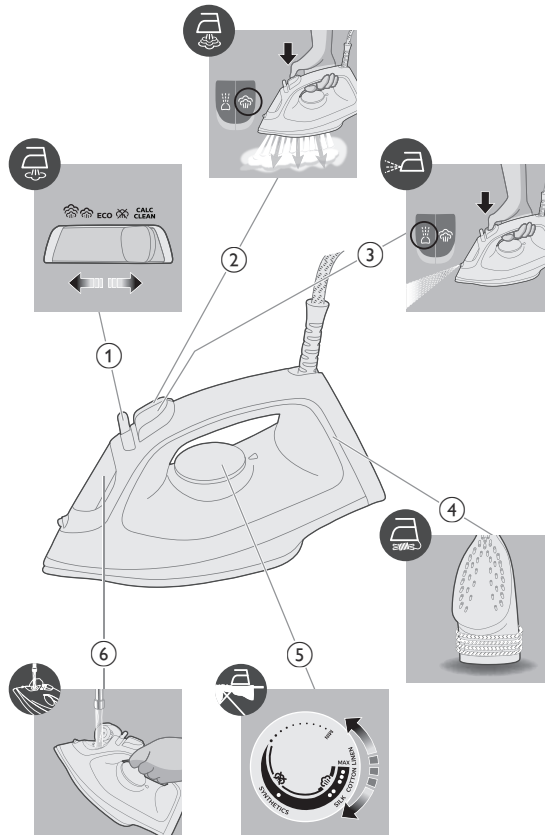



- 1 Përzgjedhësi i avullit
- 2 Butoni i përforcimit të avullit
- 3 Spërkatësi i ujit
- 4 Mbështjellja e kordonit
- 5 Çelësit rrotullues i temperaturës
- 6 Kapaku i depozitës së ujit

## Përdorimi i pajisjes

### Përgatitja për përdorim

Shënim: Hekuri mund të lëshojë pak avull kur e përdorni për herë të parë. Ky pushon pas pak çastesh.

#### Lloji i ujit për përdorim

Pajisja është e përshtatshme për përdorim me ujë rubineti. Por megjithatë, nëse banoni në zona me ujë të fortë, ne rekomandojmë të përzieni një sasi të barabartë uji nga çezma me ujë të distiluar ose të çminalizuar. Kjo parandalon formimin e shpejtë të bigorrit dhe rrit jetëgjatësinë e pajisjes.

**Mos shtoni parfum, ujë nga tharësja e rrobave, uthull, niseshte, solucione zhgëlqerëzimi, solucione për hekurosje, ujë të pastruar nga gëlqerja me procese kimike, pasi këto mund të shkaktojnë dalje të ujit, njollosjen apo dëmtimin e pajisjes suaj.**

### Mbushja e depozitës së ujit

- 1 Mos e futni pajisjen në prizë.

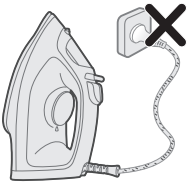

- 2 Sigurohuni që pajisja është ftohur.

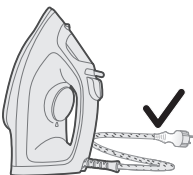

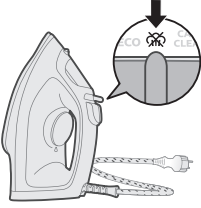

3 Rrëshqitni përzgjedhësin e avullit në të djathtë për të zgjedhur modalitetin pa avull (hekurosje në të thatë) .

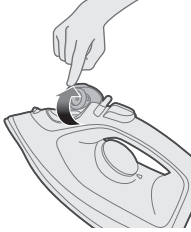

4 Hapni kapakun e depozitës së ujit.

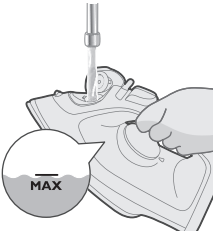

5 Mbusheni depozitën e ujit deri në treguesin MAX që gjendet në depozitë.



6 Mbylleni mirë kapakun e depozitës së ujit.

## Vendosja e temperaturës



MAX  
LINO



● ● ●  
PAMBUK





MËNDAFSH

ECO



SINTETIKE



ECO



Cilësimi ECO: Nxirret vazhdimisht një sasi minimale avulli për veshjet me pak rrudha. Ky cilësim kursen edhe energji.



Dy re avulli: Nxirret vazhdimisht më shumë avull konstant për rrudhat e vështira.



Tre re avulli: Nxirret vazhdimisht një sasi maksimale avulli për rrudhat e vështira.

## Përdorimi i pajisjes

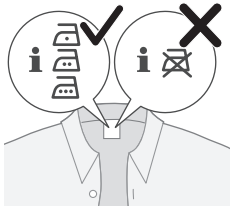

1 Kontrolloni etiketën e veshjes për të parë mënyrën e duhur të hekurosjes.

## 340 Shqip

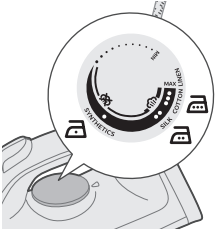

- 2 Vendosni çelësin rrotullues të temperaturës në temperaturën e duhur të hekurosjes, duke e caktuar në treguesin e përshtatshëm të temperaturës.

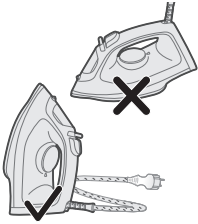

- 3 Lëreni hekurin të qëndrojë mbështetur mbi pjesën fundore.

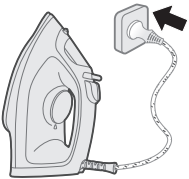

- 4 Futeni pajisjen në prizë të tokëzuar.

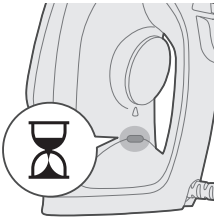

- 5 Drita që tregon se hekuri është gati do të ndizet për të treguar se hekuri po nxehet.

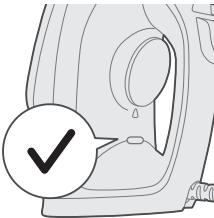

- 6 Kur drita që tregon se hekuri është gati fiket, prisni pak përpara se të filloni hekurosjen. Drita që tregon se hekuri është gati do të ndizet the fiket disa herë gjatë hekurosjes.

## Pa avull/Hekurosje në të thatë

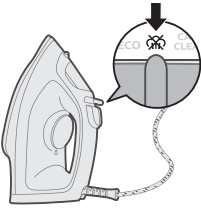

- 1 Vendosni cilësimin e avullit në cilësimin pa avull.

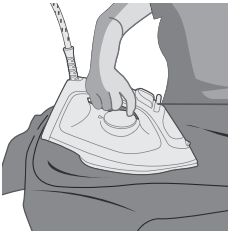

- 2 Pas një kohe të shkurtër, nxjerrja e avullit do të ndalojë gjatë hekurosjes.

## Spërkatësi i ujit

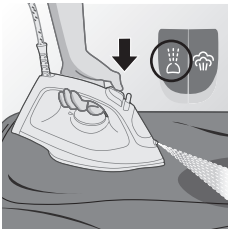

- 1 Vendosni cilësimin e avullit në cilësimin pa avull. Shtypni dhe lëshoni butonin e spërkatjes së ujit për një rrjedhë avulli, për të hequr rrudhat e vështira.

## Përforcuesi i avullit

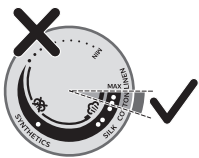

- 1 Vendosni çelësin rrotullues të temperaturës në cilësimin MAX mes pambukut dhe linosë.

## 342 Shqip



2 Shtypni dhe lëshoni butonin e përforcimit të avullit për një përforcim të fuqishëm të avullit për heqjen e rrudhave të vështira.



3 Mund të përdorni funksionin e përforcimit të avullit kur e mbani hekurin në pozicionin vertikal për heqjen e rrudhave nga veshjet e varura (vetëm për DST2020 dhe DST2030).

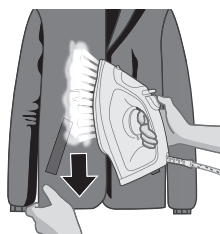

4 Tërhiqni dhe tendosni veshjen ndërsa kryeni përforcimin e avullit për të hequr rrudhat e vështira (vetëm për DST2020 dhe DST2030).



5 Mos përdorni duart tuaja (pa një shtresë mbrojtëse) si sipërfaqe mbështetëse gjatë hekurosjes.

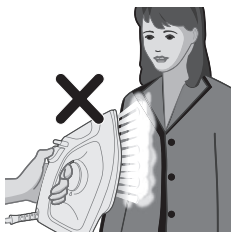

6 Mos e poziciononi pajisjen drejt vetes/dikujt tjetër.

## Fikja automatike (DST2030)

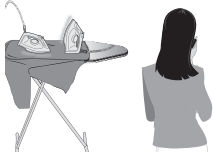

- 1** Për ta pasur mendjen e qetë, pajisja do të ftohet vetë nëse lihet pa mbikëqyrje për njëfarë kohe.

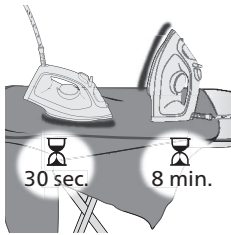

- 2** Kur pajisja nuk përdoret për më shumë se 30 sekonda pas vendosjes në pllakën e saj ose pas 8 minutash pasi mbështetet në pjesën fundore/bazamentin e saj, pajisja do të hyjë në modalitetin e fikjes automatike.

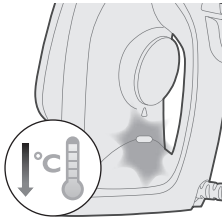

- 3** Temperatura e pajisjes do të ulet në modalitetin e fikjes automatike. Drita që tregon se hekuri është gati gjithashtu do të pulsojë vazhdimisht për të treguar se pajisja është në statusin e fikjes automatike. Për ta fikur plotësisht pajisjen, hiqeni nga priza.

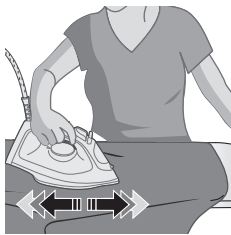

- 4** Për ta lënë pajisjen të ringrohet, ngrijeni ose lëvizeni lehtë.

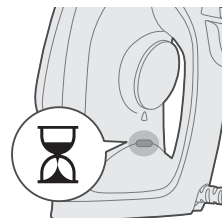

- 5** Drita e avullit gati në hekur do të ndizet duke treguar se pajisja po nxehet.

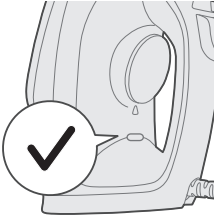

6 Sapo të fiket drita e hekurit gati, pajisja është gati për t'u përdorur.

## Pastrimi dhe mirëmbajtja

1 Sigurohuni që pajisja nuk është në prizë.

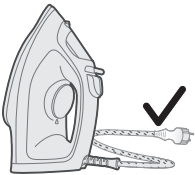
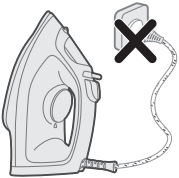

2 Sigurohuni që pajisja është ftohur.

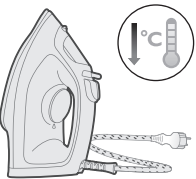

3 Fshini cifat dhe depozitimet e tjera të mundshme nga pllaka e poshtme me një leckë të njomë.







Shënim: Për ta mbajtur pllakën e poshtme të lëmuar, evitoni kontaktin e fortë me sende metalike. Mos përdorni kurrë tel, uthull apo kimikate të tjera për pastrimin e pllakës së poshtme.



- 4 Mos e lani/pastroni pajisjen nën ujë të rrjedhshëm.

## Calc-Clean



Këshillë: Funkzioni Quick Calc Release mund të përdoret në çdo kohë. Nëse banoni në zonë me ujë të rëndë, përdoreni më shpesh si funksion.

- 1 Pas 1 muaji përdorim, rekomandohet që të bëhet pastrimi i çmërsit për të hequr çmërsin e mbledhur nga pajisja juaj, në mënyrë që të zgjatet jetëgjatësia e saj dhe për t'u siguruar që pajisja të nxehet.

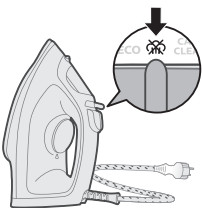

- 2 Sigurohuni që hekuri të jetë shkëputur nga priza dhe cilësimi i avullit të jetë vendosur në modalitetin pa avull (hekurosje në të thatë)

## 346 Shqip

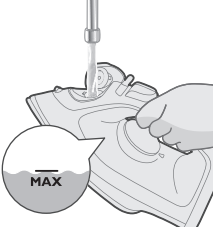

3 Mbushni depozitën e ujit deri në treguesin MAX.



4 Vendosni çelësin rrotullues të temperaturës në MAX.

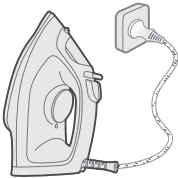

5 Lidhni pajisjen me një prizë të tokëzuar.

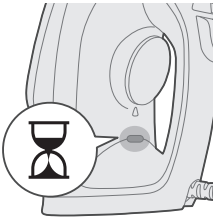

6 Drita e avullit gati në hekur do të ndizet duke treguar se pajisja po nxehet.

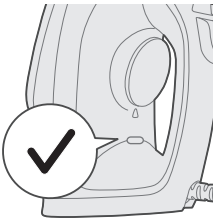

7 Prisni që të fiket llamba që tregon se hekuri është gati.

**8** Hiqni hekurin nga priza.

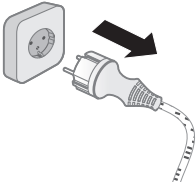

**9** Kalojeni zgjedhësin e avullit në pozicionin Calc-Clean dhe mbajeni aty.

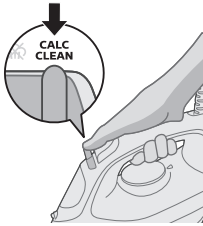

**10** Mbajeni hekurin mbi lavaman dhe tundeni atë lehtësisht. Nga pllaka e poshtme do të dalë ujë i nxehtë dhe grimca çmërsi.



Kujdes: Me nxjerrjen çmërsit, nga pllaka e poshtme mund të dalë edhe avull dhe ujë i vluar.

**11** Vazhdoni ta tundni hekurin derisa të zbrazet i gjithë uji i depozitës.

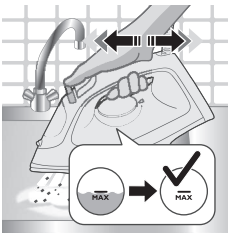

**12** Futeni pajisjen në prizë dhe lëreni të ngrohet për të tharë pllakën e poshtme. Kjo mund të kërkojë rreth 2 minuta.

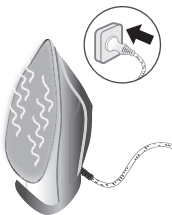

## 348 Shqip

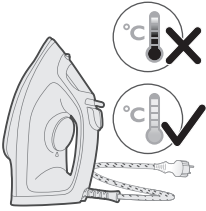

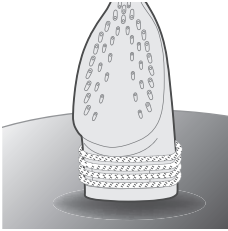

13 Lëreni hekurin të ftohet.

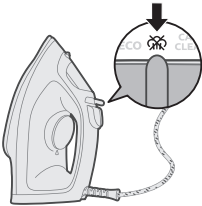

14 Mblidheni kordonin përreth pjesës fundore të hekurit.

## Vendruajtja



1 Rrëshqitni përzgjedhësin e avullit për të zgjedhur modalitetin pa avull (hekurosje në të thatë) .

2 Hiqeni pajisje nga priza.

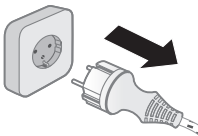

3 Lëreni pajisjen të ftohet.

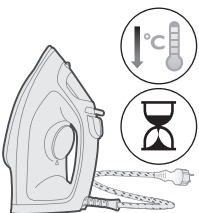

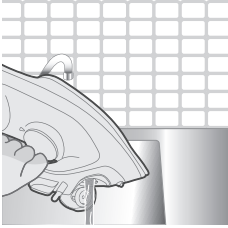

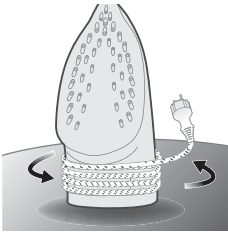

4 Derdhni ujin e mbetur nga depozita e ujit.





5 Mblidheni kordonin elektrik përreth trupit të pajisjes.

## Diagnostikimi

Ky kapitull përmbledh problemet më të shpeshta që mund të hasni me pajisjen. Nëse nuk keni mundësi ta zgjidhni problemin me informacionin e mëposhtëm, vizitoni [www.philips.com/support](http://www.philips.com/support) për një listë të pyetjeve të shpeshta ose kontaktoni me qendrën e shërbimit të klientit për shtetin tuaj.

Problemi	Shkaku i mundshëm	Zgjidhja
Hekuri nuk mund t'i heqë rrudhat nga rroba.	Nuk ka avull gjatë hekurosjes.	Mbusheni depozitën dhe caktojini niveluesin e avullit në  .
Hekuri nuk prodhon avull.	Nuk ka ujë të mjaftueshëm në depozitë.	Mbushni depozitën e ujit.
	Niveluesi i avullit është caktuar në  .	Caktojini niveluesin e avullit në  .
	Hekuri nuk është ngrohur mjaftueshëm për të nxjerrë avull.	Kur hekuri ngrohet, drita "hekuri gati" qëndron ndezur. Kur hekuri është gati për përdorim, drita fiket.
Bien pika uji mbi rroba gjatë hekurosjes.	E keni përdorur shpesh funksionin e përforcimit të avullit brenda një kohe të shkurtër.	Vazhdoni hekurosjen në pozicionin horizontal dhe prisni ca përpara se të përdorni sërish funksionin e përforcimit të avullit.
	Nuk e keni mbyllur siç duhet kapakun e depozitës së ujit.	Shtyjini kapakun derisa të dëgjoni "klik".

## 350 Shqip

Hekuri nuk prodhon përforcim avulli.	E keni përdorur shpesh funksionin e përforcimit të avullit brenda një periudhe të shkurtër.	Vazhdoni hekurosjen në pozicionin horizontal dhe prisni ca përpara se të përdorni sërish funksionin e përforcimit të avullit.
	Hekuri nuk është ngrohur ende mjaftueshëm për hekurosje.	Prisni derisa drita "hekuri gati" të pushojë së pulsuari dhe të qëndrojë ndezur.
	Keni hedhur kimikat në depozitën e ujit.	Shpëljajeni depozitën e ujit dhe mos hidhni parfum apo kimikate në të.
Pikon ujë nga pllaka pas heqjes së hekurit nga priza.	Niveluesi i avullit është caktuar në  .	Caktojini niveluesin e avullit në  .
	E keni vendosur hekurin në pozicion horizontal duke e lënë me ujë në depozitë.	Zbrazeni depozitën pas përdorimit ose vendoseni hekurin në pozicionin vertikal.
Hekuri lë një shkëlqim ose një gjurmë në rrobë.	Sipërfaqja e hekurosjes nuk ishte e drejtë, pasi për shembull keni qenë duke hekurosuar mbi ndonjë tegel apo palë të rrobës.	Hekuri mund të përdoret në mënyrë të sigurt në të gjitha rrobat e hekuroshme. Shkëlqimi ose vija e hekurit nuk janë të përhershme dhe ikin nëse lani rrobën. Evitoni hekurosjen mbi tegela apo pala. Mund dhe të vendosni një pëlhurë pambuku mbi zonën e hekurosjes për të shmangur gjurmët e hekurit.

## Uvod

Čestitamo vam za nakup in dobrodošli pri Philipsu! Da bi v celoti izkoristili vse prednosti Philipsove podpore, izdelek registrirajte na [www.philips.com/welcome](http://www.philips.com/welcome). Pred uporabo aparata natančno preberite ta uporabniški priročnik, letak s pomembnimi informacijami in vodnik za hiter začetek. Shranite jih za poznejšo uporabo.

## Pregled izdelka

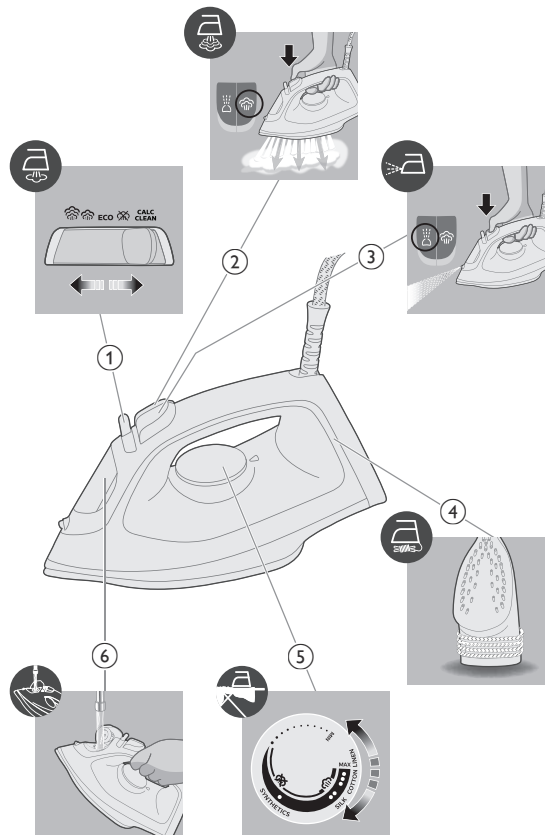

- 1 Izbirnik za nastavitev pare
- 2 Gumb za izpust pare
- 3 Razpršilnik vode
- 4 Del za navijanje kabla
- 5 Temperaturni regulator
- 6 Pokrov posode za vodo

## Uporaba aparata

### Priprava pred uporabo

Opomba: pri prvi uporabi se lahko iz likalnika odvede nekaj pare. Ta pojav čez nekaj časa izgine.

#### Vrsta vode, ki jo morate uporabiti

Aparat je primeren za uporabo z vodo iz pipe. Če živite na območju s trdo vodo, vam priporočamo, da zmešate enako količino vode iz pipe in destilirane ali demineralizirane vode. S tem preprečite hitro nabiranje vodnega kamna in podaljšate življenjsko dobo aparata.

**Ne dodajajte dišav, vode iz sušilnika, kisa, škroba, sredstev za odstranjevanje vodnega kamna, dodatkov za likanje, kemično omeščane vode ali drugih kemikalij, ker to lahko povzroči uhajanje vode, pojav rjavih madežev ali poškodbo aparata.**

### Polnjenje posode za vodo

- 1 Aparata priklopljajte v električno vtičnico.

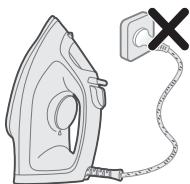

- 2 Počakajte, da se aparat ohladi.

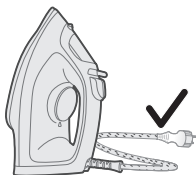



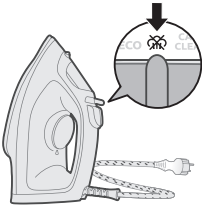

- 3 Potisnite izbirnik za nastavitve pare v desno, da izberete način brez pare (suho likanje) .



- 4 Odprite pokrov posode za vodo.

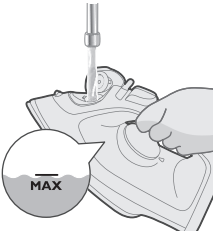

- 5 Posodo za vodo napolnite do oznake MAX v njej.

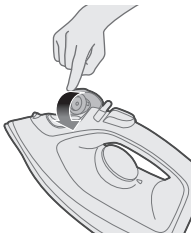

- 6 Trdno zaprite pokrov posode za vodo.

## Nastavitev temperature



MAX (Največ)  
LINEN (Lan)



● ● ●  
COTTON (Bombaž)





SILK (Svila)

**ECO**

SYNTHETICS (Sintetika)

**ECO**

Nastavitev ECO: neprekinjeno dovajanje najmanjše količine pare za oblačila z manj gubami. S to nastavitvijo varčujete tudi z energijo.



Dva oblačka pare: neprekinjeno dovajanje večje količine pare za trdovratne gube.



Trije oblački pare: neprekinjeno dovajanje največje količine pare za trdovratne gube.

## Uporaba aparata

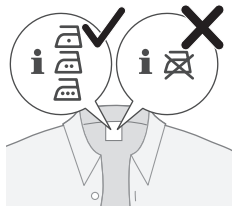

1 Na etiketi oblačila preverite, kako je oblačilo treba likati.

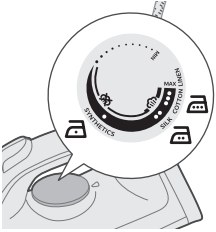

- 2 Nastavite temperaturni regulator na želeno temperaturo likanja tako, da ga obrnete na ustrezno oznako temperature.

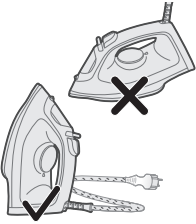

- 3 Likalnik postavite na ploščati zadnji del.

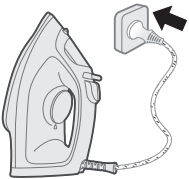

- 4 Aparat priklopite v ozemljeno vtičnico.

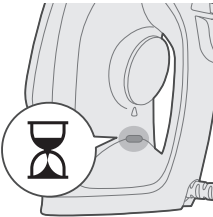

- 5 Svetiti bo začel indikator pripravljenosti likalnika, ki označuje, da se likalnik segreva.

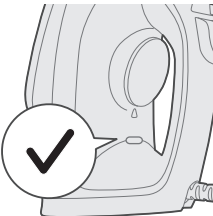

- 6 Ko se indikator pripravljenosti likalnika izklopi, počakajte nekaj časa, preden začnete likati. Indikator pripravljenosti se med likanjem občasno vklopi.

## Likanje brez pare/suho likanje

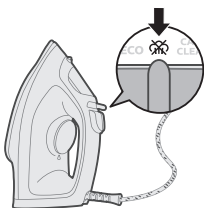

- 1 Paro nastavite na nastavev brez pare.

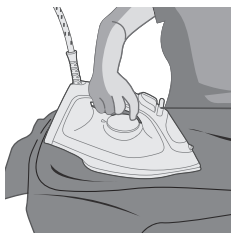

- 2 Kmalu se bo med likanjem nehala odvajati para.

## Razpršilnik vode

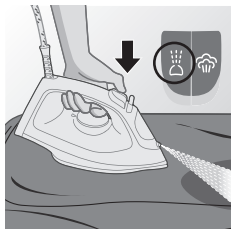

- 1 Paro nastavite na nastavev brez pare. Pritisnite in sprostite gumb za pršenje vode, da likalnik sprosti curek meglíce za odstranjevanje trdovratnih gub.

## Izpust pare

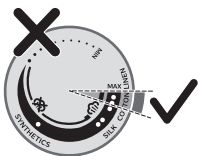

- 1 Nastavite temperaturni regulator na nastavev MAX med bombažem in lanom.

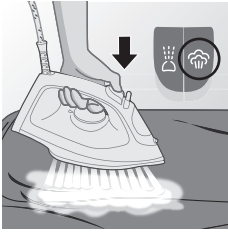

2 Pritisnite in sprostite gumb za izpust pare, da likalnik sprosti močan izpust pare za odstranjevanje trdovratnih gub.

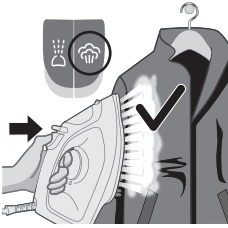

3 Funkcijo za izpust pare lahko uporabljate tudi, ko likalnik držite v navpičnem položaju pri likanju visečih oblačil (samo DST2020 in DST2030).

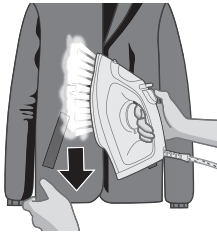

4 Za odstranjevanje trdovratnih gub med uporabo izpusta pare oblačilo raztegnite (samo DST2020 in DST2030).



5 Pri likanju za oporo ne uporabljajte gole roke.

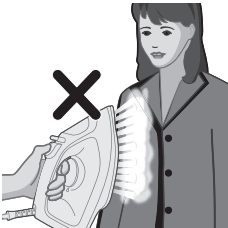

6 Aparata ne usmerjajte vase ali v drugo osebo.

## Funkcija samodejnega izklopa (DST2030)

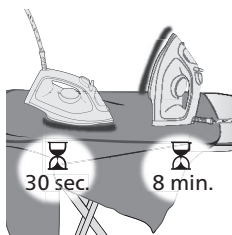

**1** Če aparat določen čas pustite brez nadzora, se samodejno ohladi, tako da ste lahko povsem brez skrbi.

**2** Če aparata ne uporabljate več kot 30 sekund, ko je na likalni plošči, ali 8 minut, ko je pokonci na svojem ploščatem zadnjem delu, se preklopi v način samodejnega izklopa.

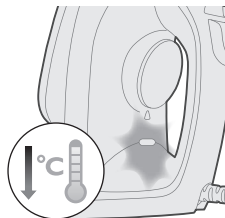

**3** V načinu samodejnega izklopa se zniža temperatura aparata. Poleg tega neprekinjeno utripa indikator pripravljenosti likalnika, kar pomeni, da je aparat v stanju samodejnega izklopa. Za popoln izklop aparata aparat izklopite iz električne vtičnice.

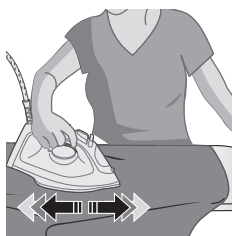

**4** Da se aparat ponovno segreje, ga dvignite ali malce premaknite.

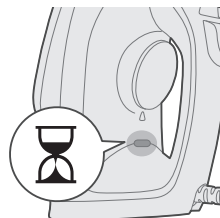

**5** Svetiti bo začel indikator pripravljenosti likalnika, ki označuje, da se aparat segreva.

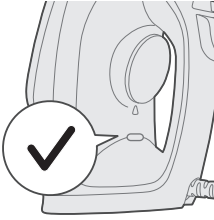

- 6 Ko se indikator pripravljenosti likalnika izklopi, je aparat pripravljen za uporabo.

## Čiščenje in vzdrževanje

- 1 Zagotovite, da aparat ni priključen v električno omrežje.

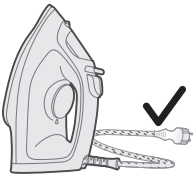
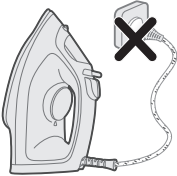

- 2 Zagotovite, da se je aparat ohladil.

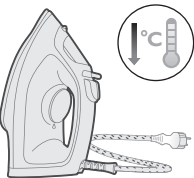

- 3 Z vlažno krpo z likalne plošče obrišite delce in druge usedline.



Opomba: da ohranite likalno ploščo gladko, se izogibajte stiku te s kovinskimi predmeti. Za čiščenje likalne plošče ne uporabljajte grobih čistilnih gobic, kisa ali drugih kemikalij.

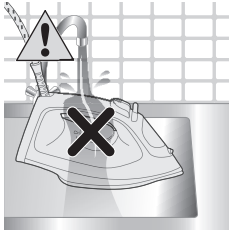

4 Aparata ne čistite pod tekočo vodo.

## Odstranjevanje vodnega kamna

Namig: funkcijo za hitro odstranjevanje vodnega kamna lahko uporabite kadarkoli. Če živite na območju s trdo vodo, funkcijo uporabite pogosteje.



1 Priporočamo, da po enem mesecu uporabe odstranite vodni kamen, ki se je nabral v aparatu, s čimer zagotovite, da se bo aparat lahko segrel, in podaljšate njegovo življenjsko dobo.

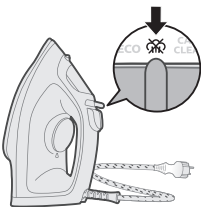

2 Prepričajte se, da je likalnik izključen iz električnega omrežja in nastavev pare nastavljena na način brez pare (suho likanje) .



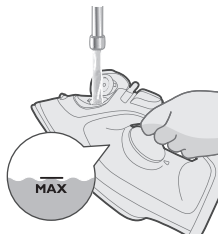

3 Posodo za vodo napolnite do oznake MAX.

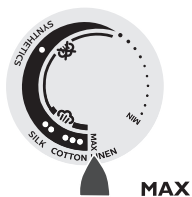

4 Temperaturni regulator nastavite na MAX.

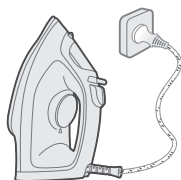

5 Aparat priključite v ozemljeno stensko vtičnico.

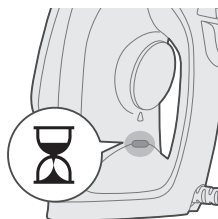

6 Svetiti bo začel indikator pripravljenosti likalnika, ki označuje, da se aparat segreva.

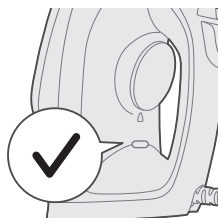

7 Počakajte, da se indikator pripravljenosti likalnika izklopi.

8 Likalnik izključite iz električnega omrežja.

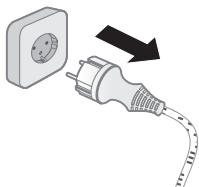

9 Izbirnik za nastavev pare potisnite v položaj za odstranjevanje vodnega kamna in ga pridržite.

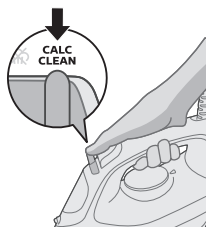

10 Likalnik pridržite nad pomivalnim koritom in ga nežno stresajte. Iz likalne plošče bodo odvedeni delci vodnega kamna in vroča voda.



Pozor: ko izteka vodni kamen, iz likalne plošče uhajata tudi para in vroča voda.

11 Likalnik stresajte, dokler ne izpustite vse vode iz posode za vodo.

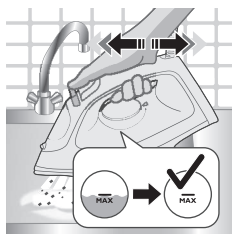

12 Aparat priključite v električno omrežje in počakajte, da se segreje in s tem posuši likalno ploščo. To traja približno 2 minuti.



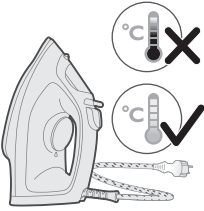

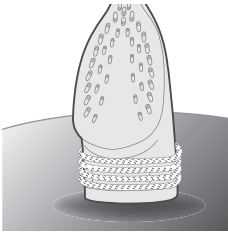

**13** Pustite likalnik, da se ohladi.

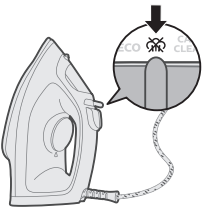

**14** Kabel navijte okoli ploščatega zadnjega dela likalnika.

## Shranjevanje



**1** Potisnite izbirnik za nastavitve pare tako, da izberete način brez pare (suho likanje) .

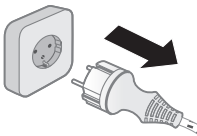

**2** Aparat izključite iz električnega omrežja.

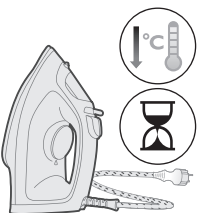

**3** Pustite aparat, da se ohladi.

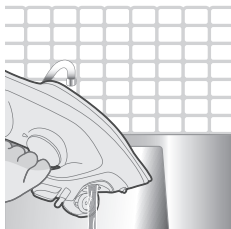

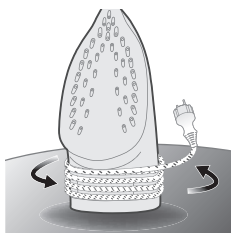

4 Iz posode za vodo izlijte preostalo vodo.





5 Napajalni kabel navijte okoli ohišja aparata.

## Odpravljanje težav

To poglavje vsebuje povzetek najpogostejših težav, ki se lahko pojavijo pri uporabi aparata. Če težav s temi nasveti ne morete odpraviti, na strani [www.philips.com/support](http://www.philips.com/support) poiščite seznam pogostih vprašanj ali se obrnite na center za pomoč uporabnikom v svoji državi.

Težava	Možni vzrok	Rešitev
Likalnik ne more odstraniti gub z oblačil.	Med likanjem ni pare.	Napolnite posodo za vodo in drsnik za paro nastavite na  .
Likalnik ne ustvarja pare.	V posodi ni dovolj vode.	Napolnite posodo za vodo.
	Drsnik za paro je nastavljen na  .	Drsnik za paro nastavite na  .
	Likalnik ni dovolj segret, da bi lahko ustvarjal paro.	Ko se likalnik segreva, indikator pripravljenosti likalnika neprekinjeno sveti. Ko je likalnik pripravljen za uporabo, se indikator izklopi.
Vodne kapljice med likanjem kapljajo na oblačilo.	Funkcijo za povečanega izpusta pare ste v kratkem obdobju uporabili prevečkrat.	Nadaljujte z likanjem v vodoravnem položaju in pred ponovno uporabo funkcije za povečan izpust pare nekoliko počakajte.
	Pokrova posode za vodo niste pravilno zaprli.	Pritisnite pokrovček, dokler ne zaslišite klika.

Likalnik ne ustvarja povečanega izpusta pare.	Funkcijo za povečan izpust pare ste v kratkem obdobju uporabili prevečkrat.	Nadaljujte z likanjem v vodoravnem položaju in pred ponovno uporabo funkcije za povečan izpust pare nekoliko počakajte.
	Likalnik še ni dovolj vroč za likanje.	Počakajte, da indikator pripravljenosti likalnika preneha utripati in sveti neprekinjeno.
	V posodo za vodo ste dodali kemikalijo.	Sperite posodo za vodo in vanjo ne dodajajte parfuma ali kemikalij.
Po odklopu napajanja likalnika, skozi likalno ploščo kaplja voda.	Drsnik za paro je nastavljen na  .	Drsnik za paro nastavite na  .
	Likalnik ste postavili v vodoraven položaj, v posodi za vodo pa je še ostalo nekaj vode.	Po uporabi izpraznite posodo za vodo ali likalnik postavite v pokončen položaj.
Po likanju je na oblačilu viden sijaj ali odtis likalnika.	Površina za likanje ni bila ravna, ker ste na primer likali čez šiv ali pregib oblačila.	Z likalnikom lahko varno likate vsa oblačila, ki so primerna za likanje. Sijaj ali odtis ni trajen in bo izginil po pranju oblačila. Ne likajte čez šive ali pregibe. Na površino za likanje lahko tudi položite bombažno krpo in tako preprečite odtise.

# Úvod

Blahoželáme vám ku kúpe a vítame vás medzi používateľmi produktov spoločnosti Philips! Ak chcete naplno využiť podporu ponúkanú spoločnosťou Philips, zaregistrujte svoj produkt na lokalite [www.philips.com/welcome](http://www.philips.com/welcome). Pred použitím zariadenia si prečítajte tento návod na použitie, leták s dôležitými informáciami a stručný návod pri spustení. Odložte si ich na neskoršie použitie. Odložte si ich na neskoršie použitie.

## Prehľad produktu

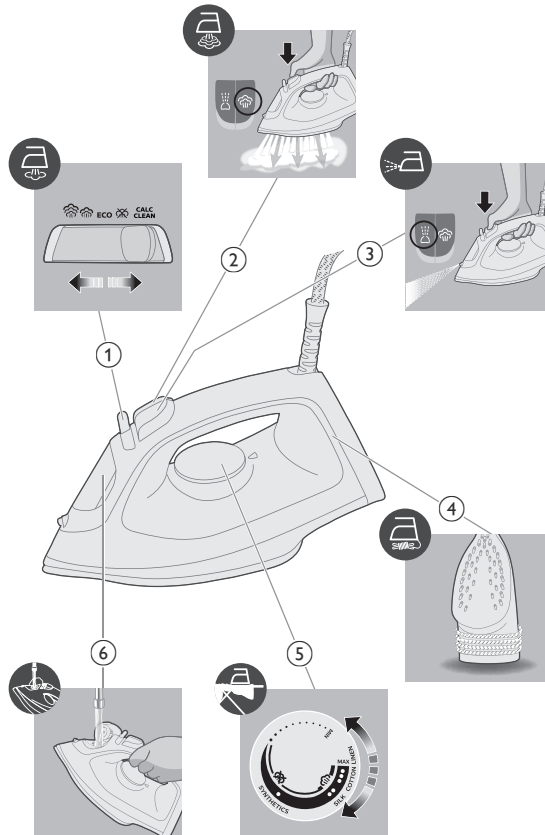

- 1 Regulátor pary
- 2 Tlačidlo parného rázu
- 3 Kropenie vodou
- 4 Navíjanie kábla
- 5 Otočný regulátor teploty
- 6 Veko nádržky na vodu

## Používanie zariadenia

### Príprava na použitie

Poznámka: Počas prvého použitia môže zo žehličky vychádzať para. Po chvíli to však prestane.

#### Typ vody, ktorý sa má používať

Zariadenie je vhodné na použitie s vodou z vodovodu. Ak však žijete v oblasti s tvrdou vodou, odporúčame vám zmiešať vodu z vodovodu s rovnakým množstvom destilovanej alebo demineralizovanej vody. Predídete tak rýchlemu usadzovaniu vodného kameňa a predĺžite životnosť zariadenia.

**Nepridávajte parfum, vodu zo sušičky, ocot, škrob, prostriedky na odstránenie vodného kameňa, prostriedky na uľahčenie žehlenia, chemicky zmäkčenú vodu ani žiadne iné chemické látky, pretože môžu spôsobiť prskanie vody, hnedé sfarbenie alebo poškodenie spotrebiča.**

### Plnenie zásobníka na vodu

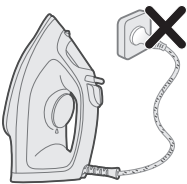

- 1 Nepripájajte zariadenie do siete.

2 Uistite sa, že zariadenie vychladlo.

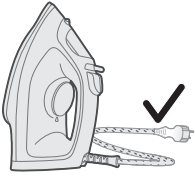

3 Posunutím regulátora pary doprava vyberte režim bez naparovania (suché žehlenie) ~~☑~~.

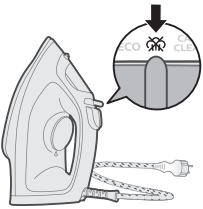

4 Otvorte veko zásobníka na vodu.

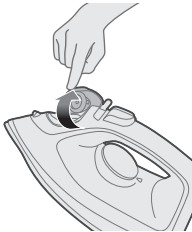

5 Zásobník na vodu naplňte po značku MAX.

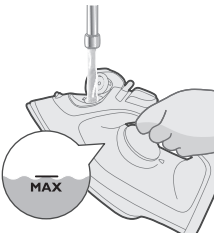

6 Veko zásobníka na vodu pevne zatvorte.

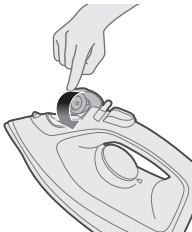



## Nastavenie teploty



	MAX LINEN	
	● ● ● COTTON	
	● ● SILK	<b>ECO</b>
	● SYNTHETICS	

ECO



Nastavenie ECO: Nepretržite sa produkuje minimálna konštantná para pre menej pokrčené odevy. Toto nastavenie tiež šetrí energiu.

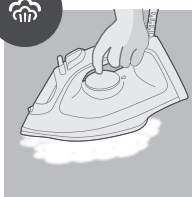

Dva oblaky pary: Nepretržite sa produkuje viac konštantnej pary pre odolné záhyby.



Tri oblaky pary: Nepretržite sa produkuje maximálna konštantná para pre nepoddajné záhyby.

## Používanie zariadenia

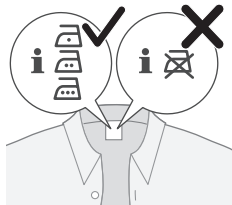

1 Požadované žehlenie si pozrite na štítku na odevu.

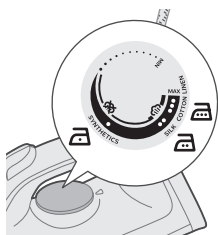

2 Požadovanú teplotu žehlenia nastavte otočením regulátora teploty na príslušný ukazovateľ teploty.

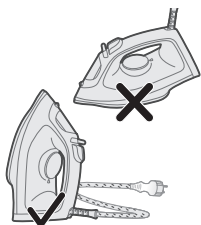

3 Počas nečinnosti postavte žehličku na pätu.

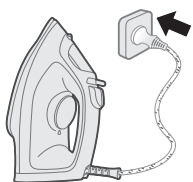

4 Zariadenie zapojte do uzemnenej sieťovej zásuvky.

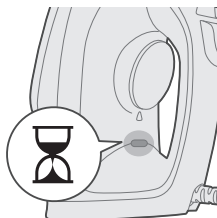

5 Rozsvieti sa kontrolka pripravenosti žehličky, ktorá signalizuje, že sa žehlička zahrieva.

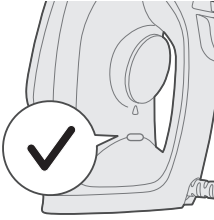

- 6 Keď kontrolka pripravenosti žehličky zhasne, pred začatím žehlenia chvíľu počkajte. Kontrolka pripravenosti sa počas žehlenia z času na čas rozsvieti.

## Žehlenie bez napařovania/suché žehlenie

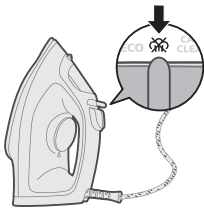

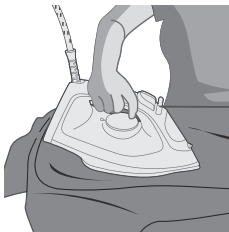

- 1 Napařovanie nastavte na možnosť žehlenia bez napařovania.

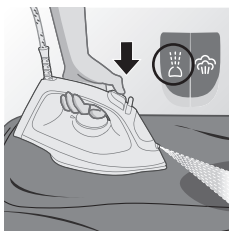

- 2 Počas žehlenia sa po chvíli para prestane produkovať.

## Kroplenie vodou



- 1 Napařovanie nastavte na možnosť žehlenia bez napařovania. Stlačením a uvoľnením tlačidla na kroplenie vodou  vypustíte prúd vodnej hmly, ktorý odstráni aj nepoddajné záhyby.

## Funkcia prídavného prúdu pary

- 1 Nastavte otočný regulátor teploty na hodnotu MAX medzi bavlnu a ľan.

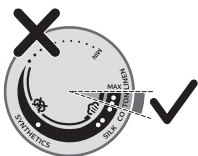

- 2 Stlačením a uvoľnením tlačidla parného rázu sa vytvorí silný prúd pary na odstránenie nepoddajných záhybov.



- 3 Funkciu parného rázu môžete použiť na vyžehlenie záhybov na zavesených odevoch, keď držíte žehličku vo zvislej polohe (len pre modely DST2020 a DST2030).

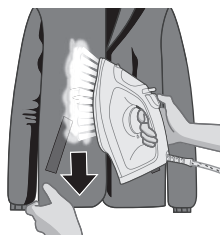

- 4 Pri používaní parného rázu odev natahujte a vystierajte s cieľom odstrániť nepoddajné záhyby (len pre modely DST2020 a DST2030).



- 5 Pri žehlení nepoužívajte ako opornú plochu holú ruku.

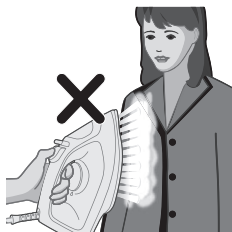

6 Zariadenie nesmerujte k sebe/inej osobe.

## Režim automatického vypnutia (DST2030)

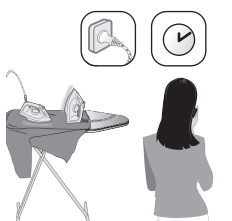

1 Pre váš pocit istoty sa zariadenie samostatne ochladí, ak ho necháte určitý čas v nečinnosti.

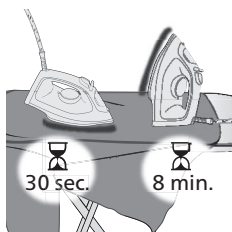

2 Ak zariadenie nepoužívate dlhšie ako 30 sekúnd, v nečinnosti na žehliacej ploche alebo 8 minút v nečinnosti na päte/základni, prepne sa do režimu automatického vypnutia.

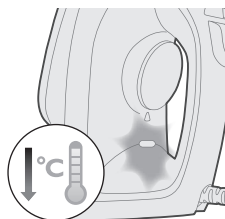

3 Teplota zariadenia sa v režime automatického vypnutia zníži. Kontrolka pripravenosti žehličky tiež nepretržite bliká, čo znamená, že zariadenie je v stave automatického vypnutia. Na celkové vypnutie spotrebiča ho odpojte zo zásuvky.

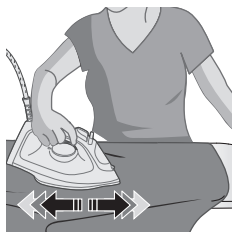

4 Ak chcete zariadenie znova zahriať, zdvihnite ho alebo ním jemne pohnite.

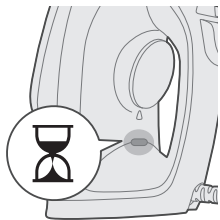

5 Rozsvieti sa kontrolka pripravenosti žehličky, ktorá signalizuje, že sa zariadenie zahrieva.

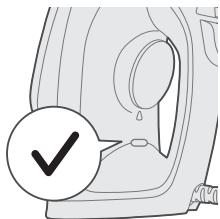

6 Keď sa kontrolka pripravenosti žehličky vypne, zariadenie je pripravené na použitie.

## Čistenie a údržba

1 Uistite sa, že zariadenie nie je zapojené do siete.

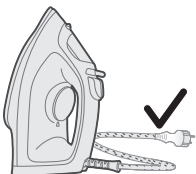
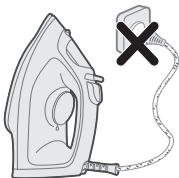

2 Uistite sa, že je zariadenie vychladnuté.

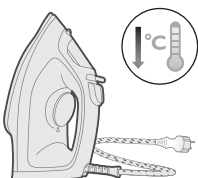

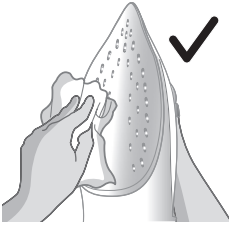

- 3 Navlhčenou tkaninou utrite šupiny a iné usadeniny zo žehliacej plochy.



Poznámka: Aby bola žehliaca plocha hladká, vyhýbajte sa prudkému kontaktu s kovovými predmetmi. Na čistenie žehliacej plochy nikdy nepoužívajte drôtenku, ocot ani iné chemikálie.



- 4 Zariadenie neumývajte/nečistite pod tečúcou vodou.

## Odstraňovanie vodného kameňa

Tip: Funkciu rýchleho uvoľnenia vodného kameňa Quick Calc Release môžete použiť kedykoľvek. Ak žijete v oblasti s tvrdou vodou, funkciu používajte častejšie.

- 1 Po 1 mesiaci používania sa odporúča odstrániť vodný kameň, aby sa odstránili šupiny nahromadené v zariadení, aby sa predĺžila jeho životnosť a aby sa zaistilo, že sa zariadenie zahreje.



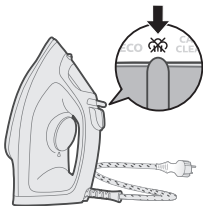

2 Uistite sa, že je žehlička odpojená zo siete a naparovanie je nastavené na režim bez naparovania (suché žehlenie) .

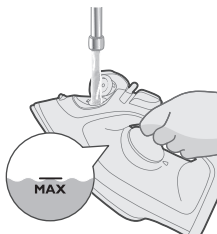

3 Zásobník na vodu naplňte po značku MAX.

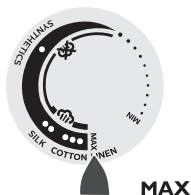

4 Otočný regulátor teploty nastavte na značku MAX.

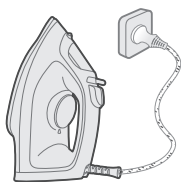

5 Zariadenie zapojte do uzemnenej zásuvky.

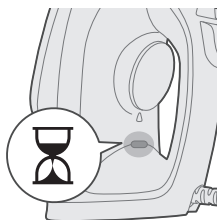

6 Rozsvietí sa kontrolka pripravenosti žehličky, ktorá signalizuje, že sa zariadenie zahrieva.



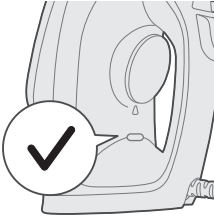

**7** Počkajte, kým kontrolka pripravenosti zhasne.

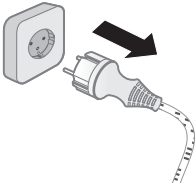

**8** Žehličku odpojte zo siete.

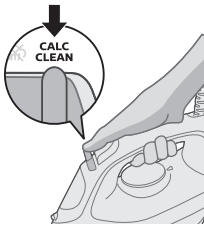

**9** Posuňte regulátor pary do polohy Calc-Clean a podržte ho.



**10** Žehličku podržte nad umývadlom a jemne ňou potraсте. Zo žehliacej plochy sa uvoľní horúca voda a čiastočky vodného kameňa.

Upozornenie: Pri vyplachovaní vodného kameňa zo žehliacej plochy vyjde aj para a vriaca voda.

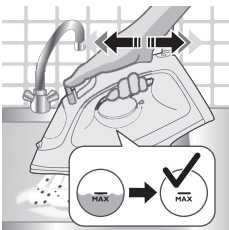

**11** Žehličkou naďalej potriasajte, kým sa neuvolní všetka voda v zásobníku na vodu.

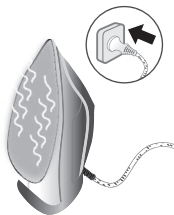

**12** Pripojte zariadenie do siete a nechajte ho zahriať, aby sa vysušila žehliaca plocha. Tento proces trvá približne 2 minúty.

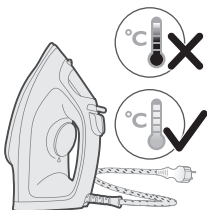

**13** Žehličku nechajte vychladnúť.

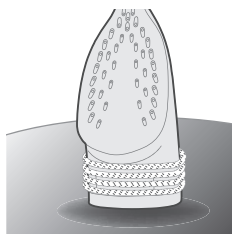

**14** Kábel naviňte okolo päty žehličky.

## Odkladanie

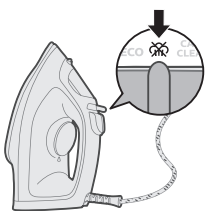

**1** Posunutím regulátora pary vyberte režim bez naparovania (suché žehlenie) ~~ON~~.

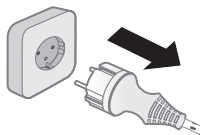

**2** Spotrebič odpojte zo zásuvky.

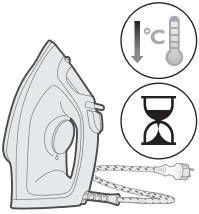

3 Zariadenie nechajte vychladnúť.

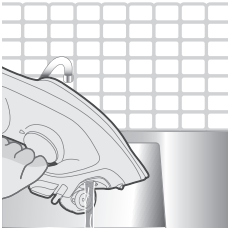

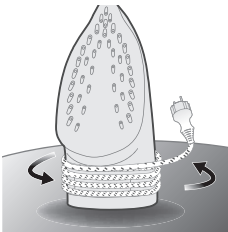

4 Zo zásobníka na vodu vylejte zvyšnú vodu.



5 Napájací kábel navíňte okolo tela zariadenia.

## Riešenie problémov

Táto kapitola uvádza najbežnejšie problémy, s ktorými by ste sa pri používaní spotrebiča mohli stretnúť. Ak neviete problém vyriešiť pomocou nižšie uvedených informácií, navštívte webovú stránku [www.philips.com/support](http://www.philips.com/support), na ktorej nájdete zoznam často kladených otázok, alebo sa obráťte na Stredisko starostlivosti o zákazníkov vo svojej krajine.

Problém	Možná příčina	Riešenie
Žehlička z odevov neodstraňuje záhyby.	Počas žehlenia sa netvorí žiadna para.	Naplňte zásobník na vodu a posuňte posuvný spínač pary do polohy  .
Žehlička neuvolňuje žiadnu paru.	V zásobníku nie je žiadna voda.	Naplňte zásobník na vodu.
	Posuvný spínač pary je nastavený v polohe  .	Nastavte posuvný spínač pary do polohy  .

	Žehlička nie je dostatočne horúca, aby vytvorila paru.	Keď sa žehlička nahrieva, svetlo „žehlička pripravená“ svieti neprerušovane. Keď svetlo zhasne, žehlička je pripravená na použitie.
Počas žehlenia kvapká na odevy voda.	V krátkom čase ste používali funkciu rázu príliš často.	Žehlite naďalej v horizontálnej polohe a pred opätovným použitím funkcie parného rázu chvíľu počkajte.
	Nezavreli ste veko nádrčky na vodu správne.	Zatlačte veko až kým nebudete počuť „klik“.
Žehlička neprodukuje zosilnenú paru.	V krátkom čase ste používali funkciu parného rázu príliš často.	Žehlite naďalej v horizontálnej polohe a pred opätovným použitím funkcie parného rázu chvíľu počkajte.
	Žehlička sa ešte dosť nenahriala.	Počkajte, kým svetlo „žehlička je pripravená“ prestane blikať a svieti neprerušovane.
	Dali ste do nádoby na vodu chemikálie.	Vypláchnite nádobu na vodu a nelejte do nej žiadne parfumy alebo chemikálie.
Po odpojení žehličky zo zásuvky sa na žehliacej ploche objavili kvapky vody.	Posuvný spínač pary je nastavený na  .	Nastavte posuvný spínač pary na  .
	Postavili ste žehličku do horizontálnej polohy, keď v nádobe na vodu bola ešte voda.	Vyprázdnite nádobu na vodu alebo uskladňujte žehličku vo vertikálnej polohe.
Žehlička zanecháva na odevu lesklé plochy alebo iné stopy.	Povrch, ktorý ste žehlili, nebol rovný, pretože ste napríklad žehlili švy alebo záhyby odevu.	Žehličku môžete používať na všetkých odevoch, ktoré sa môžu žehliť. Lesk a stopy po žehlení nie sú trvalé a zmiznú po vypratí odevu. Nežehlite švy a záhyby. Aby ste sa vyhli odtlačkom, položte na oblasť, ktorú idete žehliť bavlnenú handričku.

# Uvod

Čestitamo na kupovini i dobro došli u Philips! Da biste na najbolji način iskoristili podršku koju nudi kompanija Philips, registrujte proizvod na [www.philips.com/welcome](http://www.philips.com/welcome). Pažljivo pročitajte ovaj korisnički priručnik, brošuru sa važnim informacijama i vodič za brzi početak pre upotrebe aparata. Sačuvajte ih kao referencu za ubuduće.

## Pregled proizvoda

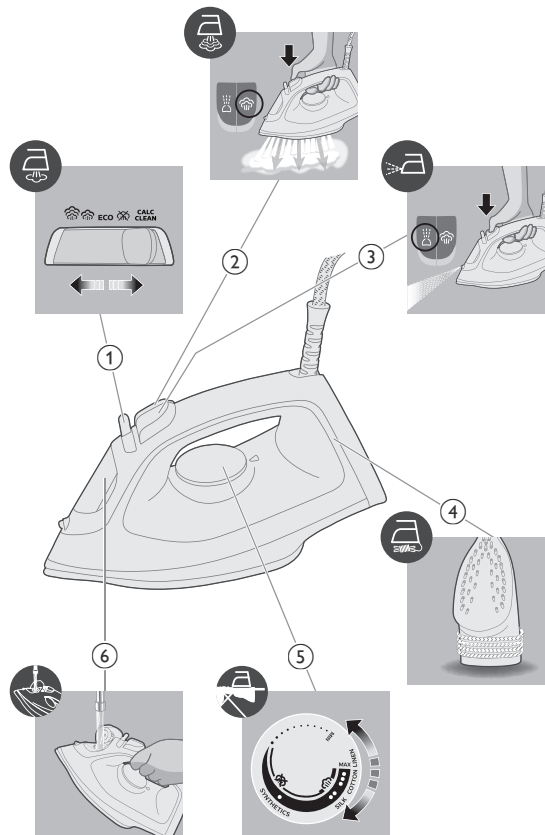

- 1 Birač postavke pare
- 2 Dugme za dodatnu količinu pare
- 3 Prskalica
- 4 Namotavanje kabla
- 5 Regulator temperature
- 6 Poklopac posude za vodu

## Upotreba aparata

### Pre upotrebe

Napomena: Pri prvoj upotrebi, pegla može da izbaci malo pare. To će ubrzo prestati.

#### Tip vode koji bi trebalo koristiti

Ovaj aparat je prikladan za korišćenje sa vodom iz česme. Međutim, ako živite u oblasti sa tvrdom vodom, preporučujemo da pomešate jednake količine vode sa česme i destilovane ili demineralizovane vode. To će sprečiti brzo stvaranje naslaga kamenca i produžiti radni vek aparata.

**Nemojte da dodajete parfem, vodu iz mašine za sušenje veša, sirće, štirak, sredstva za uklanjanje kamenca, aditive za peglanje, vodu čiji je sadržaj kamenca smanjen hemijskim putem niti druge hemikalije zato što to može da dovede do prskanja vode, pojave braon fleka ili oštećenja aparata.**

### Punjenje rezervoara za vodu

- 1 Nemojte da priključujete aparat.

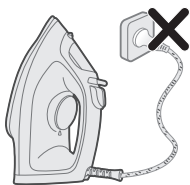

2 Uverite se da se aparat ohladio.

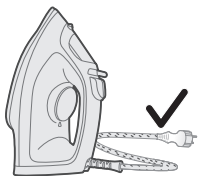

3 Pomerite birač postavke pare udesno da biste izabrali režim bez pare (suvo peglanje) ~~☒~~.

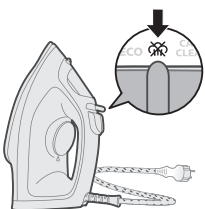

4 Otvorite poklopac rezervoara za vodu.

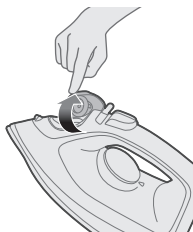

5 Napunite rezervoar vodom do oznake MAX.

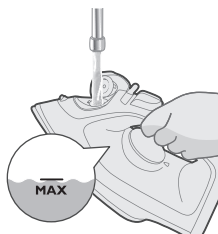

6 Čvrsto zatvorite poklopac rezervoara za vodu.

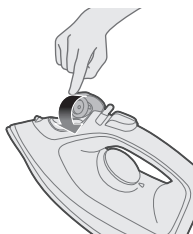

## Podlašavanje temperature



	MAKS LAN	
	● ● ● PAMUK	
	● ● SVILA	<b>ECO</b>
	● SINTETIKA	

ECO



Postavka ECO: Uzastopno se primenjuje minimalna količina pare, za odevne predmete sa manje nabora. Ova postavka takode štedi energiju.



Dva oblaka pare: Uzastopno se primenjuje veća količina pare, za tvrdokorne nabore.



Tri oblaka pare: Uzastopno se primenjuje maksimalna količina pare, za nabore koji se teško uklanjaju.



## Upotreba aparata



- 1 Pogledajte etiketu na odevnom predmetu i proverite odgovarajuću temperaturu peglanja.

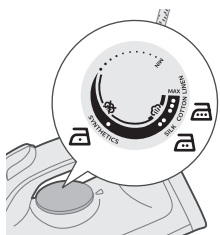

- 2 Podesite regulator temperature okrećući ga prema odgovarajućoj oznaci za temperaturu.

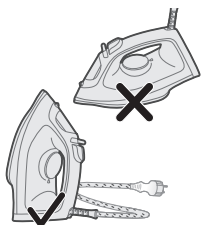

- 3 Postavite peglu u uspravan položaj.

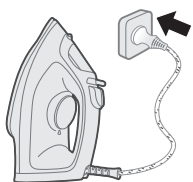

- 4 Uključite aparat u uzemljenu zidnu utičnicu.

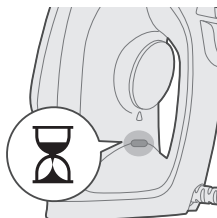

- 5 Indikator „Pegla je spremna“ će se uključiti, što ukazuje na to da se pegla zagreva.

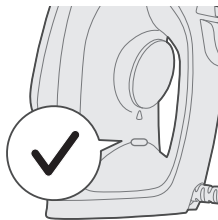

- 6 Kada se indikator „Pegla je spremna“ isključi, sačekajte malo pre nego što počnete da peglate. Indikator spremnosti će se tokom peglanja povremeno uključivati.

## Bez pare / Suvo peglanje

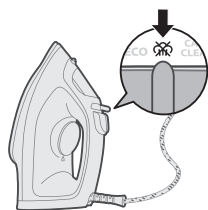

- 1 Podesite regulator pare na režim bez pare.

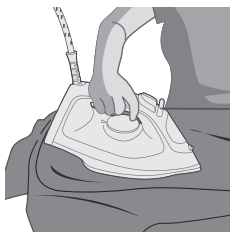

- 2 Nakon kratkog vremena para će prestati da izlazi tokom peglanja.

## Prskalica



- 1 Podesite regulator pare na režim bez pare. Pritisnite i otpustite dugme prskalice ☁ za mlaz sitnih kapljica za uklanjanje upornih nabora.

## Dodatna količina pare

- 1 Podesite regulator temperature na postavku MAKS, između pamuka i lana.

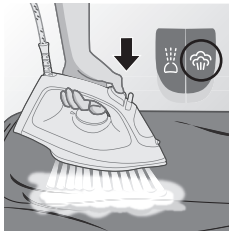
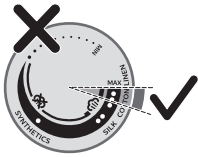

- 2 Pritisnite i otpustite dugme za mlaz pare da biste dobili snažan mlaz pare i uklonili veće nabore.

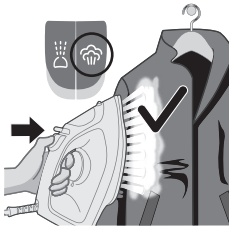

- 3 Funkciju dodatne količine pare možete da koristite i dok peglu držite u vertikalnom položaju da biste uklonili nabore sa odevnih predmeta koji vise (samo za DST2020 i DST2030).

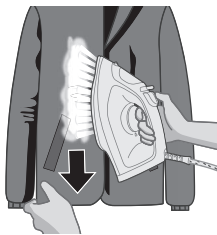

- 4 Razvucite odevni predmet dok primenjujete dodatnu količinu pare da biste uklonili uporne nabore (samo za DST2020 i DST2030).



- 5 Nemojte da koristite голу šaku kao površinu za podršku prilikom peglanja.

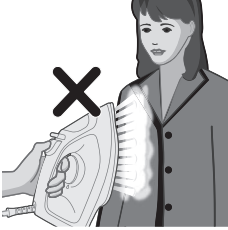

- 6 Nemojte da okrećete aparat prema sebi / drugoj osobi.

## Režim automatskog isključivanja (DST2030)



- 1 Da biste bili bezbrižni, aparat će se ohladiti samostalno ako ga određeni period ostavite bez nadzora.

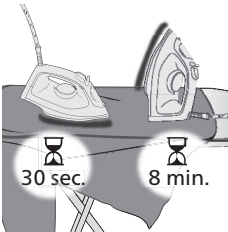
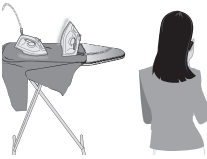

- 2 Kada se aparat ne koristi duže od 30 sekundi dok leži na grejnoj ploči ili 8 minuta u uspravnom položaju / na postolju, on će preći u režim automatskog isključivanja.

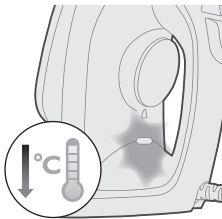

- 3 Temperatura aparata će se smanjiti u režimu automatskog isključivanja. Indikator „Pegla je spremna” takođe će neprestano treperiti, što znači da se aparat nalazi u statusu automatskog isključivanja. Da biste potpuno isključili aparat, isključite ga iz zidne utičnice.

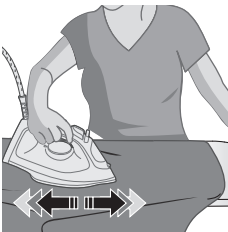

- 4 Da biste omogućili da se aparat ponovo zagreje, podignite ga ili ga malo pomerite.

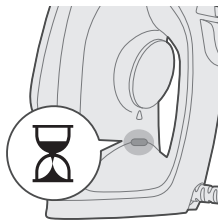

5 Indikator „Pegla je spremna“ će se uključiti, što ukazuje na to da se aparat zagreva.

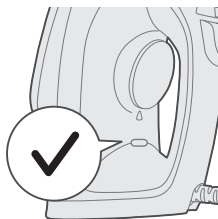

6 Kada se indikator „Pegla je spremna“ isključi, aparat je spreman za korišćenje.

## Čišćenje i održavanje

1 Uverite se da aparat nije uključen u zidnu utičnicu.

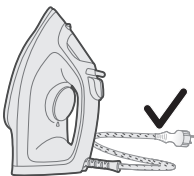
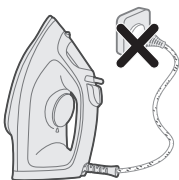

2 Uverite se da se aparat ohladio.

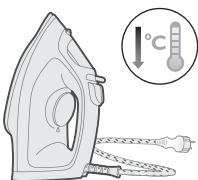

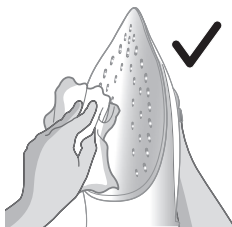

- 3 Vlažnom krpom obrišite ljustice i druge naslage sa grejne ploče.

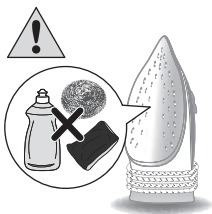

Napomena: Da bi grejna ploča uvek bila glatka, izbegavajte kontakt sa metalnim predmetima. Za čišćenje grejne ploče nemojte da koristite žicu za ribanje, sirće ili druge hemikalije.

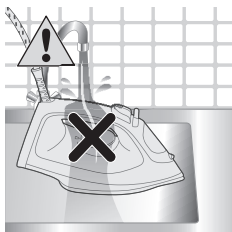

- 4 Nemojte da perete / čistite aparat pod mlazom vode.

## Čišćenje kamenca

Koristan savet: Funkciju Quick Calc Release možete da upotrebite u svakom trenutku. Ako živite u oblasti gde je voda tvrda, ovu funkciju koristite češće.



- 1 Preporučuje se da nakon 1 meseca upotrebe obavite čišćenje kamenca da biste uklonili naslage iz uređaja, produžili njegov radni vek i osigurali zagrevanje.

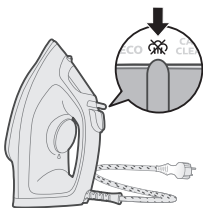

2 Uverite se da je pegla isključena iz zidne utičnice i da je podešen režim bez pare (suvo peglanje) .

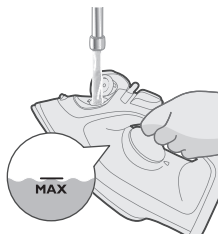

3 Napunite rezervoar vodom do oznake MAX.

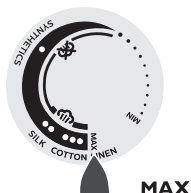

4 Podesite regulator temperature na MAX.

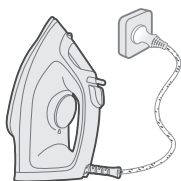

5 Uključite aparat u uzemljenu zidnu utičnicu.

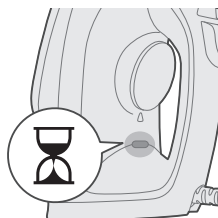

6 Indikator „Pegla je spremna“ će se uključiti, što ukazuje na to da se aparat zagreva.

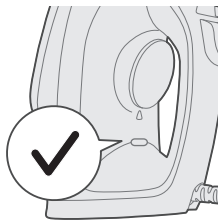

7 Sačekajte da se indikator spremnosti isključi.

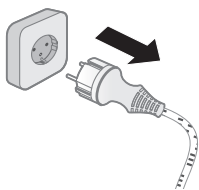

8 Isključite peglu iz zidne utičnice.

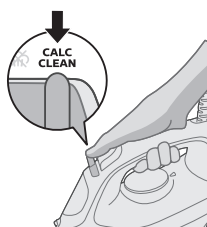

9 Pomerite birač postavke pare u položaj za čišćenje kamenca i zadržite ga.



10 Držite peglu iznad sudopere i blago je protresite. Vruća voda i čestice kamenca će izlaziti iz grejne ploče.

Oprez: Dok se kamenac ispira, para i ključala voda takode će izlaziti iz grejne ploče.

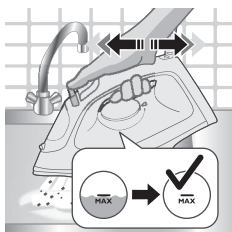

11 Nastavite da tresete peglu dok ne izade sva voda iz rezervoara.





**12** Priključite aparat u zidnu utičnicu i ostavite ga da se zagreje kako bi se grejna ploča osušila. Ovo traje oko 2 minuta.

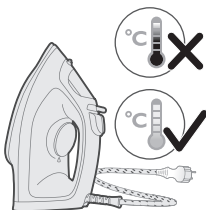

**13** Ostavite peglu da se ohladi.

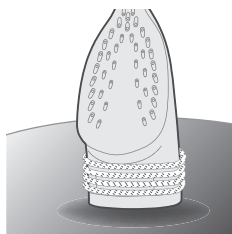

**14** Namotajte kabl oko donjeg dela pegle.

## Odlaganje

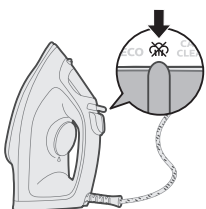

**1** Pomerite birač postavke pare da biste izabrali režim bez pare (suvo peglanje) ~~☁~~.

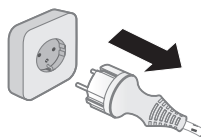

**2** Isključite aparat iz zidne utičnice.

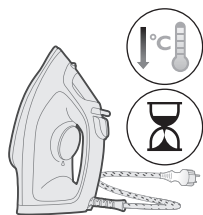

3 Ostavite aparat da se ohladi.

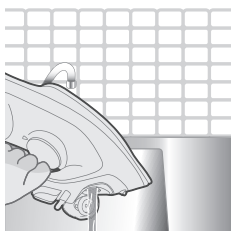

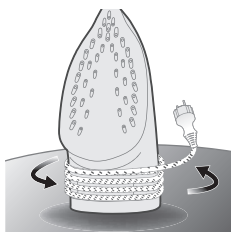

4 Prospite preostalu vodu iz rezervoara za vodu.



5 Namotajte kabl za napajanje oko glavnog kućišta aparata.

## Rešavanje problema

U ovom poglavlju kratko su navedeni najčešći problemi do kojih može da dode sa aparatom. Ako ne uspete da rešite problem pomoću informacija navedenih u nastavku, posetite [www.philips.com/support](http://www.philips.com/support) da biste pronašli listu najčešćih pitanja ili se obratite centru za korisničku podršku u svojoj zemlji.

Problem	Mogući uzrok	Rešenje
Pegla ne može da ukloni nabore sa odevnog predmeta.	Ne generiše se para tokom peglanja.	Napunite rezervoar za vodu, a prekidač za paru postavite u položaj  .
Pegla ne proizvodi paru.	U rezervoaru za vodu nema dovoljno vode.	Napunite rezervoar za vodu.
	Prekidač za paru je postavljen u položaj  .	Podesite prekidač za paru u položaj  .

	Pegla još uvek nije dovoljno zagrejana da bi proizvodila paru.	Kada se pegla zagreva, indikator „Pegla je spremna“ stalno svetli. Kada je pegla spremna za upotrebu, svetlo se isključuje.
Na tkaninu kaplje voda u toku peglanja.	Funkciju dodatne količine koristili ste suviše često u kratkom vremenskom periodu.	Nastavite da peglate u horizontalnom položaju i sačekajte neko vreme pre nego što ponovo upotrebite funkciju mlaza pare.
	Niste pravilno zatvorili poklopac rezervoara za vodu.	Pritiskajte poklopac sve dok ne čujete „klik“.
Pegla ne proizvodi mlaz pare.	Funkciju dodatne količine pare koristili ste suviše često u kratkom vremenskom periodu.	Nastavite da peglate u horizontalnom položaju i sačekajte neko vreme pre nego što ponovo upotrebite funkciju mlaza pare.
	Pegla još uvek nije dovoljno vruća za peglanje.	Sačekajte dok indikator „Pegla je spremna“ ne prestane da pulsira i počne stalno da svetli.
	Stavili ste neku hemikaliju u rezervoar za vodu.	Isperite rezervoar za vodu i nemojte da stavljate parfem niti bilo koju hemikaliju u njega.
Iz grejne ploče curi voda nakon isključivanja pegle iz električne mreže.	Prekidač za paru je postavljen u položaj  .	Podesite prekidač za paru u položaj  .
	Pegla je stavljena u horizontalni položaj, a u rezervoaru je ostalo još vode.	Ispraznite rezervoar za vodu nakon korišćenja ili odložite peglu u vertikalnom položaju.
Pegla uglašava odevne predmete ili ostavlja otiske na njima.	Površina za peglanje bila je neravna, na primer zato što ste peglali preko šava ili preklopa na odevnom predmetu.	Pegla je bezbedna za upotrebu na svim odevnim predmetima koji mogu da se peglaju. Uglašanost ili otisak nije trajan i nestaće nakon pranja odevnog predmeta. Izbegavajte peglanje preko šavova ili preklopa. Možete i da stavite pamučnu tkaninu preko površine koju peglate kako biste sprečili pojavu otisaka.

# Johdanto

Onnittelut ostoksestasi ja tervetuloa Philips-tuotteen käyttäjäksi! Hyödynnä Philipsin tukipalveluita rekisteröimällä tuotteesi osoitteessa [www.philips.com/welcome](http://www.philips.com/welcome). Lue tämä käyttöopas, Tärkeitä tietoja -lehtinen ja pikaopas huolellisesti ennen laitteen käyttöä. Säilytä ne myöhempiä tarvetta varten.

## Tuotteen yleiskuvaus

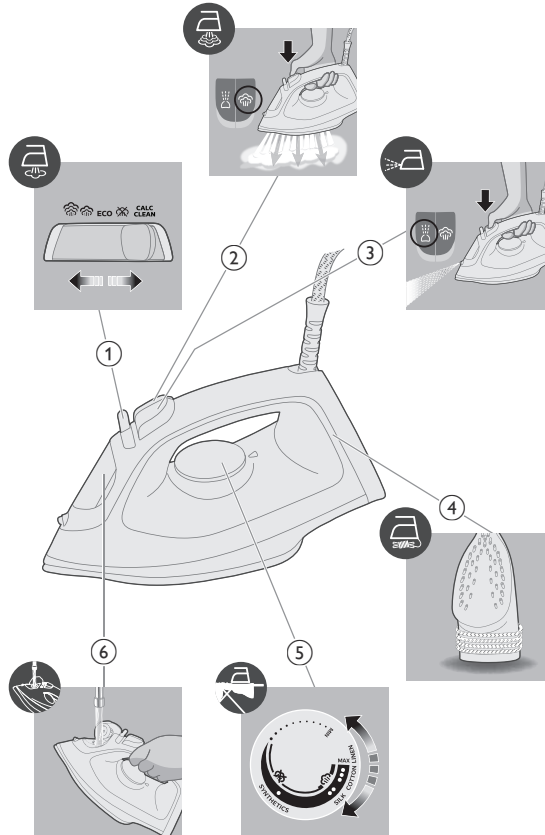

- 1 Höyrynvalitsin
- 2 Höyrysuihkauspainike
- 3 Sumutin
- 4 Johdon kiertäminen
- 5 Lämpötilanvalitsin
- 6 Vesisäiliön kansi

## Käyttö

### Käyttöönoton valmistelu

Huomaus: Ensimmäisellä käyttökerralla silitysrauta saattaa hieman höyrytä. Tämä loppuu jonkin ajan kuluttua.

#### Käytettävä vesityyppi

Laite soveltuu vesijohtoveden käyttöön. Jos asuinalueesi vesijohtovesi on kovaa, suosittelemme sekoittamaan vesijohtoveteen saman verran tislattua tai suoloista puhdistettua vettä. Tämä estää kalkin nopeaa kertymistä ja pidentää laitteen käyttöikää.

**Älä käytä hajustettua vettä, kuivausrummun vettä tai vettä, johon on lisätty etikkaa, tärkkiä, kalkinpoistoaineita, silitysaineita, kemiallisesti puhdistettua vettä tai muita kemikaaleja, koska se voi vahingoittaa laitetta tai aiheuttaa veden pirskahtelua ja ruskeita tahroja silitettävään kankaaseen.**

### Vesisäiliön täyttäminen

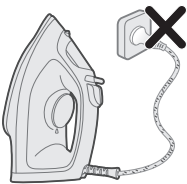

- 1 Älä kytke laitetta virtalähteeseen.

2 Varmista, että laite on jäähtynyt.

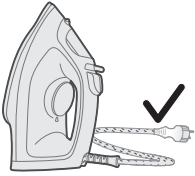

3 Valitse Ei höyryä -toiminto (kuivasilitys) liu'uttamalla höyryvalitsinta oikealle .

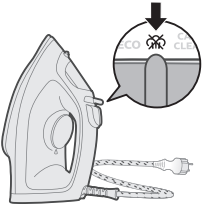

4 Avaa vesisäiliön kansi.

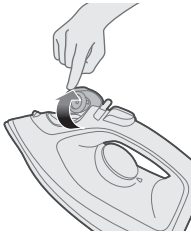

5 Täytä vesisäiliö vedellä MAX-merkkiin asti.

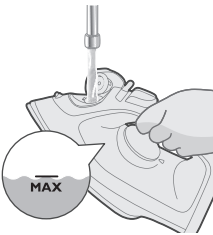

6 Sulje vesisäiliön kansi tiiviisti.

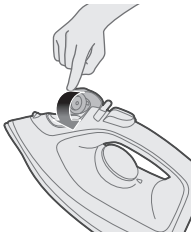

## Lämpötilan asettaminen



	MAX PELLAVA	
	● ● ● PUUVILLA	
	● ● SILKKI	<b>ECO</b>
	● TEKOKUITU	

ECO



ECO-asetus: Laite tuottaa höyryä vähimmäisteholla helposti siliävien kankaiden silittämiseen. Lisäksi asetusta säästää energiaa.



Kaksi höyrypilvettä: Laite tuottaa höyryä suuremmalla teholla vaikeiden ryppyjen poistamiseen.



Kolme höyrypilvettä: Laite tuottaa höyryä enimmäisteholla sitkeimpien ryppyjen poistamiseen.

## Käyttö

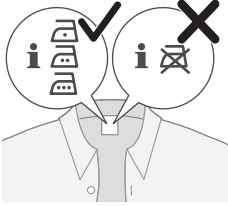

1 Tarkista silitysohjeet vaatteen hoito-ohjelapusta.

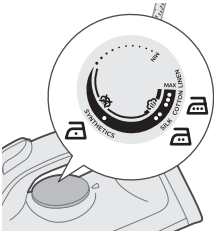

2 Valitse haluamasi silityslämpötila kääntämällä lämpötilanvalitsin vastaavan merkin kohdalle.

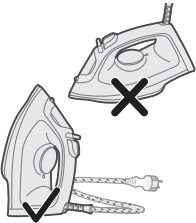

3 Aseta silitysrauta alustalle pystyasentoon.

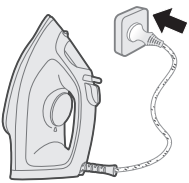

4 Liitä laite maadoitettuun seinäpistorasiaan.

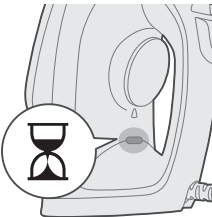

5 Silitysrauta valmis -merkkivalo syttyy merkiksi silitysraudan lämpenemisestä.



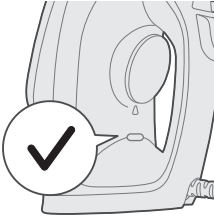

- 6 Kun Silitysrauta valmis -merkkivalo on sammunut, odota hetki ennen kuin alat silitää. Valmiusmerkkivalo syttyy ajoittain uudelleen silityksen aikana.

## Ei höyryä / kuivasilitys

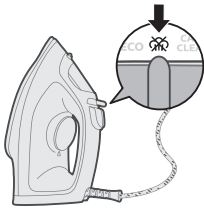

- 1 Aseta höyryasetukseksi Ei höyryä.

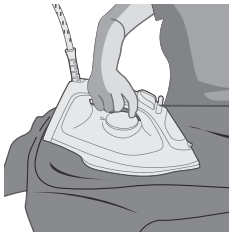

- 2 Höyryäminen loppuu hetken kuluttua silityksen aikana.

## Sumutin



- 1 Aseta höyryasetukseksi Ei höyryä. Paina sumutinpainiketta  sitkeimpien ryppyjen poistamiseksi.

## Lisähöyrysiuhkaus

- 1 Puuvilla ja pellava: aseta lämpötilanvalitsin MAX-asetukseen.

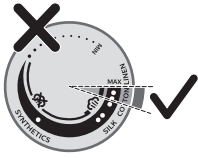

- 2 Poista sitkeät rypyt painamalla höyrysiuhkauspainiketta.



- 3 Höyrysiuhkausta voi käyttää myös, kun höyrysilitysrautaa pidetään pystyasennossa. Silloin voidaan poistaa ryppejä ja laskoksia riippuvista vaatteista (vain mallit DST2020 ja DST2030).

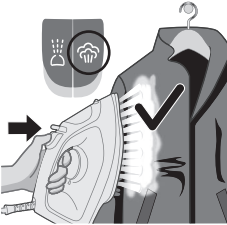

- 4 Poista sitkeät rypyt vetämällä ja venyttämällä vaatetta samalla, kun käytät höyrysiuhkaustoimintoa (vain mallit DST2020 ja DST2030).

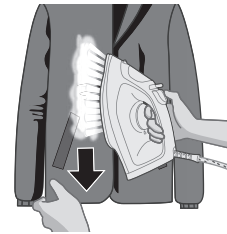

- 5 Älä tue laitetta paljaalla kädellä silityksen aikana.



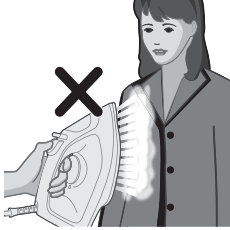

- 6 Älä osoita laitteella itseäsi tai toista henkilöä.

## Automaattinen virrankatkaisutila (DST2030)

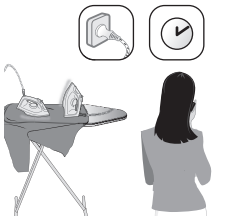

- 1 Laite alkaa jäähtyä itsestään, jos se on käyttämättömänä riittävän pitkään, joten voit olla rauhallisin mielin.

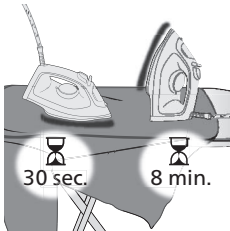

- 2 Laite siirtyy automaattisen virrankatkaisun tilaan, jos se on käyttämättömänä 30 sekunnin ajan pohjalevyllään tai 8 minuutin ajan pystyasennossa.

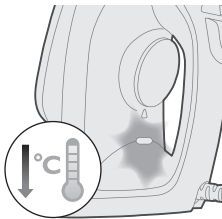

- 3 Laite alkaa jäähtyä automaattisen virrankatkaisun tilassa. Lisäksi Silitysrauta valmis -merkkivalo alkaa vilkkua, kun automaattinen virrankatkaisu on käytössä. Varmista laitteen virran katkeaminen irrottamalla se pistorasiasta.

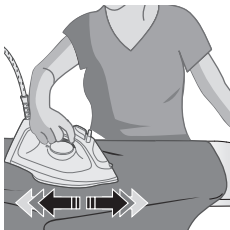

- 4 Kun haluat laitteen lämpenevän uudelleen, nosta tai liikuta sitä hieman.

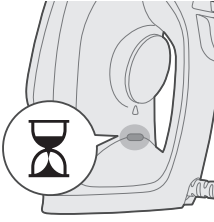

5 Silitysrauta valmis -merkkivalo syttyy merkiksi laitteen lämpeämisestä.

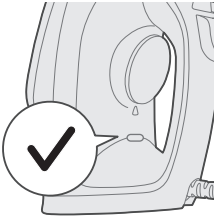

6 Laite on käyttövalmis, kun Silitysrauta valmis -merkkivalo on sammunut.

## Puhdistus ja huolto

1 Varmista, että laitetta ei ole liitetty verkkovirtaan.

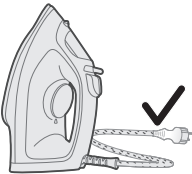
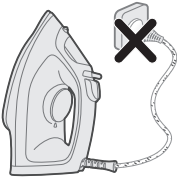

2 Varmista, että laite on jäähtynyt.

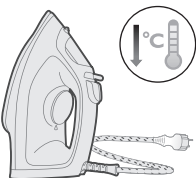

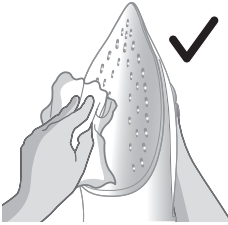

3 Pyyhi kalkkikertymät ja muut tahrat pohjasta kostealla liinalla.



Huomautus: Varo ettei pohja kosketa metallia, jotta se pysyy sileänä. Älä puhdistu pohjaa hankaustyynyillä, etikalla tai muilla kemikaaleilla.

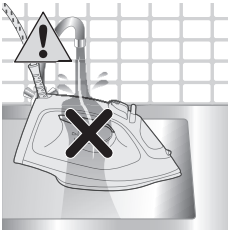

4 Älä pese/puhdistu laitetta juoksevilla vedellä.

## Calc-Clean

Vihje: Quick Calc Release -toimintoa voi käyttää milloin tahansa. Jos asut kovan veden alueella, käytä toimintoa useammin.

1 Suosittelemme, että teet laitteelle kalkinpoiston kuukauden välein, mikä pidentää sen käyttöikä ja varmistaa sen normaalin lämpenemisen.



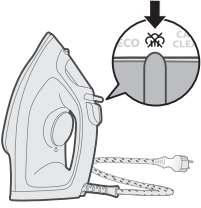

2 Varmista, että laitetta ei ole kytketty verkkovirtaan ja höyryasetuksena on Ei höyryä (kuivasilitys) .

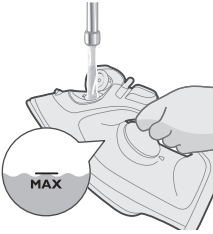

3 Täytä vesisäiliö vedellä MAX-merkkiin asti.



4 Aseta lämpötilanvalitsin MAX-asentoon.

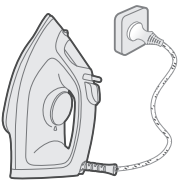

5 Liitä laite maadoitettuun seinäpistorasiaan.

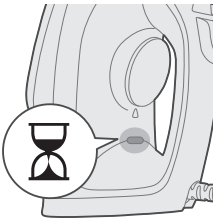

6 Silitysrauta valmis -merkkivalo syttyy merkiksi laitteen lämpeämisestä.

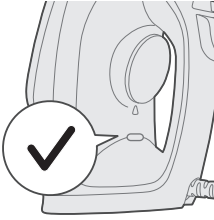

7 Odota, että Silitysrauta valmis -merkkivalo sammuu.

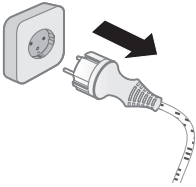

8 Irrota silitysraudan pistoke pistorasiasta.

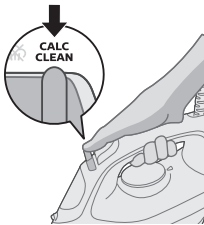

9 Pidä höyryvalitsinta Calc-Clean-asennossa.



10 Pidä silitysrautaa pesualtaan päällä ja ravista sitä samalla varovasti. Silitysraudan pohjasta tippuu kuumaa vettä ja kalkkihiukkasia.

Varoitus: Kalkin huuhtoutuessa pois laitteen pohjasta tulee myös höyryä ja kiehuvaa vettä.

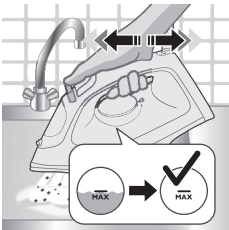

11 Ravista silitysrautaa, kunnes säiliössä ollut vesi on tippunut ulos.

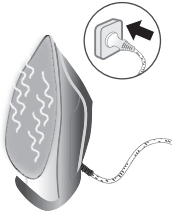

**12** Kytke laitteen pistoke pistorasiaan ja anna laitteen lämmetä, jotta pohja kuivuu. Tähän kuluu noin 2 minuuttia.

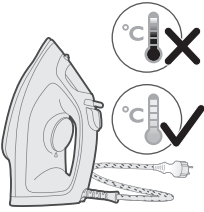

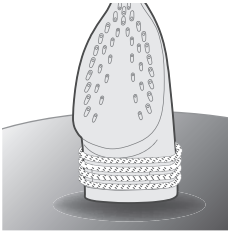

**13** Anna silitysraudan jäähtyä.

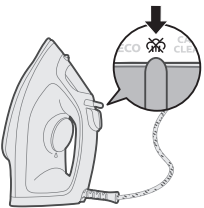

**14** Kierrä johto silitysraudan kannan ympärille.

## Säilytys



**1** Valitse Ei höyryä -tila (kuivasilitys) liu'uttamalla höyryvalitsinta .

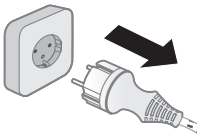

**2** Irrota pistoke pistorasiasta.



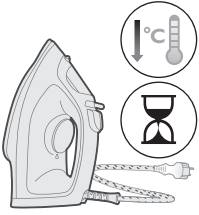

3 Anna laitteen jäähtyä.

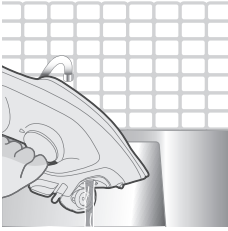

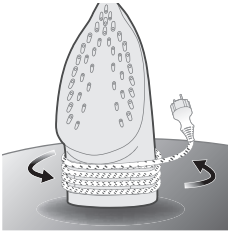

4 Kaada jäljelle jäänyt vesi pois vesisäiliöstä.



5 Kierrä virtajohto laitteen rungon ympärille.

## Vianmääritys

Tämä osio esittää lyhyesti yleisimmät ongelmat, joita saatat kohdata käyttäessäsi laitetta. Jos et löydä ongelmaasi ratkaisua seuraavista tiedoista, lue osoitteesta [www.philips.com/support](http://www.philips.com/support) vastauksia usein kysytyihin kysymyksiin tai ota yhteys paikalliseen kuluttajapalvelukeskukseen.

Ongelma	Mahdollinen syy	Ratkaisu
Silitysrauta ei poista ryppyjä vaatteesta.	Silityksen aikana ei ole höyryä.	Täytä vesisäiliö ja aseta höyrytimen säädin asentoon  .
Laitteesta ei tule lainkaan höyryä.	Säiliössä ei ole tarpeeksi vettä.	Täytä vesisäiliö.
	Höyrytimen säädin on asennossa  .	Aseta höyrytimen säädin asentoon  .
	Silitysrauta ei ole riittävän kuuma höyryntuottoa varten.	Kun silitysrauta lämpenee, Silitysrauta valmis -merkkivalo palaa yhtäjaksoisesti. Kun silitysrauta on käyttövalmis, merkkivalo sammuu.

## 410 Suomi

Vaatteelle tippuu vesipisaroita silityksen aikana.	Olet käyttänyt höyrysuihkaustoimintoa liian usein lyhyen ajan kuluessa.	Jatka silittämistä vaaka-asennossa ja odota hetki, ennen kuin käytät höyrysuihkausta uudelleen.
	Vesisäiliön kantta ei ole suljettu oikein.	Paina kantta, kunnes se napsahtaa paikalleen.
Höyrysuihkaus ei toimi.	Olet käyttänyt höyrysuihkaustoimintoa liian usein lyhyen ajan kuluessa.	Jatka silittämistä vaaka-asennossa ja odota hetki, ennen kuin käytät höyrysuihkausta uudelleen.
	Silitysrauta ei ole riittävän kuuma silittämistä varten.	Odota, että Silitysrauta valmis -merkkivalo lakkaa vilkkumasta ja palaa yhtäjaksoisesti.
	Olet lisännyt vesisäiliöön jotain kemikaalia.	Huuhtelee vesisäiliö, äläkä laita sinne hajusteita tai kemikaaleja.
Vesipisaroita valuu pohjasta, kun silitysraudan pistoke on irrotettu pistorasiasta.	Höyrytimen säädin on asennossa  .	Aseta höyrytimen säädin asentoon  .
	Höyryrauta on laitettu vaaka-asentoon, kun vesisäiliössä on vielä vettä.	Tyhjennä vesisäiliö käytön jälkeen tai säilytä silitysrautaa pystyasennossa.
Silitysraudasta jää vaatteeseen kiiltoa tai jälkiä.	Silitettävä pinta ei ole tasainen, koska silityskohdassa on esimerkiksi sauma tai vaatteen taitos.	Silitysrautaa voi käyttää turvallisesti kaikille silitettävälle kankaille. Kiilto tai jälki eivät ole pysyviä vaan häviävät, kun peset vaatteen seuraavan kerran. Vältä silitystä saumojen tai taitosten päältä. Voit myös asettaa silityskohdan päälle puuvillakankaan, jotta vaatteeseen ei jäisi jälkiä.



- 1 Ångväljare
- 2 Ångpuffsknapp
- 3 Spreja vatten
- 4 Linda sladden
- 5 Temperaturvred
- 6 Vattenbehållarlock

## Använda apparaten

### Förberedelser inför användning

Obs! Strykjärnet kan avge lite ånga första gången du använder det. Det upphör efter en kort stund.

#### Typ av vatten som kan användas

Apparaten kan användas med kranvatten. Om du bor i ett område med hårt vatten rekommenderar vi dock att du blandar en lika stor mängd kranvatten med destillerat eller demineraliserat vatten. Detta förhindrar att kalkavlagringar snabbt bildas och förlänger apparatens livslängd.

**Använd inte parfym, vatten från torktumlare, ättika, stärkelse, avkalkningsmedel, strykhjälpmiddel, kemiskt avkalkat vatten eller andra kemikalier eftersom det kan orsaka vattenstänk, bruna fläckar eller skada på apparaten.**

### Fylla vattenbehållaren

- 1 Anslut inte apparaten.

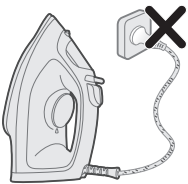

- 2 Kontrollera att apparaten har svalnat.

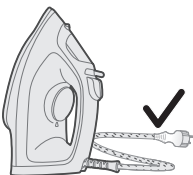

3 För ångväljaren åt höger för att välja inget ångläge (torr strykning) .

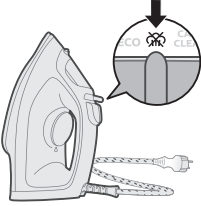

4 Öppna vattenbehållarlocket.

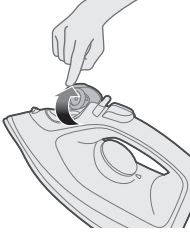

5 Fyll vattenbehållaren med vatten upp till vattenbehållarens MAX-märkning.

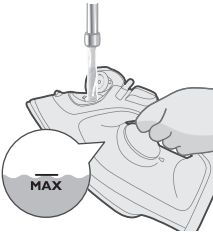

6 Stäng vattenbehållarlocket ordentligt.



## Ställa in temperaturen



MAX  
LINNE



● ● ● ●  
BOMULL



● ●  
SIDEN

ECO

●  
SYNTET

ECO



ECO-inställning: Minsta möjliga mängd konstant ånga avges för plagg med färre veck. Den här inställningen sparar också energi.



Två ångmoln: Mer konstant ånga avges för att få bort envisa veck.

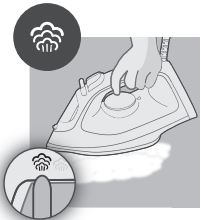

Tre ångmoln: Maximal mängd konstant ånga avges för att få bort envisa veck.

## Använda apparaten

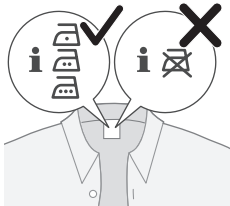

- 1 Läs strykinstruktionerna på plagget.

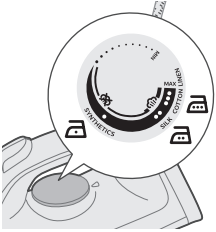

- 2 Ställ in temperaturvredet på önskad stryktemperatur genom att vrida det till lämplig temperaturindikering.

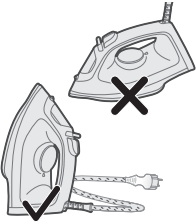

- 3 Låt strykjärnet stå på högkant.

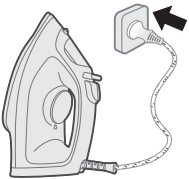

- 4 Anslut apparaten till ett jordat vägguttag.

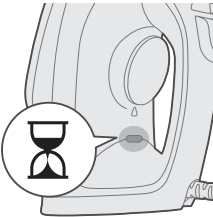

- 5 Klarlampan för strykning tänds vilket anger att strykjärnet håller på att värmas upp.

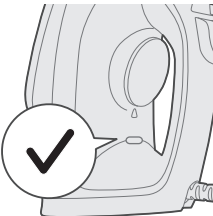

- 6 När klarlampan för strykning släcks ska du vänta en stund innan du börjar stryka. Klarlampan tänds då och då under strykningen.

## Ingen ånga/torr strykning

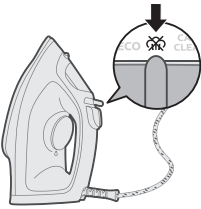

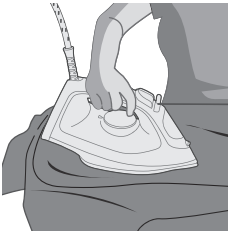

- 1 Ställ in ånginställningen på ingen ånga.

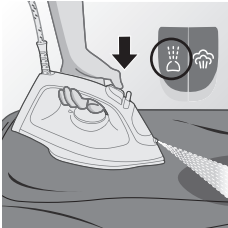

- 2 Efter en kort stund avges ingen ånga under strykningen.

## Spreja vatten



- 1 Ställ in ånginställningen på ingen ånga. Tryck in och släpp sedan vattensprejningsknappen  för att få en lätt dusch som hjälper till att ta bort envisa veck.

## Ångpuff

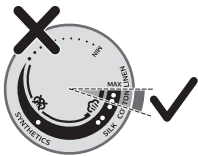

- 1 Ställ in temperaturvredet på MAX-inställningen mellan bomull och linne.



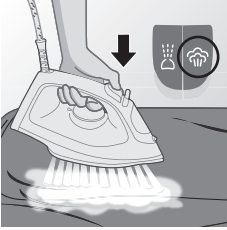

- 2 Tryck på ångpuffsknappen och släpp den sedan för att få en kraftig ångpuff som tar bort envisa veck.

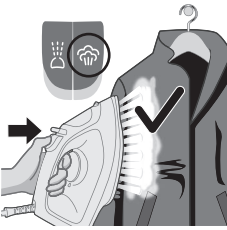

- 3 Du kan använda ångpuffsfunktionen när du håller strykjärnet i vertikalt läge. Det är praktiskt när du tar bort veck från upphängda plagg (endast för DST2020 och DST2030).

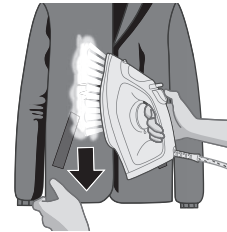

- 4 Dra och sträck plagget medan du använder ångpuffar för att ta bort envisa veck (endast för DST2020 och DST2030).



- 5 Använd inte din oskyddade hand som stödyta när du stryker.

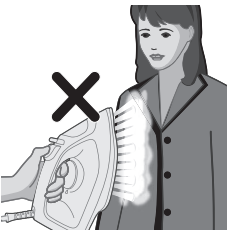

- 6 Placera inte apparaten vänd mot dig själv eller någon annan person.

## Automatisk avstängning (DST2030)

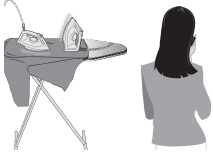

- 1 För att ge dig sinnesro svalnar apparaten på egen hand om den lämnas obevakad under en viss tid.

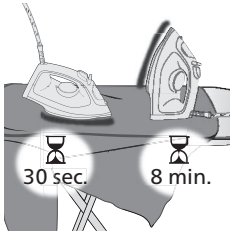

- 2 Om apparaten inte har använts på 30 sekunder när den vilar på stryksulan eller 8 minuter när den vilar på hälen/basen aktiveras läget för automatisk avstängning.

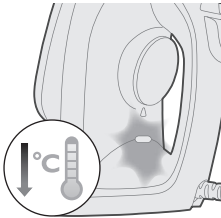

- 3 Apparaten sänks i läget för automatisk avstängning. Klarlampan för strykning blinkar även kontinuerligt för att ange att apparaten är i läget för automatisk avstängning. Dra ur nätsladden från eluttaget om du vill stänga av apparaten helt.

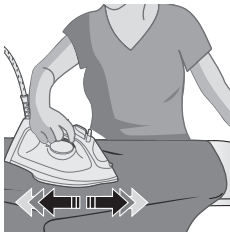

- 4 Ta upp apparaten eller flytta den lite om du vill värma upp den igen.

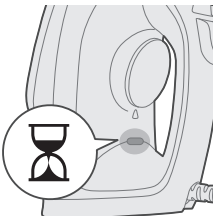

- 5 Klarlampan för strykning tänds vilket anger att apparaten håller på att värmas upp.

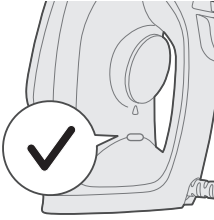

6 När klarlampan för strykning har släckts är apparaten redo att användas.

## Rengöring och underhåll

1 Kontrollera att apparaten är inte ansluten till elnätet.

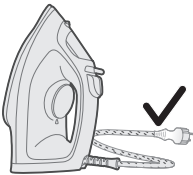
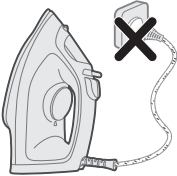

2 Kontrollera att apparaten har svalnat.

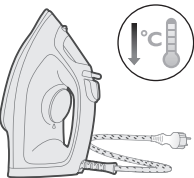

3 Torka bort flagor och andra avlagringar från stryksulan med en fuktad trasa.





Obs! Håll stryksulan slät genom att inte låta den komma i kontakt med metallföremål. Använd aldrig en kökssvamp, ättika eller andra kemikalier för att rengöra stryksulan.

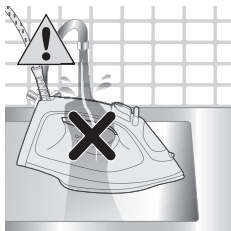

4 Tvätta/rengör inte apparaten under rinnande vatten.

## Avkalkning



Tips: Quick Calc Release-funktionen kan användas när som helst. Använd funktionen oftare om du bor i ett område med hårt vatten.

1 Du rekommenderas avkalka apparaten efter en månads användning för att ta bort kalkavlagringar som samlats upp från apparaten för att förlänga dess livslängd och säkerställa att apparaten värms upp.

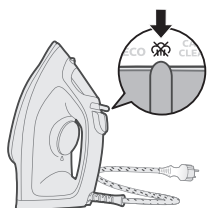

2 Kontrollera att strykJärnet är urkopplat och att ånginställningen är inställd på läget för ingen ånga (torr strykning) .

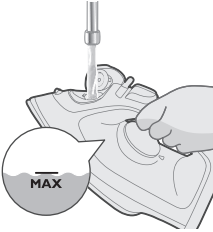

3 Fyll vattenbehållaren upp till MAX-markeringen.



4 Ställ in temperaturvredet på MAX.

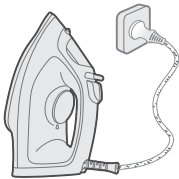

5 Anslut apparaten till ett jordat vägguttag.

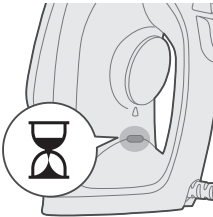

6 Klarlampan för strykning tänds vilket anger att apparaten håller på att värmas upp.

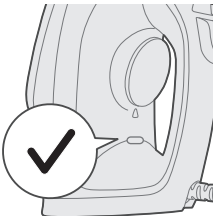

7 Vänta tills klarlampan för strykning släcks.

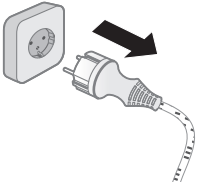

**8** Koppla ur strykjärnet.

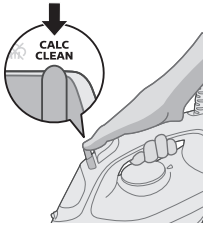

**9** För ångväjlaren till avkalkningsfunktionsläget och håll kvar.



**10** Håll strykjärnet över vasken och skaka försiktigt strykjärnet. Varmt vatten och kalkpartiklar kommer ut ur stryksulan.

Varning! Medan kalkavlagringar spolats ut kan det också komma ånga och kokande vatten från stryksulan.

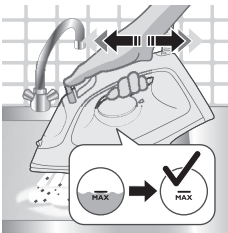

**11** Fortsätt att skaka försiktigt på strykjärnet tills vattenbehållaren har tömts helt på vatten.

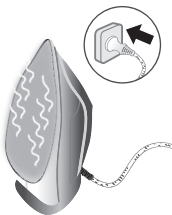

**12** Anslut apparaten igen och låt den värmas upp så att stryksulan torkar. Detta tar ungefär 2 minuter.

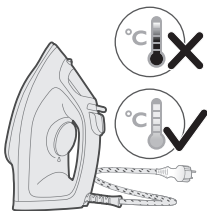

13 Låt strykjärnet svalna.

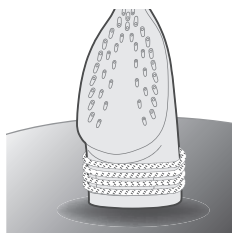

14 Linda sladden runt strykjärnets häl.

## Förvaring

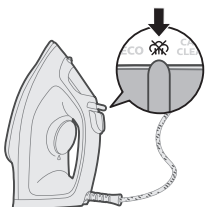

1 För ångväljaren för att välja inget ångläge (torr strykning) .

2 Dra ur nätsladden.

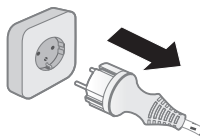

3 Låt apparaten svalna.

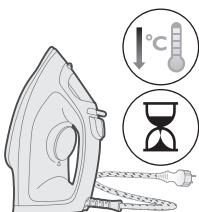

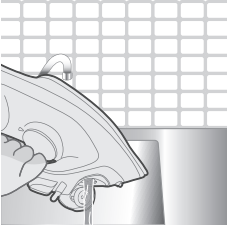

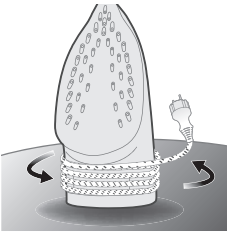

4 Häll ut kvarvarande vatten ur vattenbehållaren.





5 Linda nätsladden runt apparatens huvuddel.

## Felsökning

I det här kapitlet sammanfattas de vanligaste problemen som du kan råka ut för med apparaten. Om du inte kan lösa problemet med hjälp av informationen nedan kan du gå till [www.philips.com/support](http://www.philips.com/support) där det finns en lista med vanliga frågor. Du kan även kontakta kundtjänst i ditt land.

Problem	Möjlig orsak	Lösning
Strykjärnet tar inte bort veck från plagg.	Det avges ingen ånga under strykningen.	Fyll vattenbehållaren och ställ in ångreglaget på  .
Strykjärnet avger inte någon ånga.	Det finns inte tillräckligt med vatten i behållaren.	Fyll vattenbehållaren.
	Ångreglaget är inställt på  .	Ställ in ångreglaget på  .
	Strykjärnet har inte blivit tillräckligt varmt för att avge ånga.	När strykjärnet värms upp lyser klarlampan för strykning med fast sken. När strykjärnet är klart att användas släcks lampan.
Det droppar vatten på plagget under strykningen.	Du har använt ångpuffsfunktionen för ofta under en kort period.	Fortsätt att stryka i horisontellt läge och vänta en stund innan du använder ångpuffsfunktionen igen.
	Du har inte stängt locket till vattenbehållaren ordentligt.	Tryck på locket tills du hör ett klickljud.



Strykjärnet avger inte någon ångpuff.	Du har använt ångpuffsfunktionen för ofta under en kort period.	Fortsätt att stryka i horisontellt läge och vänta en stund innan du använder ångpuffsfunktionen igen.
	Strykjärnet har inte blivit tillräckligt varmt för strykning.	Vänta tills klarlampan för strykning har slutat blinka och lyser med ett fast sken.
	Du har tillsatt en kemikalie i vattenbehållaren.	Skölj vattenbehållaren och tillsätt inte någon parfym eller kemikalie efteråt.
Det droppar vatten från stryksulan när strykjärnets nätsladd har dragits ut.	Ångreglaget är inställt på  .	Ställ in ångreglaget på  .
	Strykjärnet står i horisontalläge och har fortfarande vatten i vattenbehållaren.	Töm vattenbehållaren efter användning eller förvara strykjärnet i vertikalt läge.
Strykjärnet lämnar glans eller avtryck på plagget.	Ytan som skulle strykas var ojämn, till exempel eftersom du strök över en söm eller ett veck i plagget.	Strykjärnet kan användas på alla strykbara plagg. Glansen eller avtrycket som strykjärnet efterlämnar är inte permanent utan försvinner när du tvättar plagget. Undvik att stryka över sömmar och veck. Du kan även lägga en tygbit av bomull över området som ska strykas om du vill undvika avtryck.

# Giới thiệu

Chúc mừng bạn đã mua hàng và chào mừng bạn đến với Philips! Để có được lợi ích đầy đủ từ sự hỗ trợ do Philips cung cấp, hãy đăng ký sản phẩm tại [www.philips.com/welcome](http://www.philips.com/welcome). Hãy đọc kỹ sách hướng dẫn sử dụng này, tờ rơi thông tin quan trọng và hướng dẫn sử dụng nhanh trước khi bạn sử dụng thiết bị. Hãy cất giữ để tiện tham khảo sau này.

## Tổng quan về sản phẩm

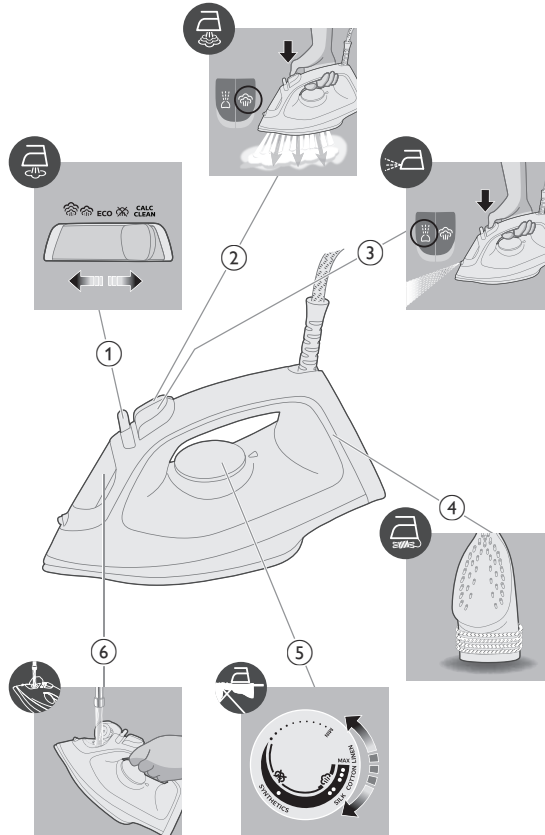

- 1 Cần gạt chọn chế độ hơi nước
- 2 Nút tăng cường hơi phun
- 3 Phun nước
- 4 Ngăn quần dây điện
- 5 Núm điều chỉnh nhiệt độ
- 6 Nắp ngăn chứa nước

## Sử dụng thiết bị

### Chuẩn bị sử dụng máy

Lưu ý: Bàn ủi có thể tỏa ra hơi nước khi bạn sử dụng lần đầu tiên. Hiện tượng này sẽ dừng sau một khoảng thời gian ngắn.

#### Loại nước được sử dụng

Thiết bị thích hợp để sử dụng với nước máy. Tuy nhiên, nếu bạn sống ở khu vực có nước cứng, bạn nên hòa một lượng bằng nhau nước máy và nước cất hoặc nước đã khử khoáng. Việc này sẽ ngăn tích tụ cặn nhanh và giúp kéo dài tuổi thọ của thiết bị.

**Không thêm nước hoa, nước từ máy sấy đảo, giấm, hồ vải, chất làm sạch cặn, chất phụ trợ ủi, nước đã được tẩy sạch bằng hóa chất hoặc các hóa chất khác, do các chất này có thể gây tình trạng phun nước, ổ vàng hoặc làm hỏng thiết bị của bạn.**

### Châm nước vào ngăn chứa nước

- 1 Không cắm điện thiết bị.

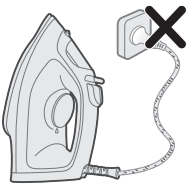

- 2 Đảm bảo thiết bị đã nguội.

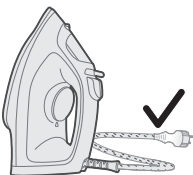

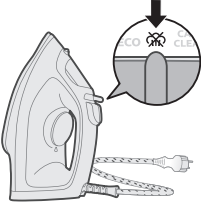

3 Gạt cần gạt chọn chế độ hơi nước sang bên phải để chọn chế độ không tạo hơi phun (ủ khô) .

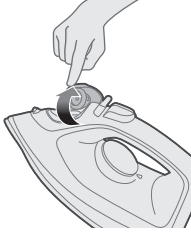

4 Lật mở nắp ngăn chứa nước.

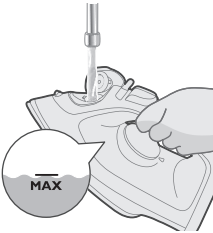

5 Châm nước vào ngăn chứa nước đến chỉ báo MAX (Tối đa).



6 Đậy chặt nắp ngăn chứa nước.

## Cài đặt nhiệt độ



MAX (TỐI ĐA)  
LINEN (VẢI LẠNH)



● ● ● ●  
COTTON (VẢI COTTON)





● ●  
SILK (LỤA)

ECO



●  
SYNTHETICS (VẢI SỢI TỔNG HỢP)



ECO



Cài đặt ECO (Tiết kiệm): Liên tục cung cấp hơi phun ổn định ở mức tối thiểu để ủi quần áo ít nếp nhăn hơn. Cài đặt này cũng tiết kiệm năng lượng.

☁



Hai đám mây hơi nước: Liên tục cung cấp hơi phun ổn định hơn để ủi các nếp nhăn khó ủi.

☁☁



Ba đám mây hơi nước: Liên tục cung cấp hơi phun tối đa để ủi các nếp nhăn khó ủi nhất.

## Sử dụng thiết bị

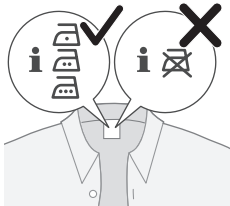

- 1 Kiểm tra nhãn quần áo để biết cách ủi cần thiết.

430 Tiếng Việt

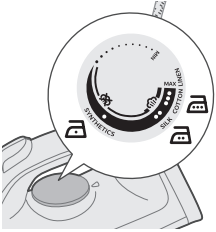

2 Đặt núm điều chỉnh nhiệt độ về nhiệt độ ủi cần thiết bằng cách xoay núm sang chỉ báo nhiệt độ thích hợp.

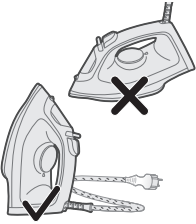

3 Dựng đứng bàn ủi để nghỉ.

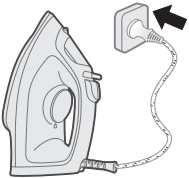

4 Cắm thiết bị vào ổ cắm trên tường có nối đất.

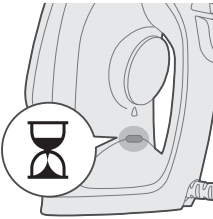

5 Đèn báo bàn ủi sẵn sàng sẽ sáng lên cho biết bàn ủi đang nóng lên.

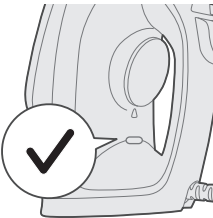

6 Khi đèn báo bàn ủi sẵn sàng tắt, hãy đợi một lúc trước khi bắt đầu ủi. Đèn báo sẵn sàng thành thạo sẽ sáng lên trong khi ủi.

## Không tạo hơi phun/Ủi khô

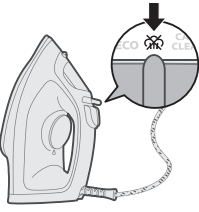

- 1 Thiết lập cài đặt hơi phun thành cài đặt không tạo hơi phun.

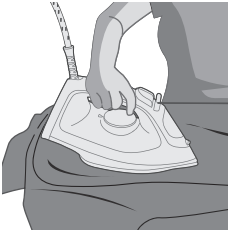

- 2 Sau một thời gian ngắn, hơi nước sẽ ngừng hoạt động trong khi ủi.

## Phun nước

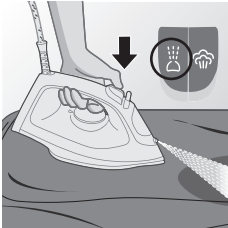

- 1 Thiết lập cài đặt hơi phun thành cài đặt không tạo hơi phun. Nhấn nút phun nước rồi thả ngón tay ra để tạo ra dòng hơi phun giúp ủi phẳng các nếp nhăn.

## Tăng cường hơi phun

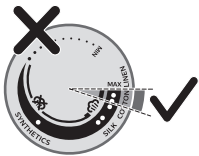

- 1 Vận nướm điều chỉnh nhiệt độ sang cài đặt MAX (Tối đa) giữa vải cotton và vải lanh.

## 432 Tiếng Việt

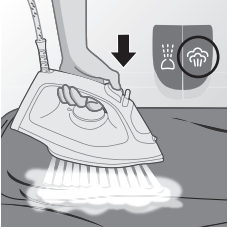

2 Nhấn nút tăng cường hơi phun rồi thả ngón tay ra để tạo ra đợt phun hơi nước mạnh giúp ủi phẳng các nếp nhăn khó ủi nhất.

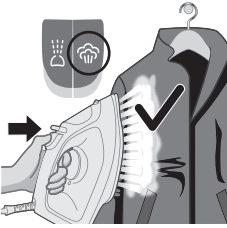

3 Bạn có thể sử dụng chức năng tăng cường hơi phun khi bạn cầm bàn ủi theo tư thế thẳng đứng để ủi phẳng các nếp nhăn trên quần áo đang treo (chỉ dành cho DST2020 và DST2030).

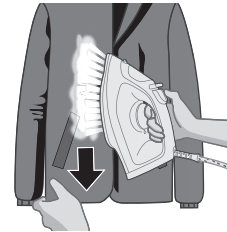

4 Kéo căng quần áo trong khi áp dụng chế độ tăng cường hơi phun để ủi phẳng các nếp nhăn khó ủi nhất (chỉ dành cho DST2020 và DST2030).



5 Không được sử dụng tay trần làm bề mặt đỡ khi ủi.



6 Không đặt thiết bị hướng về phía bạn/người khác.



## Tự động ngắt điện (DST2030)

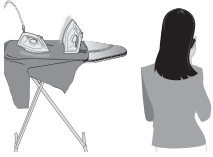

- 1 Để đảm bảo an toàn, thiết bị sẽ tự ngắt nếu không được sử dụng trong một khoảng thời gian.

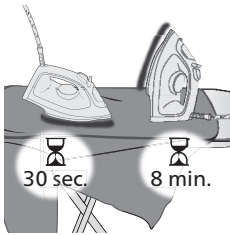

- 2 Khi thiết bị không được dùng trong hơn 30 giây khi đặt nằm ngang hoặc 8 phút khi dựng đứng, thiết bị sẽ chuyển sang chế độ tự động ngắt điện.

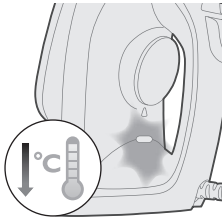

- 3 Nhiệt độ của thiết bị sẽ giảm ở chế độ tự động ngắt điện. Đèn báo bàn ủi sẵn sàng cũng sẽ nhấp nháy liên tục để cho biết thiết bị đang ở trạng thái tự động ngắt điện. Để tắt hoàn toàn thiết bị, hãy rút phích cắm của thiết bị ra khỏi ổ cắm.

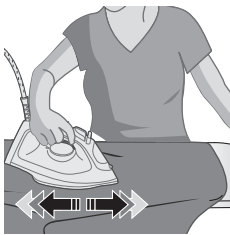

- 4 Để thiết bị nóng lên trở lại, hãy nhấc thiết bị lên hoặc di chuyển nhẹ bàn ủi.

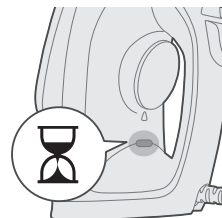

- 5 Đèn báo bàn ủi sẵn sàng sẽ sáng lên cho biết thiết bị đang nóng lên.

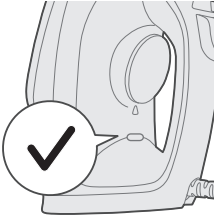

6 Khi đèn báo bàn ủi sẵn sàng tắt, tức là thiết bị đã sẵn sàng để sử dụng.

## Vệ sinh và bảo dưỡng

1 Đảm bảo thiết bị chưa cắm điện.

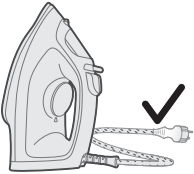
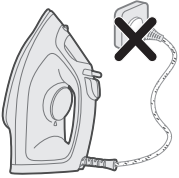

2 Đảm bảo thiết bị đã nguội.

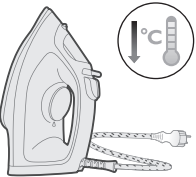

3 Lau sạch các mảnh vụn và cặn khác bám trên mặt đế bằng vải ẩm.





Lưu ý: Để giữ mặt đế bàn ủi trơn nhẵn, tránh va chạm mạnh với các đồ vật kim loại. Tuyệt đối không sử dụng miếng cọ rửa, giấm hoặc các hóa chất khác để làm sạch mặt đế.

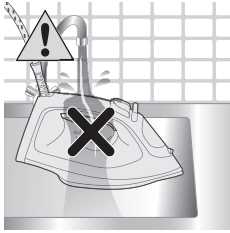

4 Không rửa/ làm sạch thiết bị dưới vòi nước chảy.

## Tẩy cặn Calc-Clean



Mẹo: Có thể sử dụng chức năng Xả vôi hóa nhanh bất kỳ lúc nào. Hãy sử dụng chức năng này thường xuyên hơn nếu bạn sống ở khu vực có nước cứng.

1 Sau 1 tháng sử dụng, bạn nên thực hiện tẩy cặn để loại bỏ cặn bám trên thiết bị nhằm kéo dài tuổi thọ của thiết bị và đảm bảo thiết bị nóng lên.

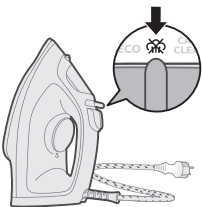

2 Đảm bảo bàn ủi đã được rút phích cắm và cài đặt hơi phun được đặt ở chế độ không tạo hơi phun (ủi khô) .



3 Châm nước vào ngăn chứa nước đến chỉ báo MAX (Tối đa).



4 Đặt núm điều chỉnh nhiệt độ đến chỉ báo MAX (Tối đa).

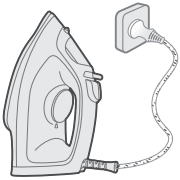

5 Cắm thiết bị vào ổ cắm trên tường có nối đất.

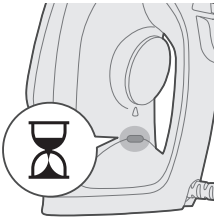

6 Đền báo bàn ủi sẵn sàng sẽ sáng lên cho biết thiết bị đang nóng lên.

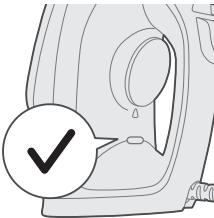

7 Đợi đèn báo bàn ủi sẵn sàng tắt.

8 Rút phích cắm bàn ủi.

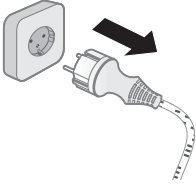

9 Gạt cần gạt chọn chế độ hơi nước đến vị trí Calc-Clean và giữ cần gạt ở vị trí đó.

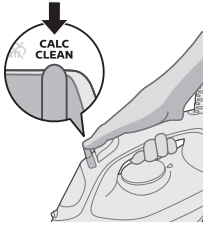

10 Cầm bàn ủi phía trên bồn rửa và lắc nhẹ bàn ủi. Nước nóng và các hạt cặn sẽ thoát ra từ mặt đế.



Thận trọng: Trong khi cặn được xả ra ngoài, hơi nước và nước sôi cũng thoát ra từ mặt đế.

11 Tiếp tục lắc bàn ủi cho đến khi chảy hết nước trong ngăn chứa nước ra.

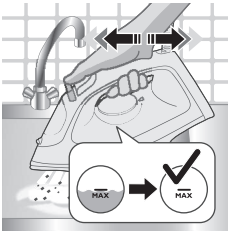

12 Cắm phích cắm bàn ủi và để bàn ủi nóng lên để làm khô mặt đế. Thao tác này mất khoảng 2 phút.



## 438 Tiếng Việt

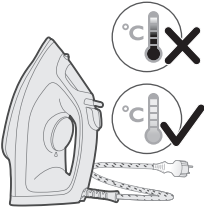

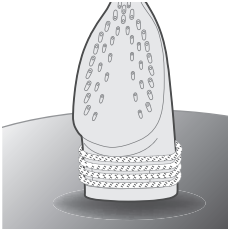

13 Để bàn ủi nguội.

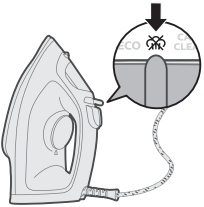

14 Quấn dây điện quanh đế tựa của bàn ủi.

## Bảo quản



1 Gạt cần gạt chọn chế độ hơi nước để chọn chế độ không tạo hơi phun (ủi khô) .

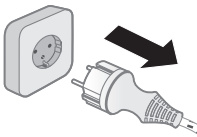

2 Rút phích cắm của thiết bị.

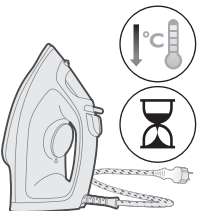

3 Để thiết bị nguội xuống.

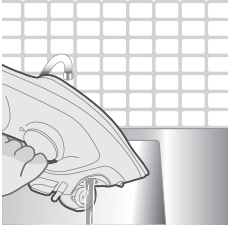

4 Đổ hết nước còn dư ra khỏi ngăn chứa nước.

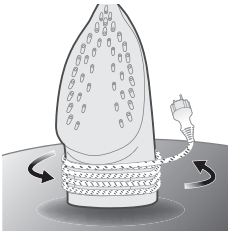



5 Quấn dây điện quanh thân chính của thiết bị.

## Khắc phục sự cố

Chương này tóm tắt các sự cố thường gặp phải với thiết bị này. Nếu bạn không thể xử lý vấn đề bằng các thông tin bên dưới, hãy truy cập [www.philips.com/support](http://www.philips.com/support) để xem danh sách các câu hỏi thường gặp hoặc liên hệ với Trung tâm Chăm sóc Khách hàng tại quốc gia bạn.

Sự cố	Nguyên nhân có thể	Giải pháp
Bàn ủi không ủi phẳng nếp nhăn trên quần áo.	Không có hơi nước trong khi ủi.	Châm nước vào ngăn chứa nước và gạt nút trượt hơi nước sang  .
Bàn ủi không phun hơi nước.	Không có đủ nước trong ngăn chứa nước.	Châm nước vào ngăn chứa nước.
	Nút trượt hơi nước được đặt ở  .	Gạt nút trượt hơi nước sang  .
	Bàn ủi chưa đủ nóng để tạo hơi phun.	Khi bàn ủi nóng lên, đèn báo “bàn ủi sẵn sàng” sáng liên tục. Khi bàn ủi đã sẵn sàng để sử dụng, đèn sẽ tắt.
Có giọt nước nhỏ xuống quần áo trong khi ủi.	Bạn sử dụng chức năng tăng cường quá thường xuyên trong một khoảng thời gian ngắn.	Tiếp tục ủi theo chiều ngang và đợi một lúc trước khi sử dụng lại chức năng tăng cường hơi phun.
	Bạn chưa đóng nắp ngăn chứa nước đúng cách.	Nhấn nắp cho đến khi bạn nghe tiếng ‘tách’.
Bàn ủi không tạo ra hơi phun tăng cường.	Bạn sử dụng chức năng tăng cường hơi phun quá thường xuyên trong một khoảng thời gian ngắn.	Tiếp tục ủi theo chiều ngang và đợi một lúc trước khi sử dụng lại chức năng tăng cường hơi phun.

	Bàn ủi chưa đủ nóng để ủi.	Đợi cho đến khi đèn báo 'bàn ủi sẵn sàng' ngừng nhấp nháy và sáng liên tục.
	Bạn đã bỏ hóa chất vào ngăn chứa nước.	Rửa sạch ngăn chứa nước và không cho bất kỳ loại nước hoa hay hóa chất nào vào ngăn chứa nước.
Nước nhỏ giọt từ mặt đế sau khi rút phích cắm bàn ủi.	Nút trượt hơi nước được đặt ở  .	Gạt nút trượt hơi nước sang  .
	Bạn đã đặt bàn ủi ở tư thế nằm ngang khi vẫn còn nước trong ngăn chứa nước.	Đổ hết nước trong ngăn chứa nước sau khi sử dụng hoặc cất giữ bàn ủi theo tư thế thẳng đứng.
Bàn ủi để lại vết bóng hoặc vết hằn trên quần áo.	Bề mặt cần ủi không bằng phẳng, chẳng hạn như do bạn ủi lên một đường may hoặc nếp gấp trên quần áo.	Bàn ủi an toàn khi sử dụng trên tất cả các loại vải có thể ủi được. Vết bóng hoặc vết hằn không lưu lại vĩnh viễn và sẽ mất đi khi bạn giặt quần áo. Tránh ủi lên các đường may hoặc nếp gấp. Bạn cũng có thể đặt một miếng vải cotton lên khu vực cần ủi để tránh để lại vết hằn.



## Giriş

Satın alma tercihiniz için teşekkür ederiz, Philips'e hoş geldiniz! Philips'in sunduğu destekten tam olarak yararlanmak için ürününüzü [www.philips.com/welcome](http://www.philips.com/welcome) adresinde kaydettirin. Cihazı kullanmadan önce bu kullanım kılavuzunu, önemli bilgi broşürünü ve hızlı başlangıç kılavuzunu dikkatlice okuyun. Bunları gelecekte başvurmak üzere saklayın.

## Ürün hakkında genel bilgiler

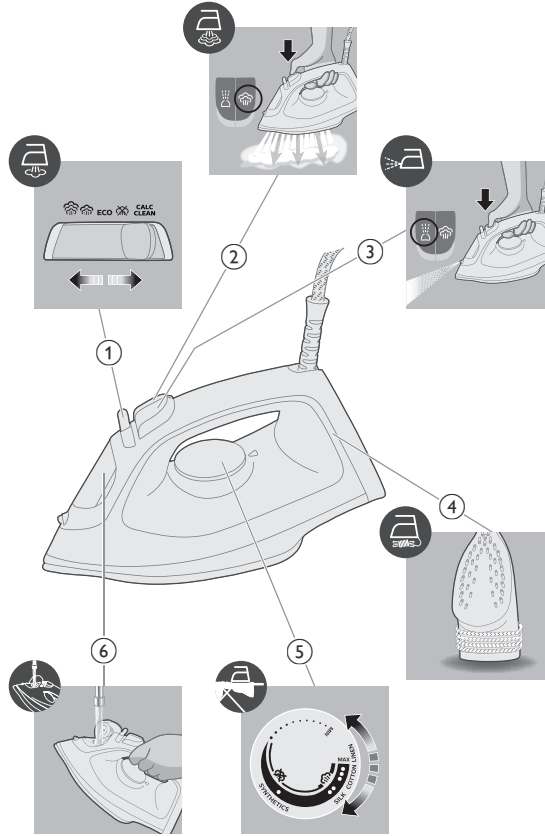

- 1 Buhar seçme düğmesi
- 2 Buhar püskürtme düğmesi
- 3 Su spreyi
- 4 Kablo sarma
- 5 Sıcaklık kadranı
- 6 Su haznesi kapağı

## Cihazı kullanma

### Cihazın kullanıma hazırlanması

Not: İlk kullanımında ütünün bir miktar buhar çıkarması normaldir. Bu, kısa bir süre sonra duracaktır.

#### **Kullanılabilir su türleri**

Cihaz musluk suyuyla kullanıma uygundur. Ancak su sertliği yüksek olan bir bölgede yaşıyorsanız musluk suyunu eşit miktarda damıtılmış veya demineralize suyla karıştırmanızı öneririz. Bu, hızlı kireç birikmesini önleyerek cihazın ömrünü uzatacaktır.

**Suyun sızmasına veya kahverengi lekelerle sebep olabileceğinden ve cihazınıza zarar verebileceğinden parfüm, kurutma makinesinde biriken su, sirke, kola, kireç çözücü maddeler, ütülemeye yardımcı ürünler, kimyasal olarak kireçten arındırılmış su veya başka kimyasallar eklemeyin.**

### Su haznesinin doldurulması

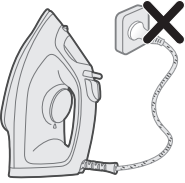

- 1 Cihazın fişini prize takmayın.

2 Cihazın soğuduğundan emin olun.

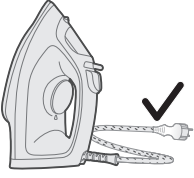

3 Buhar seçme düğmesini sağa kaydırarak buharsız modu (kuru ütüleme) seçin.

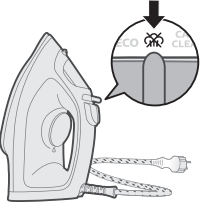

4 Su haznesi kapağını çevirerek açın.

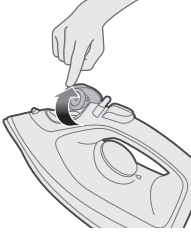

5 Su haznesindeki MAX seviyesine kadar su doldurun.

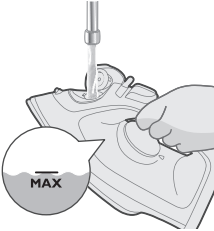

6 Su haznesi kapağını sıkıca kapatın.



## Sıcaklığı ayarlama



MAX (MAKS)  
LINEN (KETEN)



● ● ● ●  
COTTON (PAMUKLU)



● ●  
SILK (İPEK)

**ECO**



●  
SYNTHETICS (SENTETİK)



ECO



ECO ayarı: Daha az kırışık giysiler için minimum kesintisiz buhar sunar. Bu ayar ayrıca enerji tasarrufu sağlar.



İki buhar bulutu: Zorlu kırışıklıklar için daha fazla kesintisiz buhar sunar.



Üç buhar bulutu: İnatçı kırışıklıklar için maksimum kesintisiz buhar sunar.

## Cihazı kullanma

- 1 Gereklü ütüleme talimatları için giysi etiketini kontrol edin.

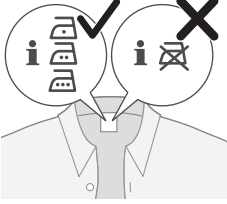

- 2 Sıcaklık kadranını uygun sıcaklık göstergesine çevirerek gereken ütüleme sıcaklığını ayarlayın.

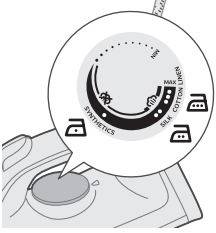

- 3 Ütüyü dayanağının üzerine yerleştirin.

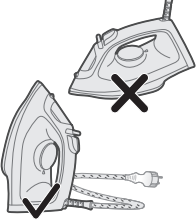

- 4 Cihazı topraklı prize takın.

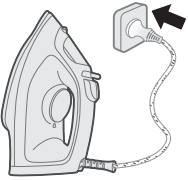

- 5 Ütünün ısındığını gösteren ütü hazır ışığı yanar.

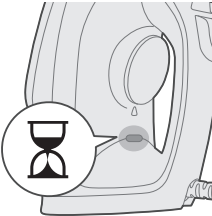

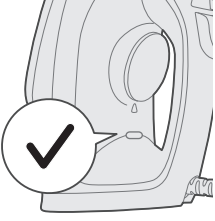

- 6 Ütü hazır ışığı söndüğünde, ütümeye başlamadan önce bir süre bekleyin. Hazır ışığı, ütümeye sırasında zaman zaman yanar.

## Buharsız/Kuru ütümeye

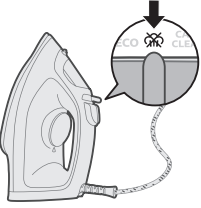

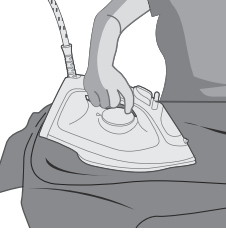

- 1 Buhar ayarını, buharsız ütümeye moduna getirin.

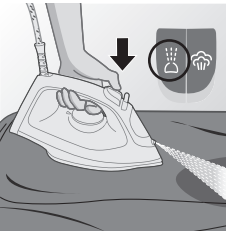

- 2 Kısa bir süre sonra ütümeye sırasında buhar çıkarma durur.

## Su spreyi



- 1 Buhar ayarını, buharsız ütümeye moduna getirin. İnatçı kırışıklıkları gidermek için su püskürtmek üzere su spreyi düğmesine  basın.

## Buhar püskürtme

- 1 Sıcaklık kadranını pamuk ve keten arasında MAX ayarına getirin.

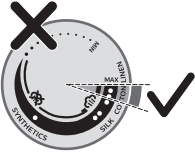

- 2 İnatçı kırışıklıkları gidermek için güçlü şekilde buhar püskürtmek üzere buhar püskürtme düğmesine basıp bırakın.



- 3 Buhar püskürtme işlevini, asılı giysilerdeki kırışıklıkları gidermek için ütüyü dikey konumda tutarken kullanabilirsiniz (yalnızca DST2020 ve DST2030 için).

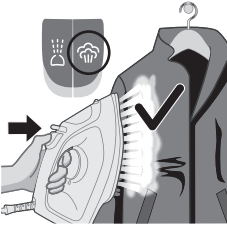

- 4 İnatçı kırışıklıkları gidermek için buhar püskürtürken giysinizi çekin ve gerin (yalnızca DST2020 ve DST2030 için).

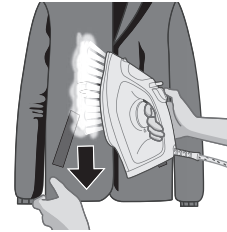

- 5 Ütü yaparken çıplak elinizi destek yüzeyi olarak kullanmayın.





6 Cihazı kendinize/başka bir kişiye doğrultmayın.

## Otomatik kapanma (DST2030)



1 İcinizi rahatlatmak için cihaz, belirli bir süre boyunca gözetimsiz bırakıldığında kendi kendine soğur.

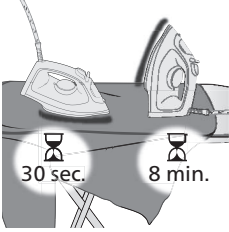
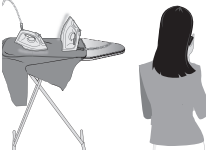

2 Cihaz, 30 saniyeden uzun süre tabanı üzerinde veya 8 dakikadan uzun süre dayanağı/arka kısmı üzerinde kullanılmadan durduğunda otomatik kapanma moduna girer.

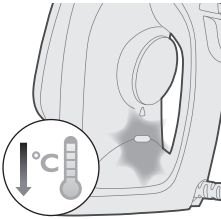

3 Otomatik kapanma modunda cihazın sıcaklığı düşer. Ütü hazır ışığı da cihazın otomatik kapanma durumunda olduğunu belirtmek için sürekli olarak yanıp söner. Cihazı tamamen kapatmak için fişini prizden çekin.

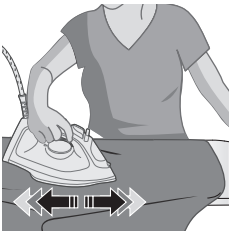

4 Cihazı tekrar ısınması için kaldırın veya hafifçe yerinden oynatın.



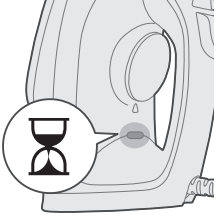

5 Cihazın ısınmakta olduğunu gösteren ütü hazır ışığı yanar.

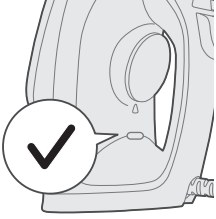

6 Ütü hazır ışığı söndükten sonra cihaz kullanıma hazırdır.

## Temizlik ve bakım

1 Cihazın fişinin prize takılı olmadığından emin olun.

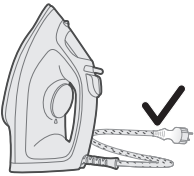
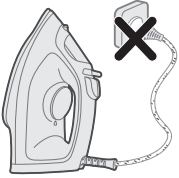

2 Cihazın soğuk olduğundan emin olun.

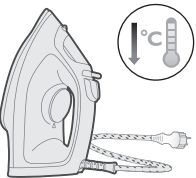

## 450 Türkçe

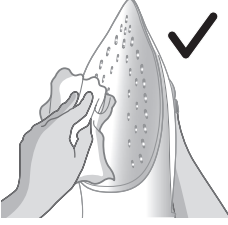

3 Tabandaki tortuları ve diğer kalıntıları nemli bir bezle silin.



Not: Tabanın pürüzsüz kalmasını sağlamak için metal cisimlerle temas ettirmeyin. Tabanı temizlemek için bulaşık süngeri, sirke veya başka kimyasallar kullanmayın.



4 Cihazı akan suyun altında yıkamayın/temizlemeyin.

## Calc-Clean



İpucu: Hızlı Kireç Çözme işlevi her zaman kullanılabilir. Suyun sert olduğu bir bölgede yaşıyorsanız bu işlevi daha sık kullanın.

1 1 aylık kullanımdan sonra kullanım ömrünü uzatmak ve ısınma performansını korumak için cihazınızda biriken kireci temizlemek üzere kireç temizleme işlemi yapmanız önerilir.

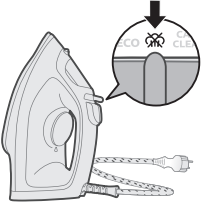

- 2 Ütünün fişinin çekildiğinden ve buhar ayarının buharsız moda (kuru ütüleme)  ayarlandığından emin olun.

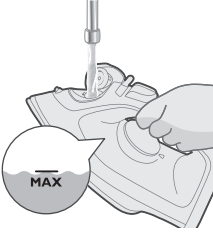

- 3 Su haznesini MAX seviyesine kadar doldurun.



- 4 Sıcaklık kadranını MAX olarak ayarlayın.

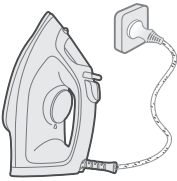

- 5 Cihazı topraklı prize takın.

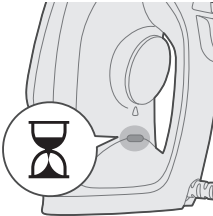

- 6 Cihazın ısınmakta olduğunu gösteren ütü hazır ışığı yanar.

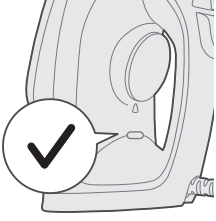

7 Ütü hazır ışığının sönmelerini bekleyin.

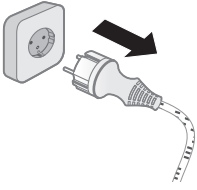

8 Ütünün fişini çekin.

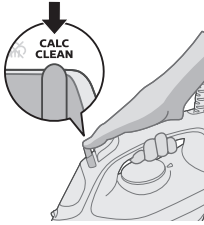

9 Buhar seçme düğmesini Calc-Clean konumuna kaydırın ve bu konumda tutun.



10 Ütüyü lavabonun üzerinde tutun ve hafifçe sallayın. Tabandan sıcak su ve kireç parçacıkları çıkacaktır.

Dikkat: Kireç atılırken ütünün tabanından kaynar su ve buhar da çıkar.



11 Su haznesindeki tüm su bitene kadar ütüyü sallamaya devam edin.

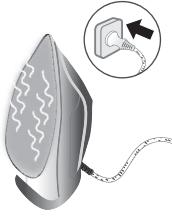

- 12** Cihazın fişini prize takın ve tabanın kuruması için cihazın ısınmasını bekleyin. Bu işlem yaklaşık 2 dakika sürer.

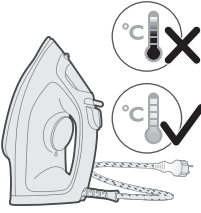

- 13** Ütünün soğumasını bekleyin.

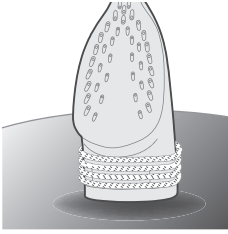

- 14** Kabloyu, ütünün dayanağının etrafına sarın.

## Saklama

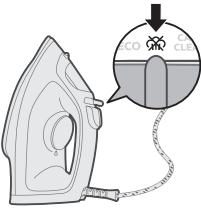

- 1** Buhar seçme düğmesini kaydırarak buharsız modu (kuru ütüleme) seçin.

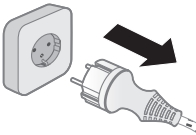

- 2** Cihazın fişini çekin.

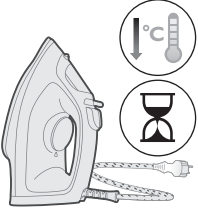

3 Cihazın soğumasını bekleyin.

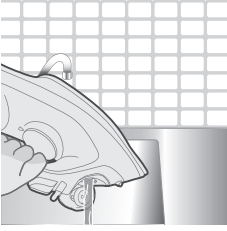

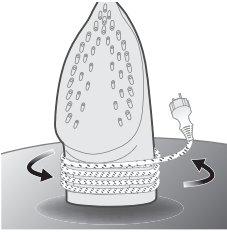

4 Su haznesinde kalan suyu boşaltın.



5 Güç kablosunu cihazın ana gövdesi etrafına sarın.

## Sorun giderme

Bu bölümde cihaz ile ilgili en sık karşılaşılan sorunlar özetlenmiştir. Sorunu aşağıdaki bilgilerle çözemezseniz sık sorulan sorular listesi için [www.philips.com/support](http://www.philips.com/support) adresini ziyaret edin veya ülkenizdeki Tüketici Destek Merkezi ile iletişime geçin.

Sorun	Olası neden	Çözüm
Ütü, kumaştaki kırışıklıkları gideremiyor.	Ütüleme sırasında buhar çıkmıyordu.	Su haznesini doldurun ve buhar düğmesini  konumuna getirin.
Cihaz buhar üretmiyor.	Haznede yeterli miktarda su yok.	Su haznesini doldurun.
	Buhar düğmesi  konumuna getirilmiştir.	Buhar düğmesini  konumuna getirin.
	Ütü buhar üretmek için henüz yeterli derecede sıcak değil.	Ütü ısınırken, "ütü hazır" ışığı sabit bir şekilde yanar. Ütü kullanıma hazır hale geldiğinde ışık söner.

Ütüleme sırasında su damlacıkları kumaşa damlıyor.	Püskürtme işlevini kısa bir süre içinde çok sık kullandınız.	Yatay konumda ütülemeye devam edin ve buhar püskürtme işlevini tekrar kullanmadan önce bir süre bekleyin.
	Su haznesi kapağı düzgün şekilde kapatılmamıştır.	"Klik" sesi duyana kadar kapağa bastırın.
Ütü buhar püskürtmüyor.	Buhar püskürtme işlevini kısa bir süre içinde çok sık kullandınız.	Yatay konumda ütülemeye devam edin ve buhar püskürtme işlevini tekrar kullanmadan önce bir süre bekleyin.
	Ütü, ütöleme işlemi için henüz yeterli derecede sıcak değil.	"Ütü hazır" ışığının yanıp sönmeye durup ışık sürekli yanana kadar bekleyin.
	Su haznesine bir kimyasal eklenmiştir.	Su haznesini su ile çalkalayın ve su haznesine parfüm veya başka bir kimyasal madde koymayın.
Ütünün fişi prizden çekildikten sonra tabandan su damlıyor.	Buhar düğmesi  konumuna getirilmiştir.	Buhar düğmesini  konumuna getirin.
	Su haznesinde su mevcutken ütü yatay konuma yerleştirilmiştir.	Kullanımdan sonra su haznesini boşaltın veya ütüyü dikey pozisyonda saklayın.
Ütü, kumaş üzerinde parlaklık veya iz bırakıyor.	Ütülenen yüzey düz değildir (örneğin dikişleri veya kumaş katını ütölediğiniz için).	Ütü, tüm ütölenebilir kumaşlarda güvenle kullanılabilir. Kumaş üzerindeki parlaklık veya iz geçicidir ve kumaş yıkandığında kaybolur. Dikişleri veya katları ütölemeyin. Ütünün iz bırakmasını önlemek için ütölenecek kısmın üzerine pamuklu bir bez koyabilirsiniz.

## Giriş

Satyn almagyňyz bilen gutlaýarys we Philips dünýäsine hoş geldiňiz! Philips tarapyndan hödürlenilýän goldawdan doly peýdalanmak üçin önümiňizi [www.philips.com/welcome](http://www.philips.com/welcome) salgysynda bellige aldyryň. Enjamy ulanmazdan ozal şu ulanyjy gollanmasyny, möhüm maglumat kagyzyňy we çalt başlangyç yolbeledini üns bilen okaň. Olary geljekde gollanmak üçin saklaň.

## Önüme umumy syn

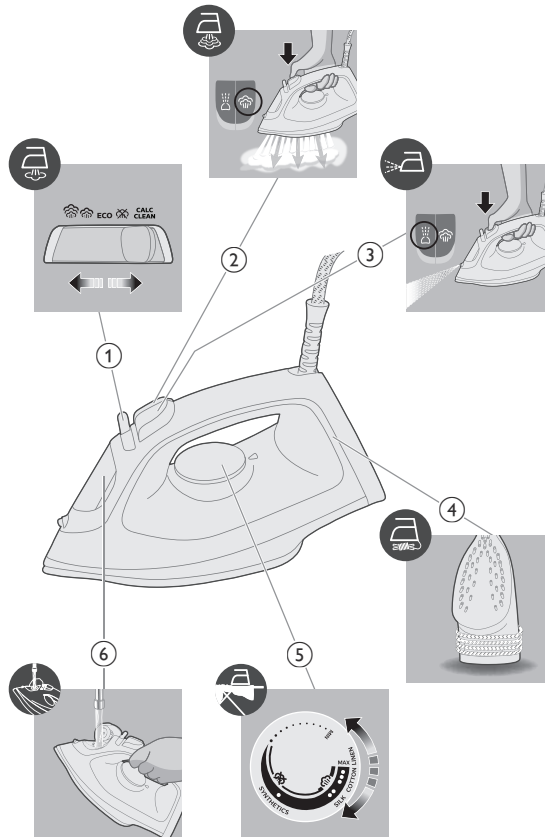



- 1 Bugy saýlaýjy
- 2 Bug güýçlendiriş düwmesi
- 3 Suw pürkme
- 4 Kabeli saramak
- 5 Temperaturany düzüş nurbady
- 6 Suw gabynyň gapagy

## Enjamy ulanmak

### Ulanýşa taýýarlamak

Bellik: Birinji gezek ulananyňyzda ütükden birneme bug çykmagy mümkin. Bu gysga wagtdan soň ýitirim bolar.

#### Ulanylmaly suwuň görnüşi

Enjamy agyz suw üpjünçiligi arkaly gelýän suw bilen ulanmak ýerlikli bolar. Emma, ýaşaýan ýeriňizde gaty suw bar bolsa, şäheriň suw ulgamyndan gelýän suw bilen distillirlenen ýa-da mineralsyzlaşdyrylan suwy deň möçberde goşmagyňyzy maslahat berýäris. Şeýtmek enjamda galyndylaryň çalt emele gelmeginiň öňüni alar we enjamyň ömrüni uzaldar.

**Ys beriji, guradyjy enjamdan çykan suw, sirke, krahmal, galyndyny aýyryýan serişdeler, ütük etmekde kömekçi serişdeler, himiki taýdan galyndysy aýrylan suw ýa-da başga himikatlary ulanmaň, sebäbi olar suwuň dammagyna, goňur tegmillere ýa-da enjamyňyza zeper ýetmegine sebäp bolup biler.**

### Suw gabyny doldurmak

- 1 Enjamy toga dakmaň.

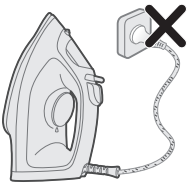

2 Enjamyň sowandygyna göz ýetiriň.

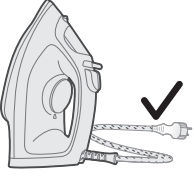

3 Bugsuz tertibi (gurulygyna ütüklemek) ~~ok~~ saýlamak üçin bugy saýlaýjyny saga süýşüriň.

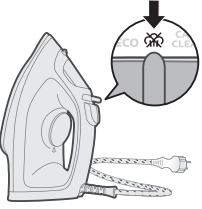

4 Suw gabynyň gapagyny dikläp açyň.

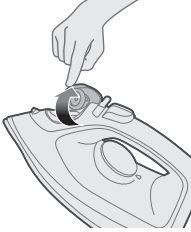

5 Suw gabyny suw gabyndaky MAX görkezijisine çenli dolduryň.

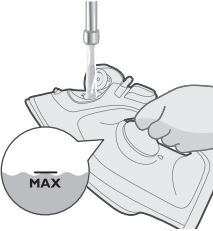

6 Suw gabynyň gapagyny berk ýapyň.

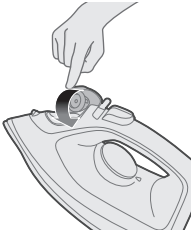

## Temperaturany sazlamak



	MAX ÇIT MATA	
	● ● ● PAGTA	
	● ● ÝÜPEK	<b>ECO</b>
	● SINTETIK	

ECO



ECO sazlamasy: Az ýygirtly geýimler üçin iň pes möçberde bug üznüksiz berilýär. Bu sazlamada energiýa hem tygşytlanylýar.



Iki bug buludy: Gaty ýygirtlar üçin has köp möçberde bug üznüksiz berilýär.



Üç bug buludy: Aýrylmasy kyn ýygirtlar üçin aňryçäk möçberde bug üznüksiz berilýär.

## Enjamy ulanmak

1 Nähili ütüklemelidigini görmek üçin geýimiň tagmasyny barlaň.

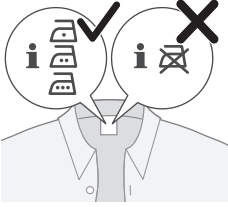

2 Temperatura nurbadyny ýerlikli temperatura görkezijisine aýlamak arkaly ütüklemegiň temperaturasyny düzüň.

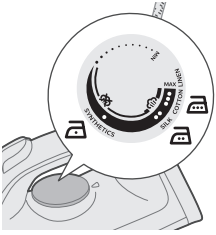

3 Ütügiň öz ökjesinde durmagyna maý beriň.

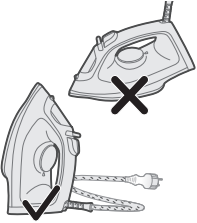

4 Enjamy topraga çatylan elektrik rozetkasyna dakyň.

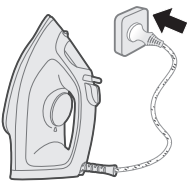

5 Ütügiň taýýardygyny görkezýän çyra ýanmak bilen enjamyň gyzýandygyny görkezýär.

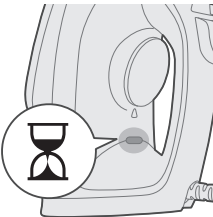

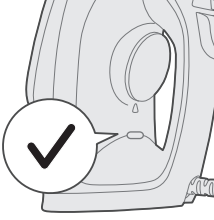

- 6 Ütügiň taýýardygyny görkezýän çyra öçeninde ütükläp başlamazdan oň birneme garaşyň. Ütüklenýän wagty taýýardygyny görkezýän çyra wagtal-wagtal ýanar.

## Bug ýok / Gury ütülemek

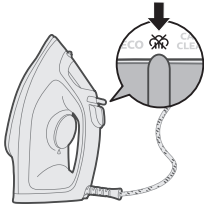

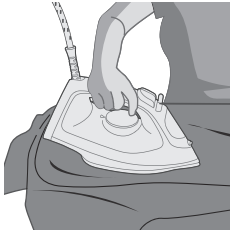

- 1 Bug sazlamasyny bug ýok sazlamasyna düzüň.

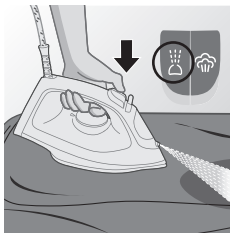

- 2 Biraz wagtdan soň ütüklenýärkä bug çykmary kesiler.

## Suw pürkme



- 1 Bug sazlamasyny bug ýok sazlamasyna düzüň. Aýrylmasy kyn ýygrytlary aýyrmak maksady bilen bug dumanyny emele getirmek üçin suw pürkme düwmesini  basyň.

## Güýçli bug

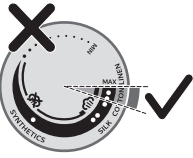

- 1 Temperatura nurbadyny pagta bilen çit matanyň arasyndaky MAX sazlamasyna düzň.

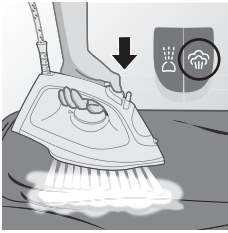

- 2 Aýrylmasy kyn ýygrytlary aýrmak maksady bilen güýçli bug bermek üçin güýçli bug beriş düwmesine basyp goýberň.

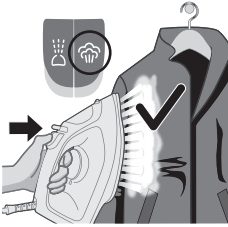

- 3 Asylygy duran eşiklerden, perdelerden we ş.m. ýygrytlary aýrmak üçin ütügi dik saklap güýçli bug bermek funksiýasyny ulanyp bilersiňiz (diňe DST2020 we DST2030 üçin).

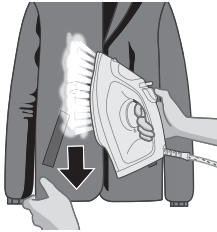

- 4 Aýrylmasy kyn ýygrytlary aýrmak üçin güýçli bug berilýärkä geýimiňizi çekiň we sozuň (diňe DST2020 we DST2030 üçin).



- 5 Bugy ulanýan wagtyňyz ýakaňaç eliňizi söýget tekizligi hökmünde ulanmaň.

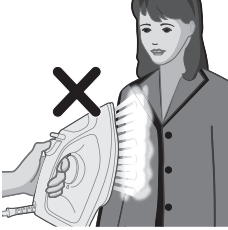

6 Enjamy özüňize/başga birine ýakyn ýerleşdirmäň.

## Awto-öçürmek (DST2030)

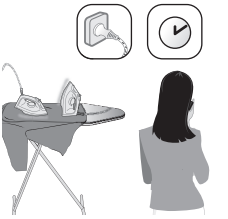

1 Kelläňiziň rahat bolmagy üçin enjamyňyz belli bir wagt gözegçiliksiz galdyrylan ýagdaýynda öz-özünden sowyayar.

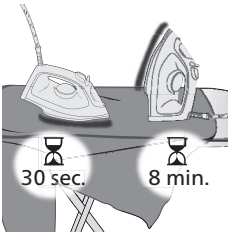

2 Enjam özüniň dabanynda durka 30 sekuntndan köp ulanylmasa ýa-da ökjesinde / esasynda durka 8 minutlap ulanylmasa, enjam awto-öçürmek tertibine geçýär.

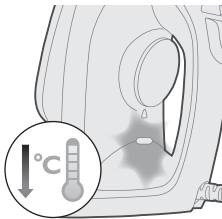

3 Awto-öçürmek tertibinde enjamyň temperaturasy peselýär. Enjamyň awto-öçüriş ýagdaýyndadygyny görkezmek üçin ütügiň taýýardygyny görkezýän çyra üzüksiz ýanyp-öçýär. Enjamy bütinleý öçürmek üçin enjamy rozetkadan aýryň.

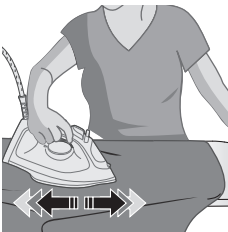

4 Enjamyň gaýtadan gyzmagy üçin ony ýerinden göteriň ýa-da çalaja süýşüriň.

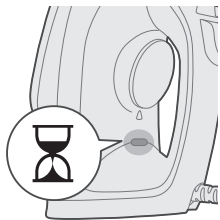

5 Ütügiň taýardygyny görkezýän çyra ýanmak bilen enjamyň gyzýandygyny görkezýär.

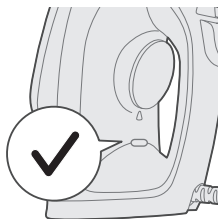

6 Ütügiň taýardygyny görkezýän çyra öçeninden soň enjam ulanyşa taýýar bolýar.

## Arassalamak we abatlamak

1 Enjamyň toga dakylmandygyna göz ýetiriň.

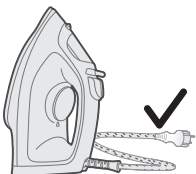
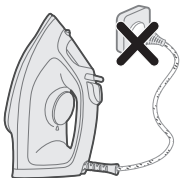

2 Enjamyň sowandygyna göz ýetiriň.

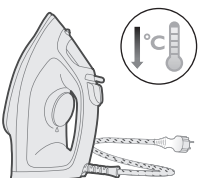



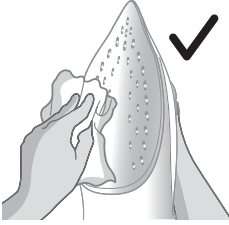

- 3 Ütügiň dabanynda galan übtükleri we islendik beýleki galyndylary çygly mata bilen süpürüp aýryň.



Bellik: Ütügiň dabanyny tekiz saklamak üçin onuň gaty metal narseler bilen galtaşmagynyň önüni alyň. Ütügiň dabanyny arassalamak üçin hiç haçan gazaw, sirke ýa-da beýleki himikatlary ulanmaň.



- 4 Enjamy krandan akýan suwda ýuwmaň / arassalamaň.

## Calc-Clean

Maslahat: Çökündileri çalt aýrmak funksiýasyny islendik wagt ulanyp bolýar. Ýaşayan sebitiňizdäki suw talh bolsa, funksiýany has ýygy ulanyň.



- 1 1 aý ulanylanyndan soň enjamyň ömrüni uzatmak we onuň gyzmagyny kepillendirmek üçin ýyganan çökündileri aýyrmagy ýerine ýetirmek maslahat berilýär.

## 466 Türkmençe

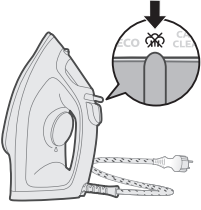

2 Ütügiň tokdan aýrylandygyna we bug sazlamasynyň bugsuz (gurulygyna ütükleme)  tertibine sazlanandygyna göz ýetiriň.

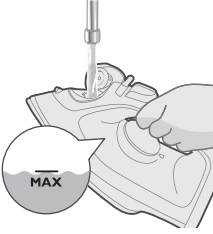

3 Suw gabyny MAX görkezijisine çenli dolduryň.



4 Temperatura nurbadyny MAX edip sazlaň.

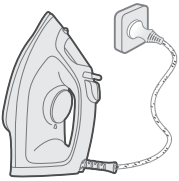

5 Enjamy topraga çatylan rozetka dakyň.

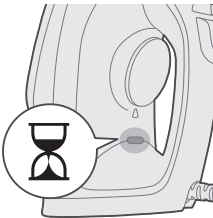

6 Ütügiň taýardygyny görkezýän çyra ýanmak bilen enjamyň gyzýandygyny görkezýär.

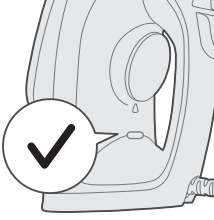

7 Ütügiň taýýardygyny görkezýän çyranyň öçmegine garaşyň.

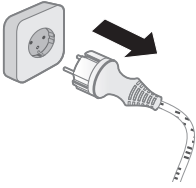

8 Ütügi tokdan aýryň.

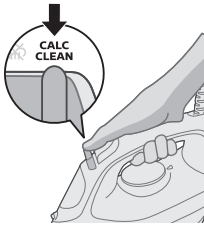

9 Bugy saýlaýjyny Calc-Clean ýagdaýyna süýşüriň we basyp saklaň.



10 Ütügi nowajygyň üstünde saklaň we ütügi emaç bilen silkiň. Dabanyndan gyzgyn suw we çökündi bölejikleri çykar.

Seresap boluň: Çökündiler ýuwulup aýrylýan wagty ütügiň dabanyndan bug we gaýnap duran suw hem çykýar.

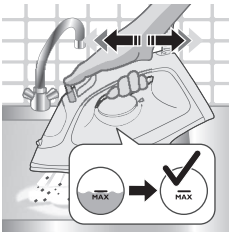

11 Suw gabyndaky suwuň hemmesi çykýança ütügi silkmäge dowam ediň.



12 Enjamy toga dakyň we dabanyňyň guramagy üçin enjamyň gyzmagyna maý beriň. Bu takmynan 2 minut wagt alýar.

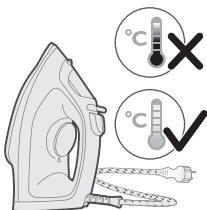

13 Ütügiň sowamagyna maý beriň.

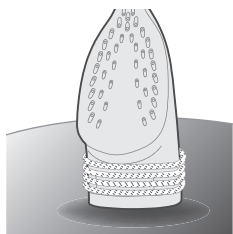

14 Elektrik kabelini ütügiň dabanyňyň daşyna saraň.

## Ammarda saklamak

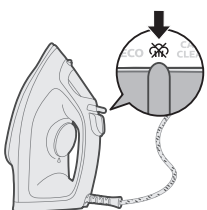

1 Bugsuz tertibi (gurulygyna ütüklemegi) ~~XXX~~ saýlamak üçin bugy saýlaýjyny süýşüriň.

2 Enjamy tokdan aýryň.

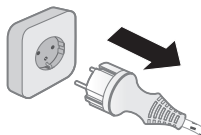

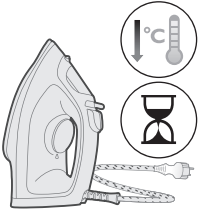

3 Enjamyň sowamagyna maý beriň.

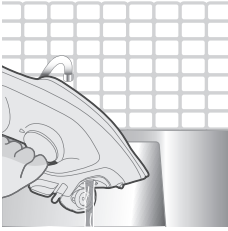

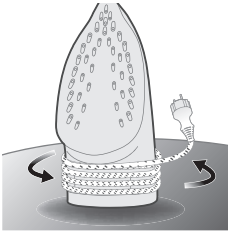

4 Suw gabynda galan suwy döküň.



5 Elektrik kabelini enjamyň esasy korpusynyň daşyna saraň.

## Näsazlyklary anyklaýyş

Bu bölümde enjamda öňüňize çykyp biljek umumy meseleler barada gysgaça maglumat berilýär. Aşakda berlen maglumatlar bilen meseläni çözüp bilmeseňiz, köp soralyan soraglaryň sanawyny görmek üçin [www.philips.com/support](http://www.philips.com/support) salgysyna giriň ýa-da ýurduňyzdaky Müşderiler bilen işleşmek boýunça merkeze ýüz tutuň.

Näsazlyk	Ähtimal sebäbi	Çözüň
Ütük eşikdäki ýygrytlary aýryp bilmeyär.	Ütük edilýän wagty bug berilmeyär.	Suw gabyny dolduryň we bugy açýan/ýapýan geçirgiji  ornuna geçiriň.
Ütükden hiç hili bug çykmaýar.	Gapda ýeterlik suw ýok.	Suw gabyny dolduryň.
	Bugy açýan/ýapýan geçirgiç  ýagdaýyna sazlanan.	Bugy açýan/ýapýan geçirgiji  ýagdaýyna sazlaň.

	Ütük bug öndürmek üçin ýeterlik gyzgyn däl.	Ütük gyzyp guran wagty "ütük taýýar" çyrasy ýanyp durýar. Ütük ulanyşa taýýar bolanynda çyra öçýär.
Ütük edilýän wagty geýimiň üstüne suw damjalary damýar.	Gysga wagtyň dowamynda güýçli bug bermek funksiýasyny çendenaşa ýgy ulanypsyňyz.	Kese ýagdaýda ütüklemäge dowam ediň we güýçli bug bermegi gaýtadan ulanmazdan ozal biraz garaşyň.
	Suw gabynyň gapagyny talabalaýyk ýapmansyňyz.	Tykgyldy sesini eşidýänçäňiz gapagy basyň.
Ütükden güýçli bug çykmaýar.	Gysga wagtyň dowamynda güýçli bug bermek funksiýasyny çendenaşa ýgy ulanypsyňyz.	Kese ýagdaýda ütüklemäge dowam ediň we güýçli bug bermegi gaýtadan ulanmazdan ozal biraz garaşyň.
	Ütük entek ütüklemek üçin ýeterlik gyzgyn däl.	"Ütügiň taýýardygyny görkezýän çyra" ýanyp-öçmegini bes edýänçä we birsyhly ýanyp durýança garaşyň.
	Suw gabyna himikat goşupsyňyz.	Suw gabyny ýuwuň we suw gabyna hiç hili ys beriji ýa-da himikat goşmaň.
Ütük tokdan aýrylanyndan soň ütügiň dabanyndan suw damýar.	Bugy açýan/ýapýan geçirgiç  ýagdaýyna sazlanan.	Bugy açýan/ýapýan geçirgiji  ýagdaýyna sazlaň.
	Suw gabnynda suw barka ütügi kese goýupsyňyz.	Ulananyňyzdan soň suw gabyny boşadyň ýa-da ütügi dik ýagdaýda goýuň.
Ütük geýimiň üstünde ýalpyldy ýa-da yz galdyrýar.	Ütüklenjek ýüz bitelik, mysal üçin geýimiň tikişini ýa-da epinini ütüklesiňiz.	Ütügi ütüklenmäge degişli ähli matalarda ulanmak howpsuz bolup durýar. Ýalpyldy ýa-da yz hemişelik bolman, olar, geýimi ýuwanyňyzda ýitýär. Tikişleri ýa-da epinleri ütüklemekden gaça duruň. Yz galmagynyň önüni almak üçin ütüklenjek ýeriň üstüne pagta mata goýup bilersiňiz.

## Εισαγωγή

Συγχαρητήρια για την αγορά σας και καλώς ήρθατε στη Philips! Για να επωφεληθείτε πλήρως από την υποστήριξη που προσφέρει η Philips, δηλώστε το προϊόν σας στη διεύθυνση [www.philips.com/welcome](http://www.philips.com/welcome). Διαβάστε προσεκτικά αυτό το εγχειρίδιο χρήσης, το φυλλάδιο σημαντικών οδηγιών και τον οδηγό γρήγορης έναρξης προτού χρησιμοποιήσετε τη συσκευή. Φυλάξτε τα για μελλοντική αναφορά.

## Επισκόπηση προϊόντος

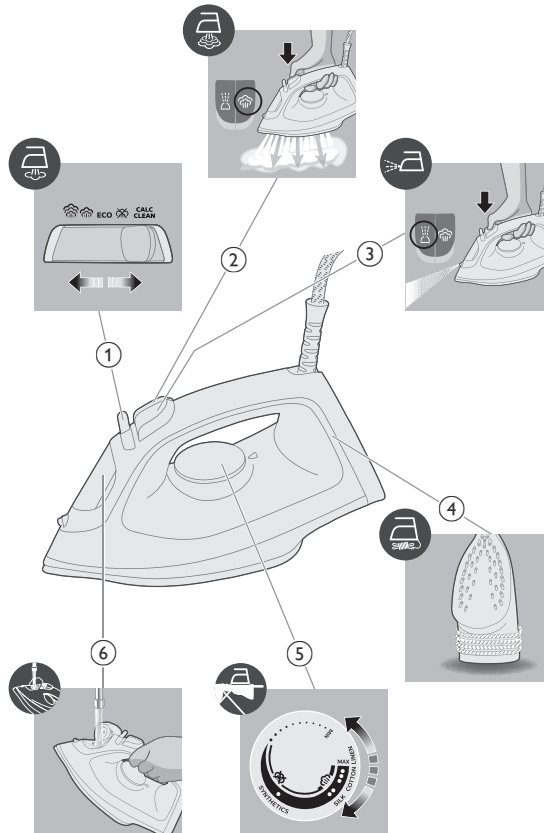

- 1 Επιλογέας ατμού
- 2 Κουμπί βολής ατμού
- 3 Ψεκασμός νερού
- 4 Σύστημα περιτύλιξης καλωδίου
- 5 Διακόπτης θερμοκρασίας
- 6 Καπάκι δοχείου νερού

## Χρήση της συσκευής

### Προετοιμασία για χρήση

**Σημείωση:** Το σίδερο μπορεί να βγάλει λίγο ατμό όταν το χρησιμοποιήσετε για πρώτη φορά. Αυτό σταματά μετά από λίγο.

#### Τύπος νερού για χρήση

Η συσκευή είναι κατάλληλη για χρήση με νερό βρύσης. Ωστόσο, αν ζείτε σε μια περιοχή με σκληρό νερό, σας συνιστούμε να αναμείξετε ίση ποσότητα νερού βρύσης με αποσταγμένο ή απιονισμένο νερό. Αυτό θα αποτρέψει την ταχεία συσσώρευση αλάτων και θα παρατείνει τη διάρκεια ζωής της συσκευής.

**Μην χρησιμοποιείτε άρωμα, το νερό από το στεγνωτήριο, ξύδι, κόλλα κολλαρίσματος, ουσίες αφαλάτωσης, υγρά σιδερώματος, χημικά αφαλατωμένο νερό ή άλλα χημικά, καθώς οι ουσίες αυτές ενδέχεται να προκαλέσουν διαρροή νερού, καφέ κηλίδες ή βλάβη στη συσκευή.**

### Γέμισμα του δοχείου νερού

- 1 Μην συνδέετε τη συσκευή στην πρίζα.

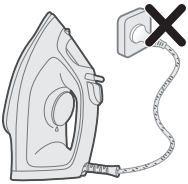



- 2 Βεβαιωθείτε ότι η συσκευή έχει κρυώσει.

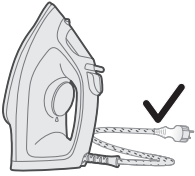

- 3 Σύρετε τον επιλογέα ατμού προς τα δεξιά, για να επιλέξετε τη λειτουργία χωρίς ατμό (στεγνό σιδέρωμα) ~~ατμό~~.

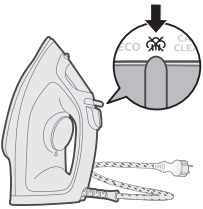

- 4 Ανοίξτε το καπάκι του δοχείου νερού.

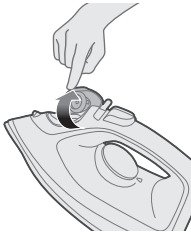

- 5 Γεμίστε το δοχείο νερού ως την ένδειξη MAX.

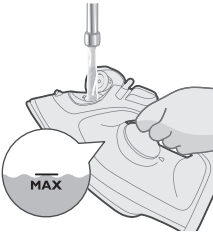

- 6 Κλείστε καλά το καπάκι του δοχείου νερού.

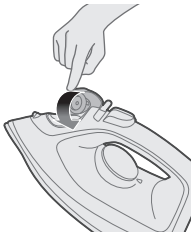

## Ρύθμιση της θερμοκρασίας



	MAX (ΜΕΓ.) LINEN (ΛΙΝΑ)	
	● ● ● COTTON (ΒΑΜΒΑΚΕΡΑ)	
	● ● SILK (ΜΕΤΑΞΩΤΑ)	<b>ECO</b>
	● SYNTHETICS (ΣΥΝΘΕΤΙΚΑ)	

**ECO**



Ρύθμιση ECO: Παρέχεται συνεχώς η ελάχιστη σταθερή ποσότητα ατμού για υφάσματα με λιγότερες τσακίσεις. Επίσης, αυτή η ρύθμιση εξοικονομεί ενέργεια.



Δύο σύννεφα ατμού: Παρέχεται συνεχώς περισσότερη ποσότητα ατμού για τις δύσκολες τσακίσεις.



Τρία σύννεφα ατμού: Παρέχεται συνεχώς η μέγιστη ποσότητα ατμού για τις επίμονες τσακίσεις.

## Χρήση της συσκευής

- 1 Ελέγξτε την ετικέτα του ρούχου για το απαιτούμενο σιδέρωμα.

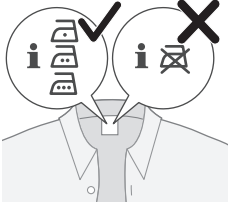

- 2 Ρυθμίστε τον διακόπτη θερμοκρασίας στην επιθυμητή θερμοκρασία σιδερώματος, γυρίζοντας τον προς την κατάλληλη ένδειξη.

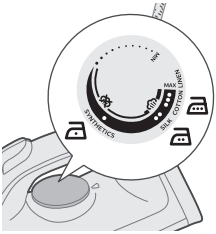

- 3 Αφήστε το σίδερο σε όρθια θέση.

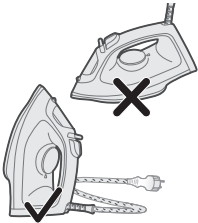

- 4 Συνδέστε τη συσκευή σε μια πρίζα με γείωση.

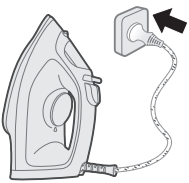

- 5 Η λυχνία ετοιμότητας του σίδηρου θα ανάψει, υποδεικνύοντας ότι το σίδερο θερμαίνεται.

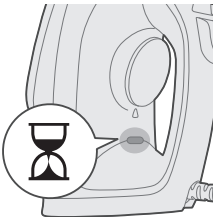

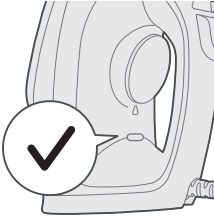

- 6 Όταν σβήσει η λυχνία ετοιμότητας σίδερου, περιμένετε λίγο πριν αρχίσετε το σιδέρωμα. Η λυχνία ετοιμότητας θα ανάβει κατά διαστήματα κατά τη διάρκεια του σιδερώματος.

## Χωρίς ατμό/Στεγνό σιδέρωμα

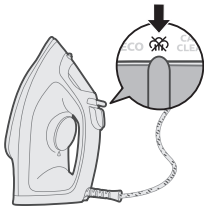

- 1 Θέστε τη ρύθμιση ατμού σε ρύθμιση χωρίς ατμό.

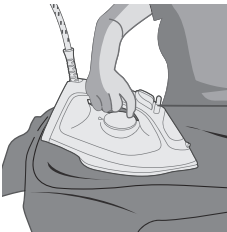

- 2 Μετά από λίγο, ο ατμός θα σταματήσει κατά τη διάρκεια του σιδερώματος.

## Ψεκασμός νερού



- 1 Θέστε τη ρύθμιση ατμού σε ρύθμιση χωρίς ατμό. Πατήστε στιγμιαία το κουμπί ψεκασμού νερού  για να βγει ένα σύννεφο ατμού που θα σας βοηθήσει να αφαιρέσετε τις επίμονες τσακίσεις.

## Βολή ατμού

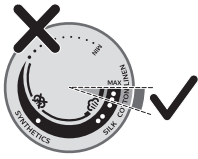

- 1 Ρυθμίστε τον διακόπτη θερμοκρασίας στη ρύθμιση MAX μεταξύ των ενδείξεων COTTON και LINEN.

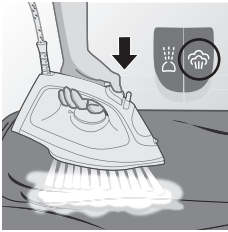

- 2 Πατήστε στιγμιαία το κουμπί βολής ατμού, για να εξαφανίσετε τις επίμονες τσακίσεις με μια ισχυρή βολή ατμού.

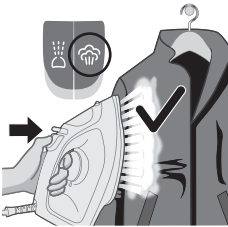

- 3 Μπορείτε να χρησιμοποιήσετε τη λειτουργία βολής ατμού ενώ κρατάτε το σίδερο σε κατακόρυφη θέση. Αυτό είναι χρήσιμο για να εξαφανίζετε τσακίσεις από κρεμασμένα ρούχα (μόνο για τα μοντέλα DST2020 και DST2030).

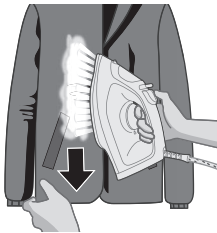

- 4 Τραβήξτε και τεντώστε το ρούχο ενώ χρησιμοποιείτε τη βολή ατμού, για να αφαιρέσετε τις επίμονες τσακίσεις (μόνο για τα μοντέλα DST2020 και DST2030).



- 5 Μην στηρίζετε το ρούχο πάνω στο γυμνό σας χέρι όταν σιδερώνετε.

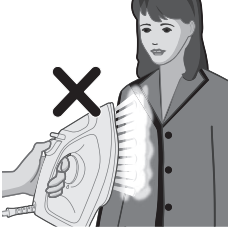

- 6 Μην στρέψετε τη συσκευή προς το μέρος σας ή προς οποιοδήποτε άλλο άτομο.

## Λειτουργία αυτόματης απενεργοποίησης (DST2030)

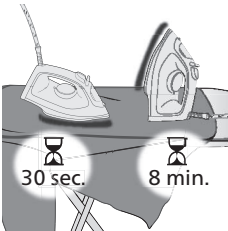
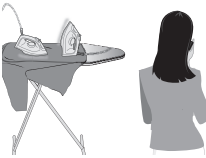

- 1 Για να είστε ήσυχoi, η συσκευή μπορεί να κρυώσει μόνη της αν την αφήσετε χωρίς επίβλεψη για μεγάλο χρονικό διάστημα.

- 2 Όταν η συσκευή δεν χρησιμοποιείται για περισσότερα από 30 δευτερόλεπτα όταν είναι ακουμπισμένη με την πλάκα κάτω ή για 8 λεπτά αφού τοποθετηθεί στη βάση ή σε όρθια θέση, μεταβαίνει στη λειτουργία αυτόματου τερματισμού λειτουργίας.

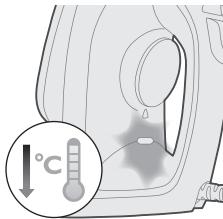

- 3 Στον αυτόματο τερματισμό λειτουργίας, η θερμοκρασία της συσκευής θα μειωθεί. Η λυχνία ετοιμότητας σίδερου επίσης θα αναβοσβήνει συνεχώς, για να υποδείξει ότι η συσκευή βρίσκεται σε κατάσταση αυτόματου τερματισμού λειτουργίας. Για να απενεργοποιήσετε πλήρως τη συσκευή, αποσυνδέστε την από την πρίζα.

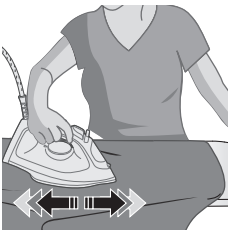

- 4 Για να ζεσταθεί ξανά η συσκευή, σηκώστε την ή μετακινήστε την ελαφρώς.

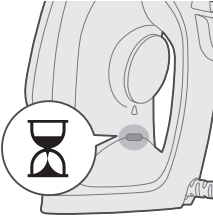

5 Η λυχνία ετοιμότητας του σίδερου θα ανάψει, υποδεικνύοντας ότι τη συσκευή θερμαίνεται.

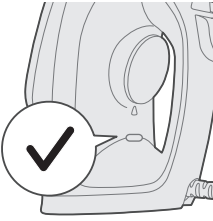

6 Μόλις σβήσει η λυχνία ετοιμότητας σίδερου, η συσκευή είναι έτοιμη για χρήση.

## Καθαρισμός και συντήρηση

1 Βεβαιωθείτε ότι η συσκευή δεν είναι συνδεδεμένη στη πρίζα.

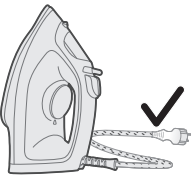
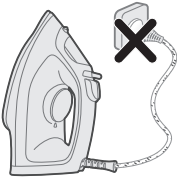

2 Βεβαιωθείτε ότι η συσκευή έχει κρυώσει.

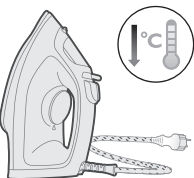

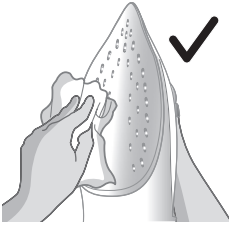

- 3 Σκουπίστε τις νιφάδες και άλλα υπολείμματα από την πλάκα με ένα υγρό πανί.



Σημείωση: Για να διατηρήσετε την πλάκα λεία, αποφύγετε την έντονη επαφή με μεταλλικά αντικείμενα. Μην χρησιμοποιείτε ποτέ συρμάτινα σφουγγαράκια, ξύδι ή άλλα χημικά για να καθαρίσετε την πλάκα του σιδήρου.



- 4 Μην πλένετε/καθαρίζετε τη συσκευή κάτω από τρεχούμενο νερό.

## Λειτουργία Αφαλάτωσης

Συμβουλή: Η λειτουργία Γρήγορης αφαλάτωσης μπορεί να χρησιμοποιηθεί οποιαδήποτε στιγμή. Αν ζείτε σε περιοχή με σκληρό νερό, πρέπει να χρησιμοποιείτε τη λειτουργία ακόμη πιο συχνά.



- 1 Μετά από 1 μήνα χρήσης, συνιστάται να εκτελέσετε τη λειτουργία για να αφαιρέσετε τα άλατα που έχουν συσσωρευτεί στη συσκευή, προκειμένου να παραταθεί η διάρκεια ζωής της και να θερμαίνεται σωστά.



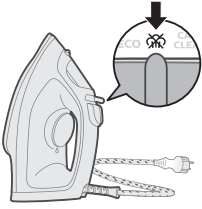

- 2 Βεβαιωθείτε ότι το σίδερο είναι αποσυνδεδεμένο από την πρίζα και ότι η ρύθμιση ατμού βρίσκεται στη λειτουργία χωρίς ατμό (στεγνό σιδέρωμα) .

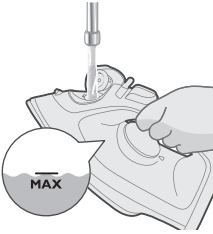

- 3 Γεμίστε το δοχείο νερού μέχρι την ένδειξη MAX.



- 4 Ρυθμίστε τον διακόπτη θερμοκρασίας στη θέση MAX.

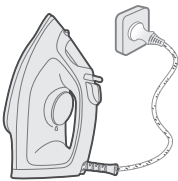

- 5 Συνδέστε τη συσκευή σε μια πρίζα με γείωση.

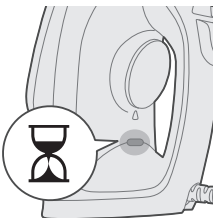

- 6 Η λυχνία ετοιμότητας του σιδερού θα ανάψει, υποδεικνύοντας ότι τη συσκευή θερμαίνεται.

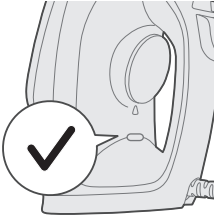

7 Περιμένετε μέχρι να σβήσει η λυχνία ετοιμότητας σίδερου.

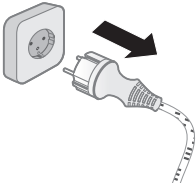

8 Αποσυνδέστε το σίδερο από την πρίζα.

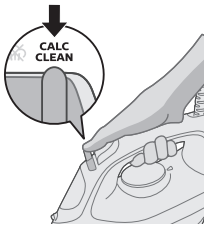

9 Μετακινήστε τον επιλογή ατμού στη θέση καθαρισμού αλάτων (Calc-Clean) και διατηρήστε τον εκεί.



10 Κρατήστε το σίδερο πάνω από τον νεροχύτη και ανακινήστε το ήπια. Από την πλάκα θα βγει καυτό νερό και σωματίδια αλάτων.

Προσοχή: Καθώς απομακρύνονται τα άλατα, βγαίνει επίσης ατμός και βραστό νερό από την πλάκα.

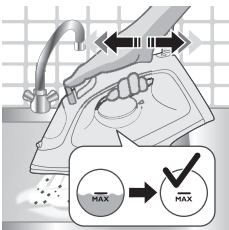

11 Συνεχίστε να ανακινείτε το σίδερο ώσπου να αδειάσει όλο το νερό από το δοχείο νερού.

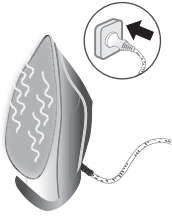

**12** Συνδέστε τη συσκευή στην πρίζα και αφήστε τη να ζεσταθεί για να στεγνώσει η πλάκα. Η διαδικασία αυτή διαρκεί περίπου 2 λεπτά.

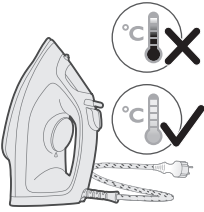

**13** Αφήστε το σίδερο να κρυώσει.

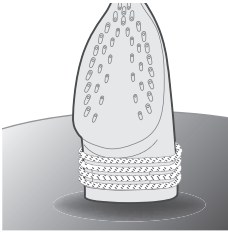

**14** Τυλίξτε το καλώδιο γύρω από τη βάση του σιδερού.

## Αποθήκευση

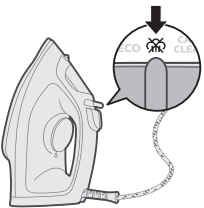

**1** Σύρετε τον επιλογέα ατμού για να επιλέξετε τη λειτουργία χωρίς ατμό (στεγνό σιδέρωμα) ~~ατμό~~.

**2** Αποσυνδέστε τη συσκευή από την πρίζα.

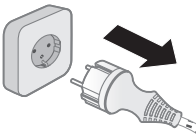

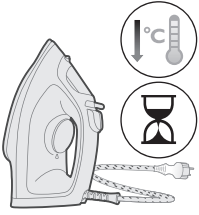

3 Αφήστε τη συσκευή να κρυώσει.

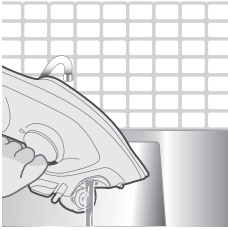

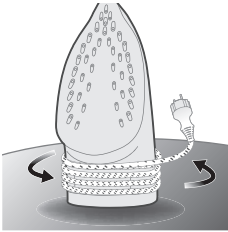

4 Αδειάστε το νερό που έχει απομείνει στο δοχείο νερού.



5 Τυλίξτε το καλώδιο ρεύματος γύρω από το κύριο σώμα της συσκευής.

## Αντιμετώπιση προβλημάτων

Σε αυτό το κεφάλαιο συνοψίζονται τα πιο συνήθη προβλήματα που μπορεί να αντιμετωπίσετε με τη συσκευή. Αν δεν μπορέσετε να λύσετε το πρόβλημα με τις παρακάτω πληροφορίες, ανατρέξτε στη λίστα συχνών ερωτήσεων στη διεύθυνση [www.philips.com/support](http://www.philips.com/support) ή επικοινωνήστε με το Κέντρο Εξυπηρέτησης Καταναλωτών στη χώρα σας.

Πρόβλημα	Πιθανή αιτία	Λύση
Το σίδερο δεν μπορεί να αφαιρέσει τις τσακίσεις από τα ρούχα.	Δεν παράγεται ατμός κατά τη διάρκεια του σιδερώματος.	Γεμίστε το δοχείο νερού και ρυθμίστε το διακόπτη ατμού στη θέση  .
Το σίδερο δεν παράγει καθόλου ατμό.	Δεν υπάρχει αρκετό νερό στο δοχείο.	Γεμίστε το δοχείο νερού.
	Ο διακόπτης ατμού έχει ρυθμιστεί στη θέση  .	Ρυθμίστε το διακόπτη ατμού στη θέση  .

	Το σίδηρο δεν έχει θερμανθεί αρκετά ακόμα ώστε να παραγάγει ατμό.	Ενώ το σίδηρο θερμαίνεται, η λυχνία ετοιμότητας σίδηρου ανάβει σταθερά. Όταν το σίδηρο είναι έτοιμο για χρήση, η λυχνία σβήνει.
Σταγόνες νερού στάζουν πάνω στο ύφασμα κατά τη διάρκεια του σιδερώματος.	Έχετε χρησιμοποιήσει τη λειτουργία βολής ατμού πολύ συχνά μέσα σε μικρό χρονικό διάστημα.	Συνεχίστε το σιδέρωμα σε οριζόντια θέση και περιμένετε λίγο πριν χρησιμοποιήσετε ξανά τη λειτουργία βολής ατμού.
	Δεν έχετε κλείσει σωστά το καπάκι του δοχείου νερού.	Πιέστε το καπάκι μέχρι να ακούσετε ένα "κλικ".
Το σίδηρο δεν παράγει βολή ατμού.	Χρησιμοποιήσατε τη λειτουργία βολής ατμού πολλές φορές μέσα σε μικρό χρονικό διάστημα.	Συνεχίστε το σιδέρωμα σε οριζόντια θέση και περιμένετε λίγο πριν χρησιμοποιήσετε ξανά τη λειτουργία βολής ατμού.
	Το σίδηρο δεν είναι αρκετά ζεστό ακόμα για να σιδερώσετε.	Περιμένετε μέχρι η λυχνία ετοιμότητας σίδηρου να σταματήσει να αναβοσβήνει και να είναι σταθερά αναμμένη.
	Έχετε προσθέσει κάποια χημική ουσία στο δοχείο ατμού.	Ξεπλύνετε το δοχείο νερού και μην ρίξετε αρωματικά ή άλλα χημικά μέσα σε αυτό.
Στάζει νερό από την πλάκα μετά την αποσύνδεση του σίδηρου από την πρίζα.	Ο διακόπτης ατμού έχει ρυθμιστεί στη θέση  .	Ρυθμίστε το διακόπτη ατμού στη θέση  .
	Τοποθετήσατε το σίδηρο σε οριζόντια θέση ενώ είχε παραμείνει νερό μέσα στο δοχείο νερού.	Αδειάστε το δοχείο νερού μετά τη χρήση ή αποθηκεύστε το σίδηρο σε κάθετη θέση.
Το σίδηρο αφήνει γυαλάδα ή σημάδια επάνω στο ρούχο.	Η επιφάνεια που σιδερώθηκε ήταν ανομοιόμορφη, για παράδειγμα το σιδέρωμα έγινε πάνω από ραφή ή πτυχή του ρούχου.	Το σίδηρο μπορεί να χρησιμοποιηθεί με ασφάλεια σε όλα τα υφάσματα που σιδερώνονται. Οι γυαλάδες και τα σημάδια δεν μένουν μόνιμα και θα εξαφανιστούν όταν πλύνετε το ύφασμα. Αποφεύγετε να σιδερώνετε πάνω από ραφές ή πτυχές. Εναλλακτικά, μπορείτε να τοποθετήσετε ένα βαμβακερό πανί πάνω στην περιοχή που θα σιδερωθεί, ώστε να μην δημιουργηθούν σημάδια.

## Въведение

Поздравления за покупката и добре дошли във Philips! За да се възползвате изцяло от предлаганата от Philips поддръжка, регистрирайте продукта си на [www.philips.com/welcome](http://www.philips.com/welcome). Прочетете това ръководство за потребителя, листовката с важна информация и ръководство за бърз старт внимателно, преди да използвате уреда. Запазете ги за бъдеща справка.

## Общ преглед на продукта

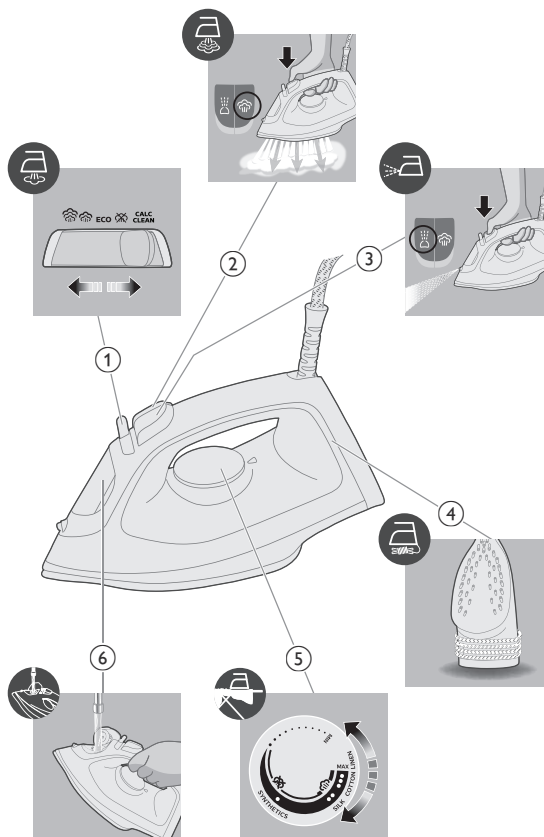

- 1 Селектор за настройка на пара
- 2 Бутон за допълнителна пара
- 3 Водна струя
- 4 Място за навиване на кабела
- 5 Температурен регулатор
- 6 Капак на водния резервоар

## Използване на уреда

### Подготовка за употреба

Забележка: От ютията може да излезе малко пара, когато я използвате за първи път. Това спира след кратко време.

#### Тип вода за използване

Уредът е подходящ за използване с чешмяна вода. Ако обаче живеете в зона с твърда вода, препоръчваме да смесите равно количество чешмяна вода с дестилирана или деминерализирана вода. Това ще предотврати бързото натрупване на накип и ще удължи живота на уреда.

**Не добавяйте парфюм, вода от сушилна машина, оцет, нишесте, препарати за отстраняване на котлен камък, помощни препарати за гладене, химически декалцирана вода или други химикали, тъй като те могат да причинят изхвърляне на вода, кафяво оцветяване или повреда на вашия уред.**

### Пълнене на водния резервоар

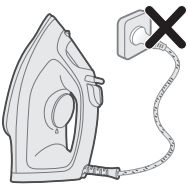

- 1 Не включвайте щепсела на уреда в контакта.

2 Уверете се, че уредът се е охладил.

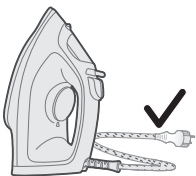

3 Плъзнете селектора за настройка на парата надясно, за да изберете режим без пара (сухо гладене) ~~☒~~.

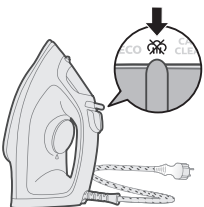

4 Отворете капачето на водния резервоар.

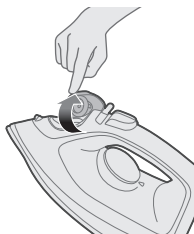

5 Напълнете водния резервоар до знака MAX в него.

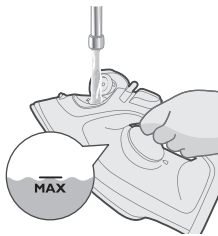

6 Затворете плътно капачето на водния резервоар.

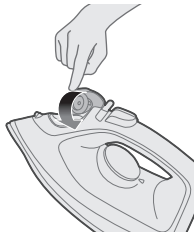



## Настройване на температурата



	МАХ ЛЕН	
	● ● ● ПАМУК	
	● ● КОПРИНА	<b>ECO</b>
	● СИНТЕТИКА	

ECO



ECO настройка: Минимална постоянна пара се доставя непрекъснато за дрехи с по-малко гънки. Тази настройка също така пести електроенергия.



Две облачета пара: Повече постоянна пара се доставя непрекъснато за най-упоритите гънки.



Три облачета пара: Максимална постоянна пара се доставя непрекъснато за най-упоритите гънки.

## Използване на уреда

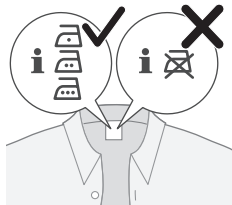

1 Проверете етикета на дрехата за необходимия метод на гладене.

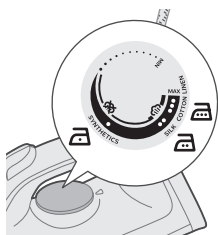

2 Нагласете регулатора на температурата на нужната температура на гладене, като го завъртите на съответната стойност.

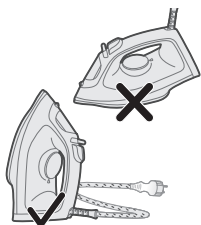

3 Оставете ютията да стои върху петата си.

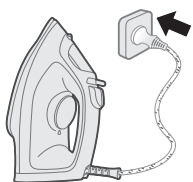

4 Включете уреда в заземен електрически контакт.

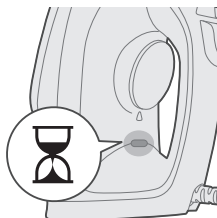

5 Индикаторът за готовност на ютията ще светне, което означава, че ютията се нагрява.

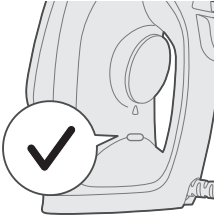

- 6 Когато светлинният индикатор за готовност на ютията изгасне, изчакайте малко, преди да започнете да гладите. Светлинният индикатор за готовност ще светва от време на време по време на гладене.

## Гладене без пара/сухо гладене

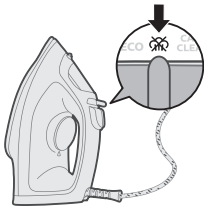

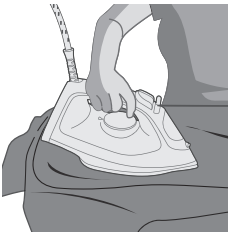

- 1 Задайте настройката за пара на гладене без пара.

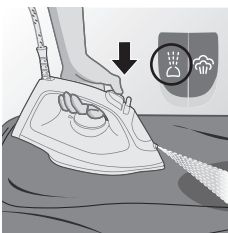

- 2 След кратко време парата ще спре по време на гладенето.

## Водна струя



- 1 Задайте настройката за пара на гладене без пара. Натиснете и отпуснете бутона за пръскане на вода , за да се появи струя за отстраняване на упорити гънки.

## Парен удар

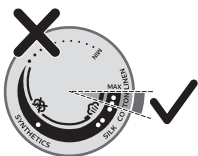

- 1 Задайте регулатора на температурата на MAX стойност между памук и лен.



- 2 Натиснете и освободете бутона за парен удар, за да генерирате мощна пара, която премахва упоритите гънки.



- 3 Можете да използвате функцията за допълнителна пара, когато държите ютията вертикално, за да изгладите висящи дрехи (само за DST2020 и DST2030).

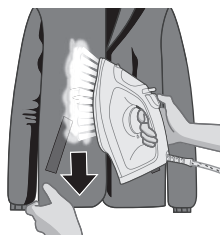

- 4 Издърпвайте и разтягайте дрехата, докато прилагате пара, за да премахнете упоритите гънки (само за DST2020 и DST2030).



- 5 Не използвайте голата си ръка за опора, когато гладите.

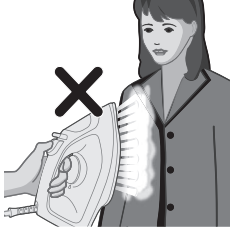

- 6 Не насочвайте уреда към себе си/друг човек.

## Автоматично изключване (DST2030)



- 1 За да сте спокойни, уредът ще се охлади сам, ако е оставен без надзор за определен период от време.

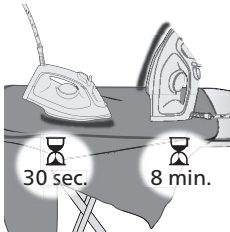
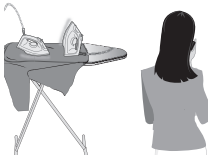

- 2 Когато уредът не се използва за повече от 30 секунди, когато е поставен върху гладещата повърхност, или за 8 минути, когато е поставен върху петата/основата, уредът ще влезе в режим на автоматично изключване.

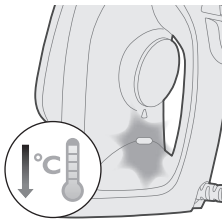

- 3 Температурата на уреда ще се понижи в режим на автоматично изключване. Светлинният индикатор за готовност на ютията също ще мига без прекъсване, за да покаже, че уредът е в състояние на автоматично изключване. За да изключите напълно уреда, изключете го от контакта.

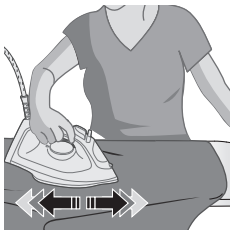

- 4 За да оставите уреда да се нагрее отново, вдигнете го или леко го раздвижете.

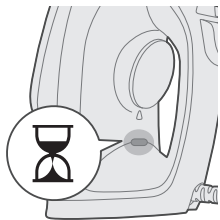

5 Индикаторът за готовност на ютията ще светне, което означава, че уредът се нагрява.

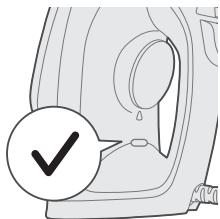

6 След като индикаторът за готовност на ютията се изключи, уредът е готов за употреба.

## Почистване и поддръжка

1 Уверете се, че уредът не е включен в контакта.

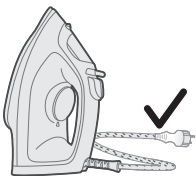
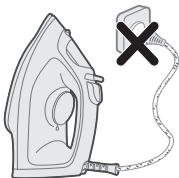

2 Уверете се, че уредът се е охладил.

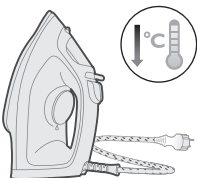

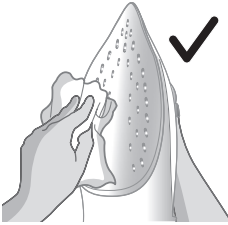

- 3 Избършете люспите и другите отлагания от гладещата повърхност с влажна кърпа.



Забележка: За да запазите гладещата повърхност от издраскване, избягвайте груб допир до метални предмети. Никога не използвайте тел, оцет или други химикали за почистване на гладещата повърхност.



- 4 Не мийте/почиствайте уреда под течаща вода.

## Calc-Clean

Съвет: Функцията за бързо премахване на накип може да се използва по всяко време. В случай че живеете в област с твърда вода, използвайте функцията по-често.



- 1 След 1 месец употреба се препоръчва да извършите почистване на накип, за да отстраните натрупания от уреда котлен камък, за да удължите живота му и да гарантирате, че ще загрее.

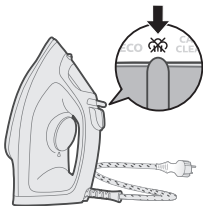

2 Уверете се, че ютията е изключена от контакта и настройката за пара е зададена на режим на гладене без пара (сухо гладене) .

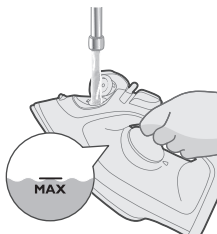

3 Напълнете водния резервоар до знака MAX.

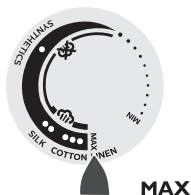

4 Нагласете температурния регулатор на MAX.

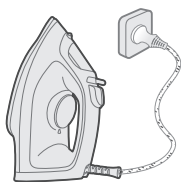

5 Включвайте уреда само в заземен електрически контакт.

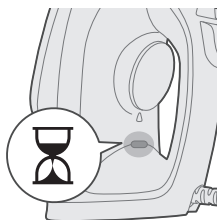

6 Индикаторът за готовност на ютията ще светне, което означава, че уредът се нагрива.



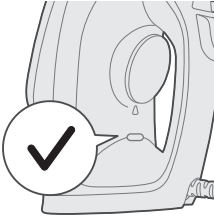

7 Изчакайте светлината за готовност на ютията да угасне.

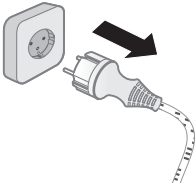

8 Изключете ютията от електрическия контакт.

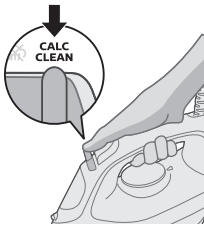

9 Плъзнете селектора за настройка на парата в позиция Calc-Clean и го задръжте.



10 Дръжте ютията над мивката и леко я разклатете. От гладещата повърхност ще започне да се отделя гореща вода и частици варовик.

Внимание: Заедно с накипа, от гладещата повърхност излизат пара и гореща вода.

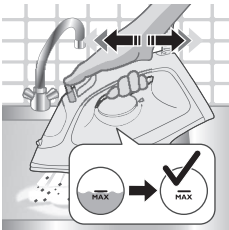

11 Продължавайте да разклащате ютията, докато се освободи всичката вода във водния резервоар.

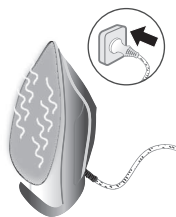

**12** Включете уреда в захранването и го оставете да загрее, за да подсуши гладещата повърхност. Това отнема около 2 минути.

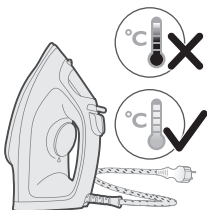

**13** Оставете ютията да се охлади.

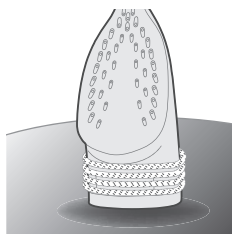

**14** Навийте кабела около петата на уреда.

## Съхранение

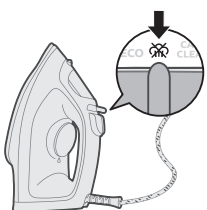

**1** Плъзнете селектора за настройка на парата, за да изберете режим без пара (сухо гладене) ~~пар~~.

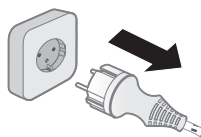

**2** Изключете уреда от контакта.

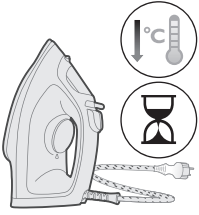

3 Оставете уреда да изстине.

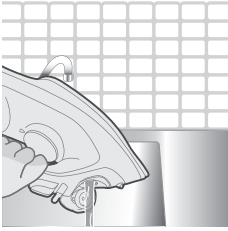

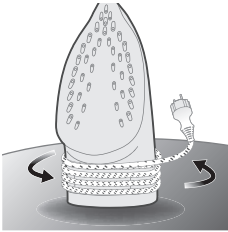

4 Излейте останалата вода от водния резервоар.



5 Навийте захранващия кабел около корпуса на уреда.

## Отстраняване на неизправности

В тази глава са обобщени най-често срещаните проблеми, на които можете да се натъкнете при ползване на уреда. Ако не можете да разрешите проблема с помощта на информацията по-долу, посетете [www.philips.com/support](http://www.philips.com/support) за списък с често задавани въпроси или се свържете с центъра за обслужване на потребители във вашата държава.

Проблем	Възможна причина	Решение
Ютията не може да премахна гънките на дрехата.	Няма пара по време на гладене.	Напълнете резервоара за вода и поставете регулатора на парата в плъзгача в положение  .
Ютията не подава пара.	В резервоара няма достатъчно вода.	Напълнете водния резервоар.
	Плъзгачът за пара е нагласен в положение  .	Поставете плъзгача за пара в положение  .

	Ютията не е достатъчно гореща, за да подава пара.	Когато ютията се нагрива, светлинният индикатор за готовност за ютията свети постоянно. Когато ютията е готова за използване, светлинният индикатор изгасва.
Капчици вода падат върху дрехата по време на гладене.	Използвали сте функцията за допълнителна пара твърде често за кратък период от време.	Продължете гладенето в хоризонтално положение и изчакайте малко, преди да използвате отново функцията за допълнителна пара.
	Не сте затворили добре капака на резервоара за вода.	Натиснете капачката, докато чуete щракване.
Ютията не произвежда допълнителна пара.	Използвали сте функцията за допълнителна пара твърде често за кратък период от време.	Продължете гладенето в хоризонтално положение и изчакайте малко, преди да използвате отново функцията за допълнителна пара.
	Ютията не е достатъчно гореща за гладене все още.	Изчакайте, докато светлинният индикатор за готовност на ютията спре да мига и светва за постоянно.
	Сложили сте химикал в резервоара за вода.	Изплакнете резервоара за вода и не наливайте в него парфюм или химикали.
От гладещата плоча капе вода, след като ютията е изключена от контакта.	Плъзгачът за пара е нагласен в положение  .	Поставете плъзгача за пара в положение  .
	Поставили сте ютията в хоризонтално положение, а в резервоара все още има вода.	Изпразнете резервоара за вода след употреба или съхранявайте ютията във вертикално положение.
Ютията оставя лъскави места и отпечатащи от шевове върху дрехата.	Гладили сте върху неравна повърхност, например шев или гънка на дрехата.	Ютията е безопасна за използване на всички подходящи за гладене дрехи. Блясъкът или отпечатакът не е постоянен и изчезва, когато изперете дрехата. Избягвайте гладене над шевовете или плисетата. Можете също да поставите памучна кърпа върху зоната, която ще гладите, за да се избегнат отпечатащи.

## Киришүү

Сатып алганыңыз үчүн куттуктайбыз жана Philips'ке кош келиңиз! Philips сунуштаган колдоону толук пайдалануу үчүн өнүмүңүздү [www.philips.com/welcome](http://www.philips.com/welcome) баракчасынан каттоодон өткөрүңүз. Шайманды колдонуудан мурун, колдонуучунун нускамасын, маанилүү маалымат китепчесин жана тез баштоо көрсөтмөсүн кунт коюп окуп чыгыңыз. Аларды келечекте колдонуу үчүн сактап коюңуз.

## Өнүмдүн кыскача сүрөттөлүшү

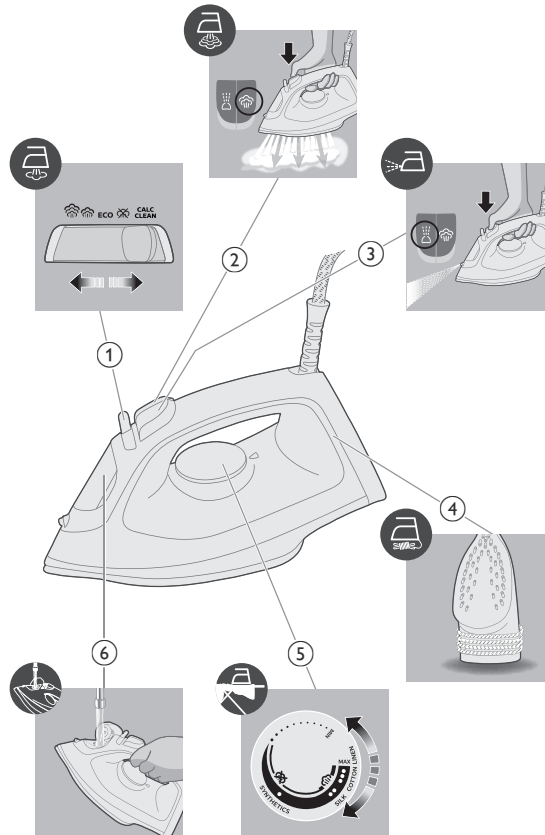

- 1 Буу режимин тандоо
- 2 Бууну күчөтүү баскычы
- 3 Суу чачуу
- 4 Шнур орому
- 5 Температура тергич
- 6 Суу челегинин капкагы

## Шайманды колдонуу

### Колдонууга даярдоо

Эскертүү: Үтүктү биринчи жолу колдонуп жатканда андан бир аз буу чыгышы мүмкүн. Ал бир аздан кийин жоголуп кетет.

#### Колдонула турган суунун түрү

Шайманды крандагы суу менен колдонууга болот. Ошентсе да, эгер катуу суу аккан аймакта жашасаңыз, кран суусу менен тузсуздандырылган же деминералдаштырылган сууну бирдей өлчөмдө аралаштырууну сунуштайбыз. Бул таштын уюп калышынан сактап, шаймандын иштөө мөөнөтүн узартат.

**Атыр, кургаткычтан сыгылган суу, уксус, крахмал, кебээр кетирүүчү каражат, үтүктөө каражаттары, химиялык жол менен тазаланган суу же башка химикаттарды колдонбоңуз. Анткени алар суунун тамчылашына, күрөң тактын калышына же шаймандын бузулушуна алып келиши мүмкүн.**

### Суу челегин толтуруу

- 1 Шайманды электр тармагына туташтырбаңыз.

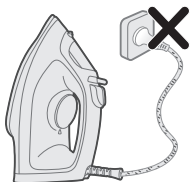

2 Өнүмдүн муздаганын текшериниз.

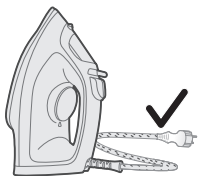

3 Буусуз режимин тандоо үчүн буу режимин оңго жылдырыңыз (куркак үтүктөө) ~~OFF~~.

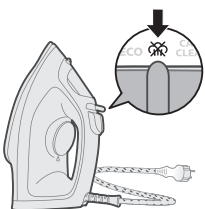

4 Суу челегинин капкагын ачыңыз.

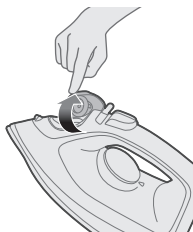

5 Суу челегин MAX белгисине чейин толтуруңуз.

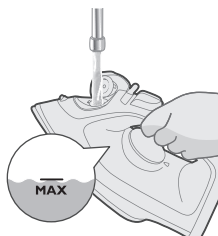

6 Суу челегинин капкагын бекем жабыңыз.

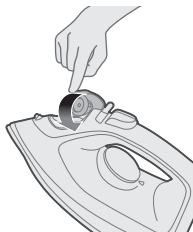

## Температураны жөндөө



	МАКС ЗЫГЫР БУЛАСЫ	
	● ● ● ПАХТА	
	● ● ЖИБЕК	<b>ECO</b>
	● СИНТЕТИКА	

ECO



ECO режими: Бырыштары аз кийимдер үчүн минималдуу, туруктуу буу үзгүлтүксүз берилет. Бул жөндөө энергияны дагы үнөмдөйт.



Эки буу агымы: Катуу бырыштарды кетирүүдө токтоосуз буу үзгүлтүксүз түрдө чыгат.



Үч буу агымы: Өтө катуу бырыштарды кетирүүдө максималдуу, токтоосуз буу үзгүлтүксүз түрдө чыгат.



## Шайманды колдонуу

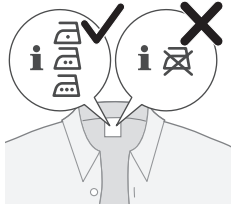

1 Үтүктөө көрсөтмөлөрүн көрүү үчүн кийимдин этикеткасын текшериңиз.

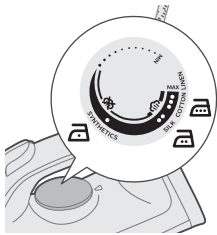

2 Температура тергичин тиешелүү температура көрсөткүчүнө буруп, талап кылынган үтүктөө температурасына коюңуз.

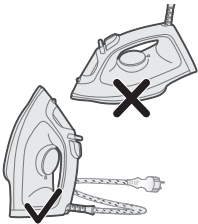

3 Үтүктү тургузуп коюңуз.

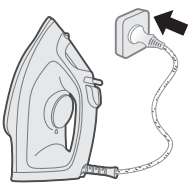

4 Электр сайгычын жерге туташтырылган розеткага сайыңыз.

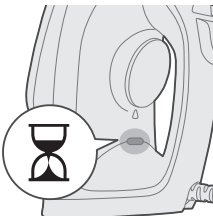

5 "Үтүк даяр" көрсөткүчү күйүп, үтүк ысып жатканын көрсөтөт.

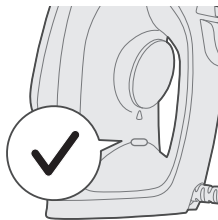

- 6 "Үтүк даяр" көрсөткүчү өчкөн соң, үтүктөөнү баштаардан мурун бир аз күтө туруңуз. "Даяр" көрсөткүчү үтүктөө учурунда мезгил-мезгили менен жанып турат.

## Буусуз/Кургак үтүктөө

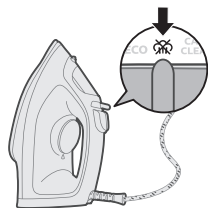

- 1 Буу режимин буусуз режимине коюңуз.

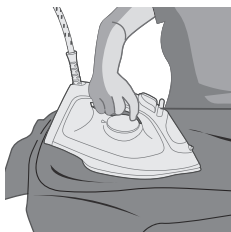

- 2 Бир аз убакыт өткөндөн кийин үтүктөө учурунда буу токтойт.

## Суу чачуу



- 1 Буу режимин буусуз режимине коюңуз. Өтө катуу бырыштарды суу агымы менен кетирүү үчүн суу чачуу баскычын  басып, кое бериңиз.

## Бууну күчөтүү

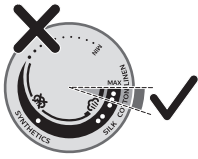

- 1 Температура тергичин пахта менен зыгыр буласынын ортосундагы MAX режимине коюңуз,.

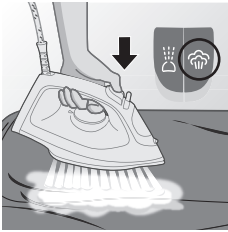

- 2 Өтө катуу бырыштарды кетирүү үчүн бууну күчөтүү баскычын басып, кое бериңиз.

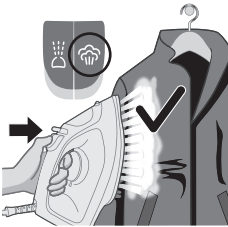

- 3 Үтүктү тик абалда кармап, илинген кийимдерден бырыштарды кетирүү үчүн бууну күчөтүү функциясын колдоно аласыз (DST2020 жана DST2030 үчүн гана).

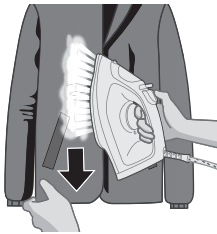

- 4 Өтө катуу бырыштарды кетирүү үчүн бууну күчөтүү учурунда кийимиңизди тартыңыз жана чоюңуз (DST2020 жана DST2030 үчүн гана).



- 5 Үтүктөп жатканда эч качан ачык колуңузду таяныч жер катары колдонбоңуз.

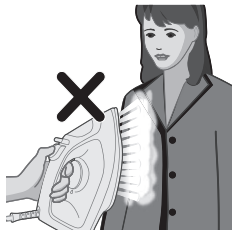

6 Буулагычты өзүңүзгө/башка адамга каратпаңыз.

## Автоматтык түрдө өчүү режимин (DST2030)



1 Жан дүйнөңүзгө тынчтык берүү үчүн, шайман бир азга кароосуз калса, өзүнөн өзү муздайт.

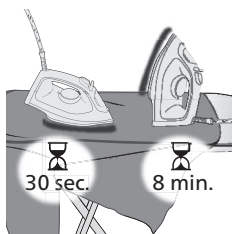

2 Шайман 30 секундтан ашык таманы менен же 8 мүнөт согончогуна/негизине тургузуп коюп, колдонулбаса, шайман автоматтык түрдө өчүү режимине өтөт.

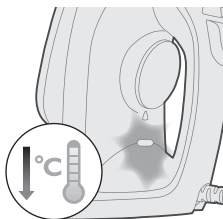

3 Автоматтык өчүү режиминде шаймандын температурасы төмөндөйт. "Үтүк даяр" көрсөткүчү токтоосуз өчүп-күйүп, шайман автоматтык түрдө өчүү режимде экенин билдирет. Шайманды толугу менен өчүрүү үчүн, шайманды розеткадан сууруп салыңыз.

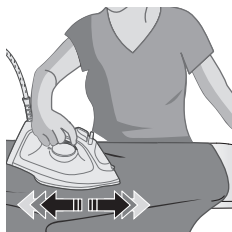

4 Шайманды кайра ысытуу үчүн, аны көтөрүңүз же акырын жылдырыңыз.

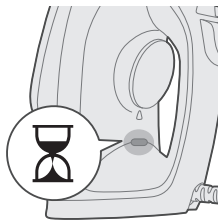

5 "Үтүк даяр" көрсөткүчү күйүп, шайман ысып жатканын көрсөтөт.

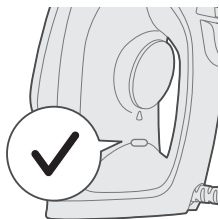

6 "Үтүк даяр" көрсөткүчү өчкөндөн кийин, шайман колдонууга даяр.

## Тазалоо жана тейлөө

1 Шаймандын розеткага сайылбаганын текшерипиз.

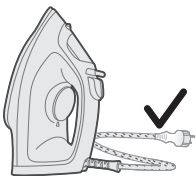
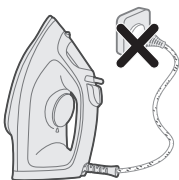

2 Шаймандын муздаганын текшерипиз.

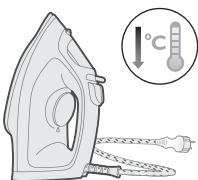

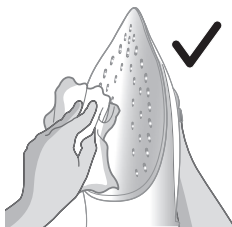

3 Үтүктүн астындагы үлпүлдөктөрдү жана башка калдыктарды нымдуу чүпүрөк менен сүртүңүз.



Эскертүү: Үтүктүн таманы дайыма жылмакай болуусу үчүн, ал металлдан жасалган нерселерге катуу урулуусуна жол бербейиз. Үтүктүн таманын тазалоо үчүн эч качан жышкычты, уксусту же башка химикаттарды колдонбоңуз.

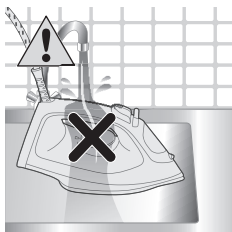

4 Шайманды агын суунун астында жуубаңыз/ тазалабаңыз.

## Кебээр тазалоо

Кеңеш: "Бат кебээр тазалоо" функциясын каалаган убакта колдонсо болот. Эгерде сиз суунун катуулугу жогору аймакта жашасаңыз, бул функцияны тез-тезден колдонуңуз.



1 1 ай колдонгондон кийин, анын иштөө мөөнөтүн узартуу жана шаймандын ысышын камсыз кылуу максатында шайманыңызда чогулган кебээрдди алып салуу үчүн кебээрдди тазалоо ишин аткарып туруу сунушталат.

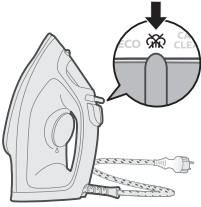

2 Үтүктү розеткадан ажыратылганын жана буусуз режимине коюлганын текшериңиз (кургак үтүктөө) .

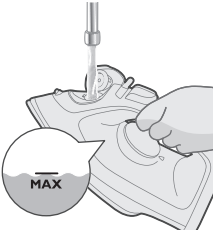

3 Суу челегин MAX белгисине чейин толтуруңуз.



4 Температура тергичин MAX абалына коюңуз.

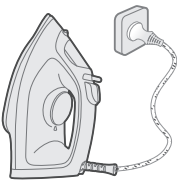

5 Шайманды жерге туташтырылган розеткага гана сайыңыз.

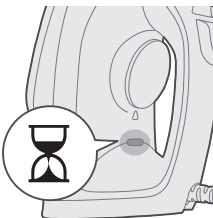

6 "Үтүк даяр" көрсөткүчү күйүп, шайман ысып жатканын көрсөтөт.

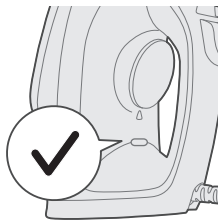

7 "Үтүк даяр" көрсөткүчүнүн өчүшүн күтүңүз.

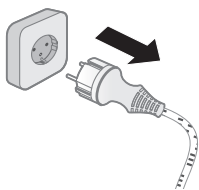

8 Үтүктү розеткадан сууруңуз.

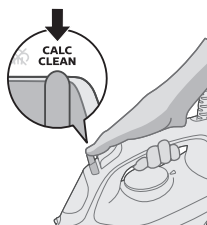

9 Буу режимин "Кебээр тазалоо" абалына жылдырыпп, кармап туруңуз.



10 Үтүктү раковинанын үстүнө кармап, үтүктү акырын чайкаңыз. Таманынан ысык суу жана кебээр агып чыгат.

Абайла: Кебээр агып чыгып жатканда үтүктүн таманынан буу менен кайнап жаткан суу дагы кошо чыгат.

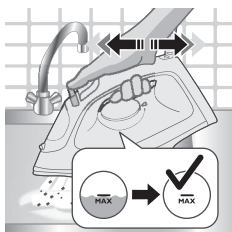

11 Суу челегиндеги суу бүткүчө үтүктү чайкай бериңиз.



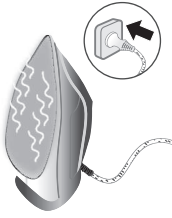

12 Шайманды розеткага сайып, таманын кургатуу үчүн үтүктү ысытыңыз. Бул болжол менен 2 мүнөт созулат.

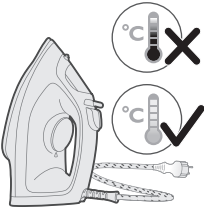

13 Үтүктү толук муздатыңыз.

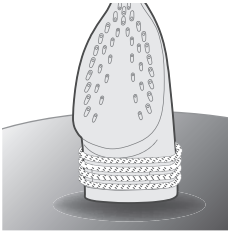

14 Шнурду үтүктүн согончогуна ороп коюңуз.

## Сактоо

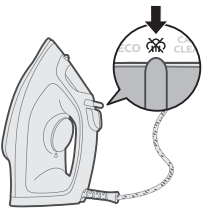

1 Буусуз режимди тандоо үчүн буу тандагычты жылдырыңыз (кургак үтүктөө) ~~ON~~.

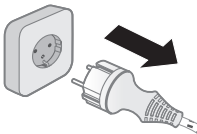

2 Шайманды розеткадан сууруңуз.

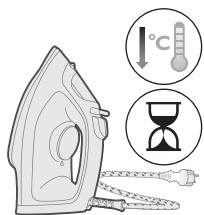

3 Шайманды толук муздатыңыз.

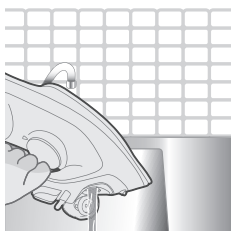

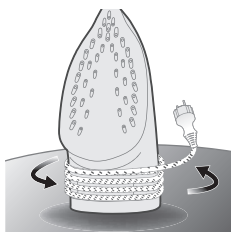

4 Суу челегинде калган сууну төгүп таштаңыз.



5 Электр шнурун шаймандын негизги корпусуна ороп коюңуз.

## Көйгөйлөрдү жоюу

Бул бөлүм сиз шайманды иштетүүдө кез келген жалпы көйгөйлөрдү камтыйт. Эгер маселени төмөндөгү маалымат менен чече албасаңыз, [www.philips.com/support](http://www.philips.com/support) баракчасынан көп берилүүчү суроолорду караңыз же өз өлкөңүздөгү Кардарларды тейлөө борборуна кайрылыңыз.

Көйгөй	Болжолдуу себеп	Көйгөйдү чечүү
Үтүк кийимдеги бырыштарды кетире албай жатат.	Үтүктөө учурунда буу жок.	Суу челегин толтуруп, буу сыдырмасын  абалына коюңуз.
Үтүктөн эч кандай буу чыкпай жатат.	Суу челегинде суу аз.	Суу челегин толтуруңуз.
	Буу сыдырмасы  абалына коюлган.	Буу сыдырмасын  абалына коюңуз.

	Үтүк буу чыгаруу үчүн жетишерлик түрдө ысык эмес.	Шайман ысып жатканда, “үтүк даяр” көрсөткүчү күйүп турат. Шайман колдонууга даяр болгондо, жарык өчөт.
Үтүктөө учурунда кийимге суу тамчылары тамып жатат.	Күчөтүү функциясын аз убакыттын ичинде өтө көп жолу колдонгонсуз.	Горизонталдуу абалда үтүктөөнү улантып, бууну күчөтүү функциясын кайра колдонуу үчүн бир аз күтө туруңуз.
	Суу челегинин капкагын туура жапкан эмессиз.	"Чык" эткен үн угулгуча капкакты басып туруңуз.
Үтүк бууну күчөтпөй жатат.	Бууну күчөтүү функциясын аз убакыттын ичинде өтө көп жолу колдонгонсуз.	Горизонталдуу абалда үтүктөөнү улантып, бууну күчөтүү функциясын кайра колдонуу үчүн бир аз күтө туруңуз.
	Үтүк үтүктөө үчүн жетишерлик түрдө ысык эмес.	"Үтүк даяр" көрсөткүчү күйүп-өчпөй, туруктуу күйүп калгыча күтө туруңуз.
	Суу челегине химиялык каражат куйгансыз.	Суу челегин чайкап, ага эч кандай атыр же химиялык каражаттарды куйбаңыз.
Үтүктү сууругандан кийин анын таманынан суу тамчылап жатат.	Буу сыдырмасы  абалына коюлган.	Буу сыдырмасын  абалына коюңуз.
	Сиз үтүктү суу челегиндеги суусу менен кошо горизонталдуу абалда коюп койгонсуз.	Колдонгондон кийин суу челегин бошотуңуз же үтүктү тик абалда сактаңыз.
Үтүк кийимге жалтырак же үтүктүн тагын калтырып жатат.	Үтүктөлө турган жер түз эмес болчу, мисалы, кийимдин тигишинин же бүктөлгөн жерлеринин үстүнөн үтүктөп жаткансыз.	Үтүктү бардык үтүктөөгө боло турган кийимдерге колдонуу коопсуз. Жалтырак же үтүктүн тагы биротоло калып калбайт, алар кийимди жууганда кетет. Кийимдин тигишинин же бүктөлгөн жерлеринин үстүнөн үтүктөбөңүз. Тактар калбоосу үчүн, үтүктөлө турган жерге кебез чүпүрөк коюп койсоңуз дагы болот.

# Вовед

Ви честитаме за купувањето и добре дојдовте во Philips! За да ја искористите целосната поддршка што ја нуди Philips, регистрирајте го вашиот производ на [www.philips.com/welcome](http://www.philips.com/welcome). Внимателно прочитајте го ова упатство за користење, брошурата со важни информации и водичот за брз почеток пред да го користите апаратот. Зачувајте ги за идни потреби.

## Преглед на производот

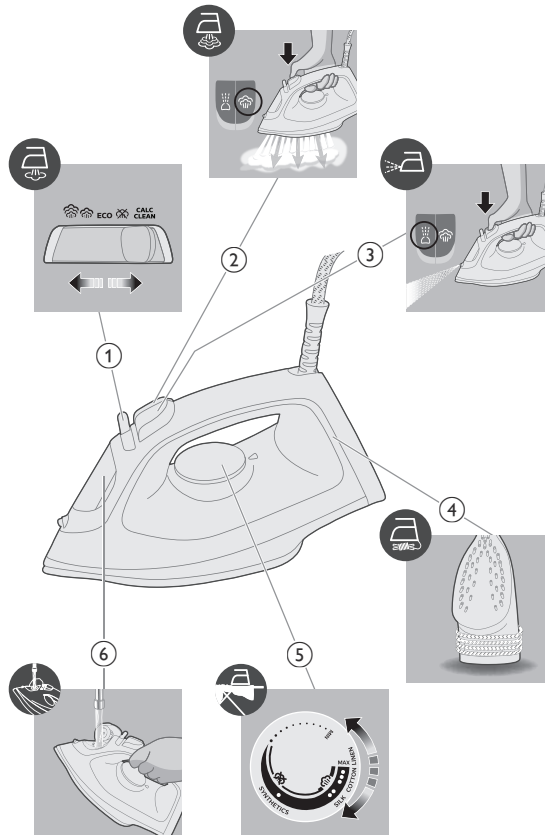

- 1 Копче за избор на пареа
- 2 Копче за дополнителна количина на пареа
- 3 Распрскување вода
- 4 Намотување на кабелот
- 5 Регулатор за температура
- 6 Капак на резервоарот за вода

## Користење на апаратот

### Подготовка за употреба

Забелешка: при првото користење, пеглата може да испушти малку пареа. Тоа ќе престане за кратко време.

#### Тип вода што треба да ја користите

Апаратот може да се користи со вода од чешма. Меѓутоа, ако живеете во подрачје со тврда вода, ви препорачуваме да измешате еднаква количина вода од чешма со дестилирана или деминерализирана вода. Ова ќе спречи брзо таложeње на бигор и ќе го продолжи работниот век на апаратот.

**Не додавајте парфимирана вода, вода од машина за сушење алишта, оцет, штирак, средства за отстранување бигор, адитиви за пеглање, вода што е хемиски исчистена од бигор или други хемикалии, затоа што можат да предизвикаат нагло исфрлување на вода, појава на кафени дамки или оштетување на апаратот.**

### Полнење на резервоарот за вода

- 1 Немојте да го приклучувате апаратот.

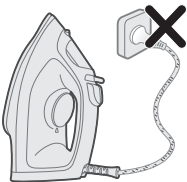

2 Проверете дали се оладил апаратот.

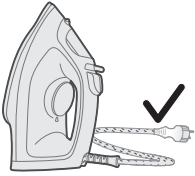

3 Поместете го копчето за избор на пареа надесно за да изберете режим без пареа (суво пеглање) ~~☒~~.

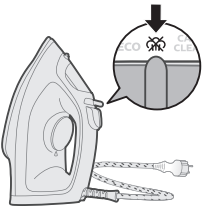

4 Отворете го капакот на резервоарот за вода.



5 Наполнете го резервоарот за вода до ознаката MAX во резервоарот.

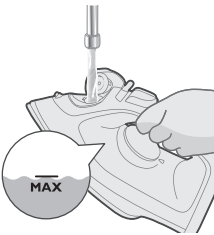

6 Цврсто затворете го капакот на резервоарот за вода.

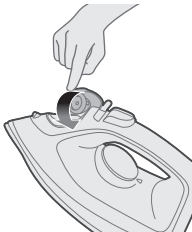

## Поставување температура



	MAX LINEN (ЛЕН)	
	● ● ● COTTON (ПАМУК)	
	● ● SILK (СВИЛА)	<b>ECO</b>
	● SYNTHETICS (СИНТЕТИКА)	



Поставка ECO: континуирано се испушта минимална константна количина на пара за облека со помалку набори. Оваа поставка заштедува и енергија.



Два облаци на пара: континуирано се испушта поголема константна количина на пара за отстранување на тврдокорните набори.



Три облаци на пара: континуирано се испушта максимална константна количина на пара за отстранување на тврдокорните набори.

## Користење на апаратот

- 1 Погледнете ја етикетата на облеката за потребното пеглање.



- 2 Поставете го регулаторот за температура на потребната температура за пеглање така што ќе го завртите на соодветната ознака за температура.

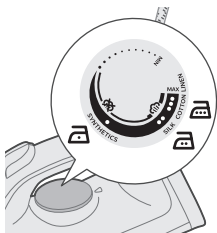

- 3 Поставете ја пеглата во исправена положба.

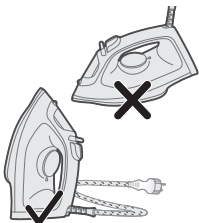

- 4 Приклучете го апаратот во заземјен сиден штекер.

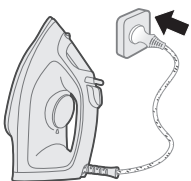

- 5 Индикаторот „пеглата е подготвена“ ќе почне да свети што значи дека пеглата се загрева.

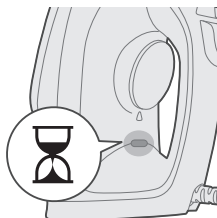



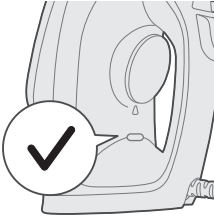

- 6 Кога ќе се исклучи индикаторот „пеглата е подготвена“, почекајте малку пред да започнете со пеглање. За време на пеглањето, индикаторот „пеглата е подготвена“ ќе се вклучува повремено.

## Без параа/Суво пеглање

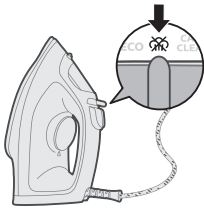

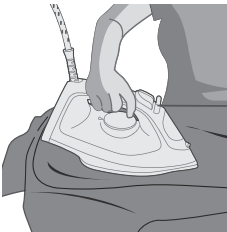

- 1 Изберете ја поставката без параа.

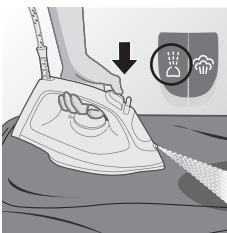

- 2 По кратко време, пареата ќе престане за време на пеглањето.

## Распрскување вода



- 1 Изберете ја поставката без параа. Притиснете и отпуштете го копчето за распрскување вода  за да ги отстраните тврдокорните набори.

## Дополнителна количина на пареа

- 1 Поставете го регулаторот за температура на поставката MAX помеѓу памук и лен.

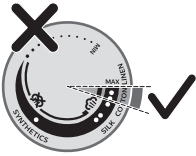

- 2 Притиснете и отпуштете го копчето за дополнителна количина на пареа за да генерирате мокна пареа што ќе ги отстрани тврдокорните набори.



- 3 Функцијата за дополнителна количина на пареа можете да ја користите кога ја држите пеглата во вертикална положба за отстранување набори на закачена облека (само за DST2020 и DST2030).

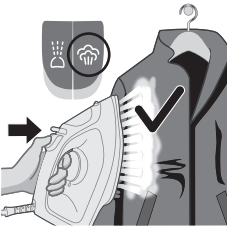

- 4 Повлечете и растегнете ја облеката додека применувате дополнителна количина на пареа за да ги отстраните тврдокорните набори (само за DST2020 и DST2030).

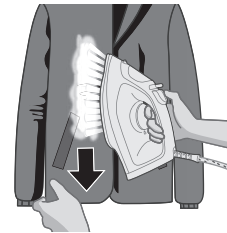

- 5 Немојте со гола дланка да ја потпирате облеката кога пеглате.



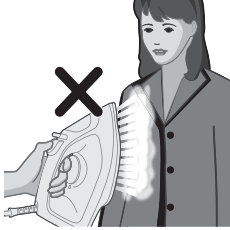

- 6 Немојте да го насочувате апаратот кон себе/друго лице.

## Автоматско исклучување (DST2030)

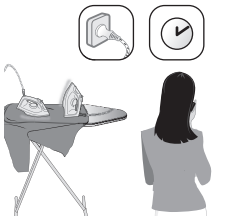

- 1 За да бидете безгрижни, апаратот самостојно ќе се олади ако го оставите без надзор одредено време.

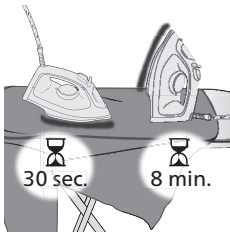

- 2 Ако апаратот не се користи повеќе од 30 секунди кога ќе се остави на грејната плоча или 8 минути кога ќе се остави во вертикална положба, апаратот ќе влезе во режимот на автоматско исклучување.

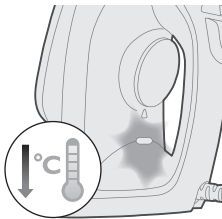

- 3 Температурата на апаратот ќе се намали во режимот на автоматско исклучување. Исто така, индикаторот „пеглата е подготвена“ ќе трепка постојано што значи дека апаратот се исклучил автоматски. За целосно исклучување на апаратот, исклучете го апаратот од штекер.

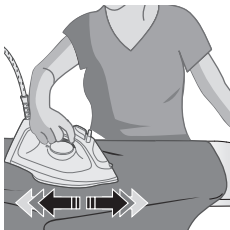

- 4 За повторно да се загрее апаратот, подигнете го или поместете го малку.

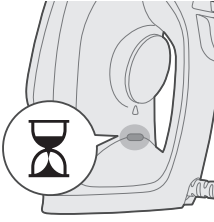

5 Индикаторот „пеглата е подготвена“ ќе почне да свети што значи дека пеглата се загрева.

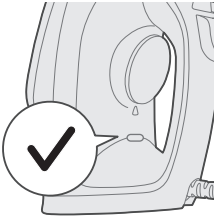

6 Кога ќе се исклучи индикаторот „пеглата е подготвена“, апаратот е подготвен за употреба.

## Чистење и одржување

1 Уверете се дека апаратот не е приклучен во штекер.

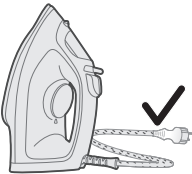
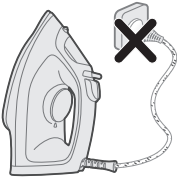

2 Проверете дали се оладил апаратот.

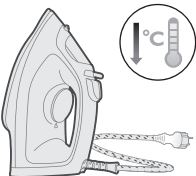

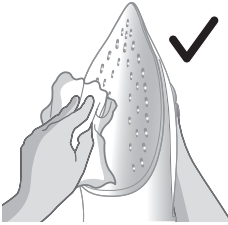

- 3 Исчистете ги парчињата бигор и другите нечистотии од грејната плоча со влажна крпа.

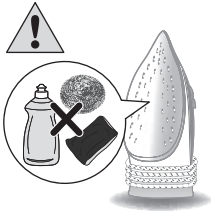

Забелешка: грејната плоча секогаш треба да биде мазна, па затоа избегнувајте контакт со метални предмети. Никогаш немојте да ја чистите грејната плоча со сунѓерчиња за триење, оцет или други хемикалии.

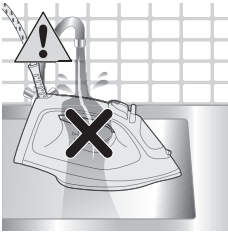

- 4 Немојте да го миете/чистите апаратот под млаз вода.

## Calc-Clean

Совет: функцијата Quick Calc Release може да се користи во секое време. Ако живеете во подрачје со тврда вода, користете ја функцијата почесто.



- 1 По 1 месец користење, ви препорачуваме да ја извршите функцијата Calc-Clean за да го отстраните бигорот наталожен во вашиот апарат за да се продолжи неговиот век на траење и да се овозможи загревање на апаратот.

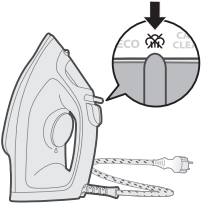

2 Уверете се дека пеглата не е приклучена во штекер и дека е избрана поставката без пара (суво пеглање) .

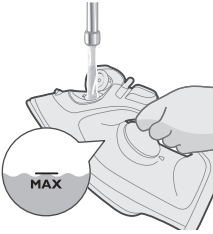

3 Наполнете го резервоарот за вода до ознаката MAX.



4 Поставете го регулаторот за температура на MAX.

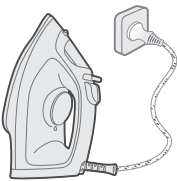

5 Приклучете го апаратот во заземјен сиден штекер.

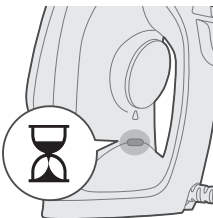

6 Индикаторот „пеглата е подготвена“ ќе почне да свети што значи дека пеглата се загрева.

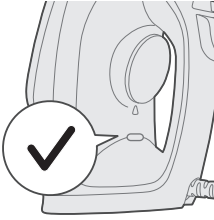

7 Почекајте да се исклучи индикаторот „пеглата е подготвена“.

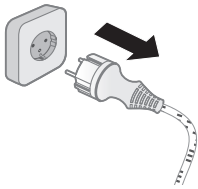

8 Исклучете ја пеглата од штекер.

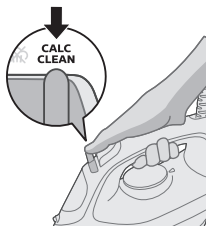

9 Повлечете го копчето за избор на пареа во положбата Calc-Clean и задржете го.



10 Држете ја пеглата над мијалникот и нежно тресете ја. Од грејната плоча ќе излезат честички на бигор и врела вода.

Внимание: при плакнењето на бигорот, од грејната плоча излегуваат пареа и врела вода.

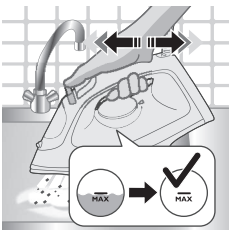

11 Продолжете да ја тресете пеглата сè додека не истече целата вода од резервоарот.



12 Приклучете го апаратот во штекер и оставете го да се загрее за да се исуши грејната плоча. Ова трае приближно 2 минути.

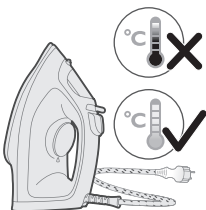

13 Почекајте да се олади пеглата.

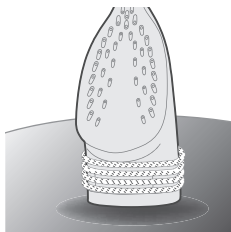

14 Намотајте го кабелот за напојување околу долниот дел на пеглата.

## Складирање

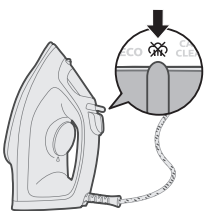

1 Поместете го копчето за избор на пареа за да изберете режим без пареа (суво пеглање) ~~ON~~.

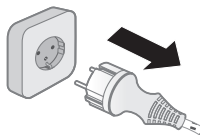

2 Исклучете го апаратот од штекер.



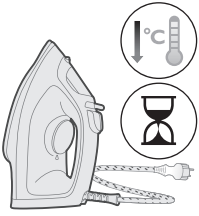

3 Почекајте да се олади апаратот.

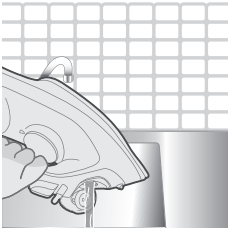

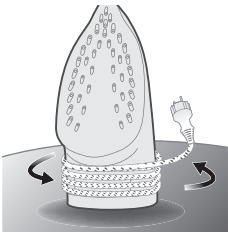

4 Истурете го остатокот вода од резервоарот за вода.



5 Намотајте го кабелот за напојување околу главното куќиште на апаратот.

## Решавање проблеми

Во ова поглавје се опишани најчестите проблеми со кои може да се соочите при користење на апаратот. Ако не можете да го решите проблемот со помош на информациите наведени подолу, посетете ја веб-страницата [www.philips.com/support](http://www.philips.com/support) за да најдете листа на најчести прашања или контактирајте со центарот за корисничка поддршка во вашата земја.

Проблем	Можна причина	Решение
Пеглата не може да ги отстрани наборите од облеката.	Нема пара во текот на пеглањето.	Наполнете го резервоарот за вода и поставете го лизгачкото копче за пара во положбата  .
Пеглата не создава пара.	Во резервоарот нема доволно вода.	Наполнете го резервоарот за вода.
	Лизгачкото копче за пара е поставено во положбата  .	Поставете го лизгачкото копче за пара во положбата  .

	Пеглата сè уште не е доволно загреана за да произведува пареа.	Додека пеглата се загрева, индикаторот „пеглата е подготвена“ свети постојано. Кога пеглата е подготвена за користење, индикаторот ќе се исклучи.
Во текот на пеглањето паѓаат капки вода на облеката.	Премногу често сте ја користеле функцијата за дополнителна количина на пареа во краток период.	Продолжете да пеглате во хоризонтална положба и почекајте малку пред повторно да ја користите функцијата за дополнителна количина на пареа.
	Не сте го затвориле добро капакот на резервоарот за вода.	Притискајте го капакот сè додека не слушнете „клик“.
Пеглата не создава дополнителна пареа.	Премногу често сте ја користеле функцијата за дополнителна количина на пареа во краток период.	Продолжете да пеглате во хоризонтална положба и почекајте малку пред повторно да ја користите функцијата за дополнителна количина на пареа.
	Пеглата сè уште не е доволно загреана за пеглање.	Почекајте индикаторот „пеглата е подготвена“ да престане да трепка и да почне постојано да свети.
	Сте ставиле хемикалија во резервоарот за вода.	Измијте го резервоарот за вода и немојте да ставате парфем ниту хемикалии во него.
Од грејната плоча капе вода откако ќе ја исклучите пеглата од штекер.	Лизгачкото копче за пареа е поставено во положбата  .	Поставете го лизгачкото копче за пареа во положбата  .
	Пеглата сте ја ставиле во хоризонтална положба со преостаната вода во резервоарот.	Испразнете го резервоарот за вода по употребата или складирајте ја пеглата во вертикална положба.
Пеглата остава сјајни дамки или отпечатоци на облеката.	Површината за пеглање била нерамна, на пример затоа што сте пеглале преку шевови или набори на облеката.	Пеглата може безбедно да се користи на секаква облека што може да се пегла. Сјајните дамки или отпечатоците не се трајни и ќе се отстранат со перење на облеката. Избегнувајте пеглање преку шевови или набори. Можете да ставите и памучна крпа врз површината за пеглање за да избегнете појава на отпечатоци.

## Введение

Поздравляем с покупкой и приветствуем в клубе Philips! Чтобы воспользоваться всеми преимуществами поддержки Philips, зарегистрируйте продукт на сайте [www.philips.com/welcome](http://www.philips.com/welcome). Перед использованием прибора внимательно ознакомьтесь с данной инструкцией по эксплуатации, важной информацией в буклете и с кратким руководством пользователя. Сохраните их для дальнейшего использования.

## Обзор изделия

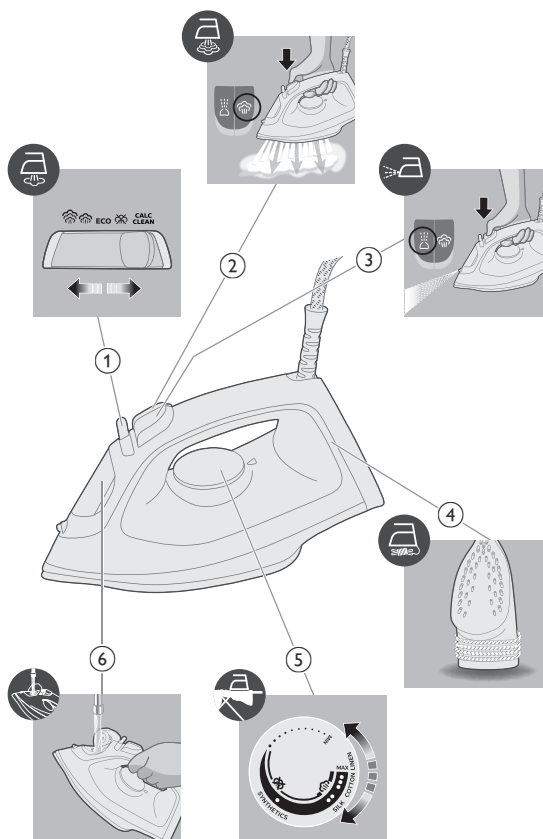

- 1 Переключатель пара
- 2 Кнопка парового удара
- 3 Спрей
- 4 Подмотка шнура
- 5 Дискový регулятор нагрева
- 6 Крышка резервуара для воды

## Использование прибора

### Подготовка к использованию прибора

Примечание. При первом использовании утюга может появляться небольшое количество дыма. Вскоре явление исчезнет.

#### Тип используемой воды

Прибор пригоден для использования с водопроводной водой. Однако если вы живете в регионе с жесткой водой, рекомендуется смешивать водопроводную воду с деминерализованной водой в равных пропорциях. Это поможет избежать быстрого образования накипи и продлит срок службы прибора.

**Во избежание появления протечек, коричневых пятен или повреждения прибора не используйте духи, воду из сушильной машины, уксус, крахмал, средства очистки от накипи, добавки для глажения, химические вещества и воду, подвергшуюся очистке от накипи с использованием химических средств.**

### Заполнение резервуара для воды

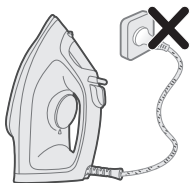

- 1 Не подключайте прибор к электросети.

2 Убедитесь, что прибор остыл.

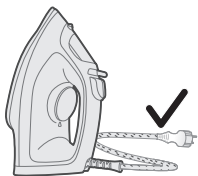

3 Сдвиньте переключатель пара вправо, чтобы выбрать режим без пара (сухое глажение) ~~☑~~.

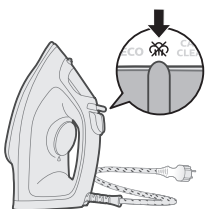

4 Откиньте крышку резервуара для воды.

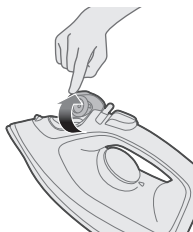

5 Заполните резервуар водопроводной водой до отметки MAX.

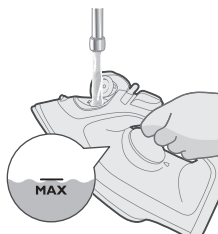

6 Плотно закройте крышку резервуара для воды.

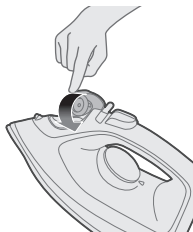

## Настройка температуры



	МАКС ЛЕН	
	● ● ● ХЛОПОК	
	● ● ШЕЛК	<b>ECO</b>
	● СИНТЕТИКА	

ECO



Режим ECO: Непрерывная подача минимального количества пара для обработки вещей с менее серьезными складками. В этом режиме прибор также экономит энергию.



Два облачка пара: Стабильная подача большего количества пара для более серьезных складок.



Три облачка пара: Стабильная подача максимального количества пара для самых серьезных складок.

## Использование прибора

1 См. этикетку на вещи для выбора рекомендуемого режима глажения.

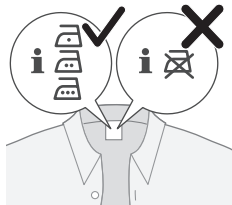

2 Выберите на регуляторе температуры желаемую температуру глажения, повернув его к нужному значению.

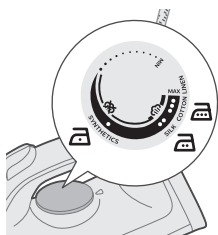

3 Оставьте утюг остывать в вертикальном положении.

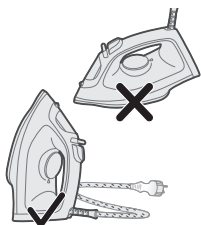

4 Подключите прибор к заземленной розетке.

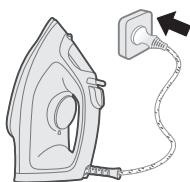

5 Загорится индикатор готовности утюга; прибор находится в состоянии нагрева.

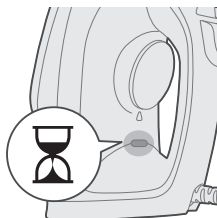

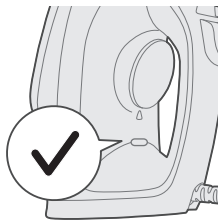

- 6 Когда индикатор готовности погаснет, немного подождите перед началом глажения. Индикатор готовности иногда будет загораться во время глажения.

## Без пара / сухое глажение

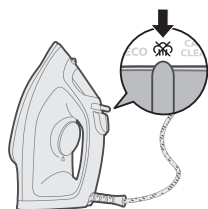

- 1 Выберите режим глажения без пара.

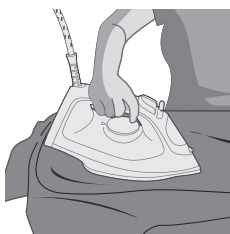

- 2 Через некоторое время пар перестанет подаваться при глажении.

## Спрей



- 1 Выберите режим глажения без пара. Нажмите и отпустите кнопку спрея ☼, чтобы подать облако водяного пара для разглаживания сложных складок.



## Паровой удар

- 1 Выберите температуру МАКС (между значениями "Хлопок" и "Лен").

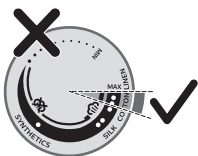

- 2 Нажмите и отпустите кнопку парового удара, чтобы подать большое количество пара для разглаживания сложных складок.



- 3 Вы можете задействовать функцию парового удара, удерживая утюг в вертикальном положении, для удаления складок на висящей одежде (только модели DST2020 и DST2030).

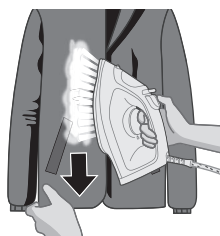

- 4 Растяните ткань во время использования парового удара, чтобы удалить сложные складки (только модели DST2020 и DST2030).



- 5 Не подкладывайте руку под ткань во время глажения.

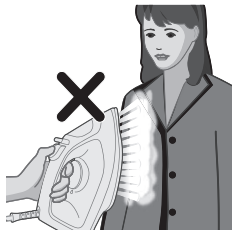

6 Не направляйте прибор на себя и других людей.

## Режим автоотключения (DST2030)



1 Для вашего спокойствия прибор автоматически начнет остывать, если оставить его без присмотра на определенный период времени.

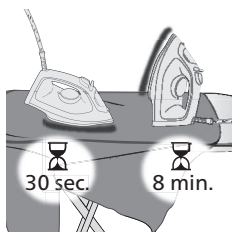

2 Если прибор не используется в течение более чем 30 секунд, находясь на подошве, или более 8 минут в вертикальном положении (на подставке/основании), он перейдет в режим автоматического выключения.

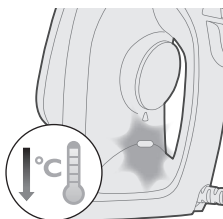

3 В режиме автоматического выключения температура прибора будет постепенно снижаться. Значок готовности также будет непрерывно мигать, указывая на состояние автоматического выключения. Чтобы полностью выключить прибор, извлеките его штекер из розетки электросети.

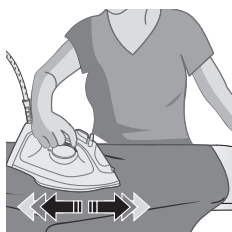

4 Для повторного нагрева прибора возьмите его в руку или немного пошевелите.

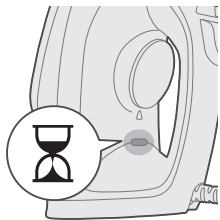

5 Загорится индикатор готовности утюга; прибор находится в состоянии нагрева.

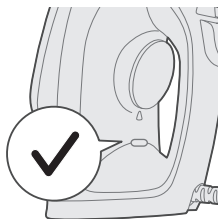

6 Когда индикатор готовности погаснет, это будет означать, что прибор готов к работе.

## Очистка и уход

1 Убедитесь, что прибор не подключен к электросети.

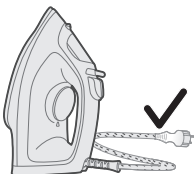
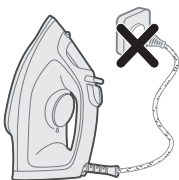

2 Убедитесь, что прибор остыл.

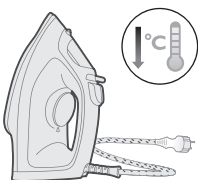

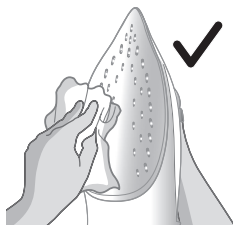

- 3 Вытрите влажной тканью хлопья накипи и другие предметы с подошвы.



Примечание. Для поддержания гладкой поверхности подошвы избегайте контакта жестких вещей с металлическими объектами. Не используйте металлическую губку, уксус и другие химикаты для очистки подошвы.

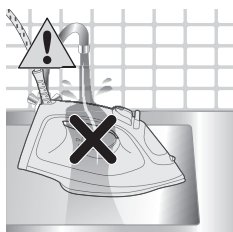

- 4 Запрещается промывать прибор проточной водой.

## Calc-Clean

Совет. Функция Quick Calc Release доступна для активации в любое время. Если вы живете в регионе с жесткой водой, используйте ее чаще.



- 1 После одного месяца использования прибора рекомендуется запустить очистку от накипи, чтобы удалить остатки накипи, скопившиеся в приборе, продлить его срок службы и обеспечить оптимальный нагрев.

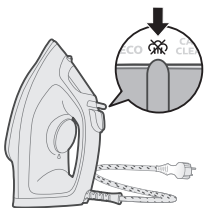

2 Убедитесь, что утюг отключен от электросети, а переключатель пара выставлен в положение без пара (сухое глажение) .

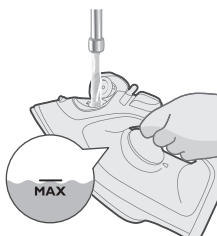

3 Заполните резервуар водопроводной водой до отметки MAX.

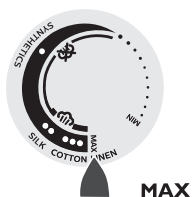

4 С помощью диска выберите температуру МАКС.

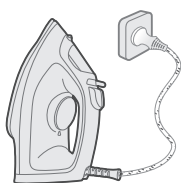

5 Подключите прибор к заземленной розетке.

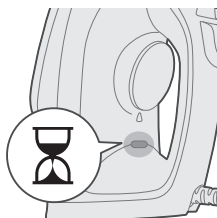

6 Загорится индикатор готовности утюга; прибор находится в состоянии нагрева.

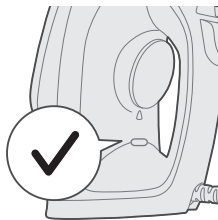

7 Подождите, пока этот индикатор не погаснет.

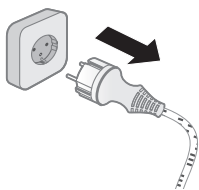

8 Отключите утюг от электросети.

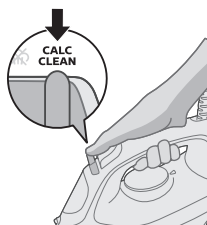

9 Сдвиньте ползунок пара в положение Calc-Clean и удерживайте его в этом положении.



10 Удерживая утюг на раковине, аккуратно встряхните его. Через подошву начнет подаваться горячая вода с частицами накипи.

Внимание! При вымывании накипи через подошву будет подаваться горячий пар и кипяток.

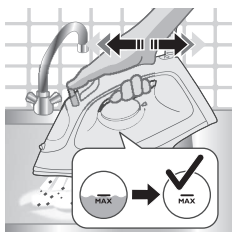

11 Продолжайте встряхивать утюг, пока резервуар для воды не опустеет.



**12** Подключите прибор к электросети и дайте ему нагреться, чтобы подошва утюга высохла. Подключение занимает примерно 2 минуты.

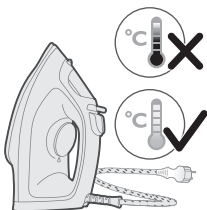

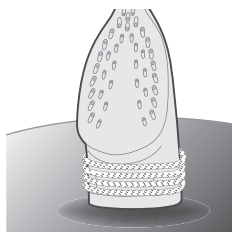

**13** Дайте утюгу остыть.

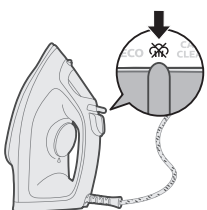

**14** Обмотайте сетевой шнур вокруг задней части прибора.

## Хранение



**1** Переведите переключатель пара в режим без пара (сухое глажение) .

**2** Отключите прибор от электросети.

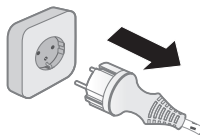

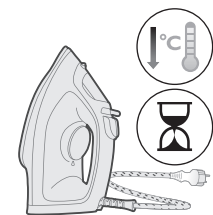

3 Дайте прибору остыть.

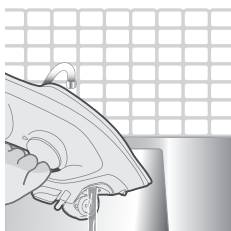

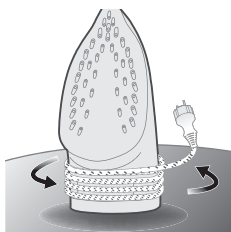

4 Вылейте остатки воды из резервуара.



5 Обмотайте сетевой шнур вокруг основной части прибора.

## Устранение неисправностей

В данной главе приведены проблемы, которые наиболее часто возникают при эксплуатации прибора. Если самостоятельно справиться с возникшими проблемами не удастся, см. список часто задаваемых вопросов на веб-странице [www.philips.com/support](http://www.philips.com/support) или обратитесь в центр поддержки потребителей в вашей стране.

Проблема	Возможная причина	Решение
Не удастся удалить складки с ткани утюгом.	Во время глажения не подается пар.	Наполните резервуар для воды и установите переключатель режимов подачи пара в положение  .
Утюг не вырабатывает пар.	В резервуаре недостаточно воды.	Заполните резервуар для воды.
	Переключатель режимов подачи пара установлен в положение  .	Установите переключатель режимов подачи пара в положение  .



	Утюг недостаточно нагрелся для подачи пара.	Во время нагрева утюга будет гореть индикатор готовности. Утюг готов к использованию, если индикатор перестал гореть.
Во время глажения на одежде появляются капли воды.	Вы использовали функцию парового удара слишком часто в течение короткого периода времени.	Продолжайте гладить в горизонтальном положении и немного подождите, прежде чем повторно использовать функцию парового удара.
	Крышка резервуара для воды не закрыта должным образом.	Нажимайте на крышку, пока не услышите щелчок.
Не срабатывает паровой удар.	Вы использовали функцию парового удара слишком часто в течение короткого периода времени.	Продолжайте гладить в горизонтальном положении и немного подождите, прежде чем повторно использовать функцию парового удара.
	Утюг недостаточно нагрелся.	Подождите, пока индикатор готовности перестанет мигать и загорится ровным светом.
	В резервуар для воды залито химическое соединение.	Промойте резервуар для воды и не добавляйте в него душистую воду или другие вещества.
После отключения утюга от сети из подошвы вытекает вода.	Переключатель режимов подачи пара установлен в положение  .	Установите переключатель режимов подачи пара в положение  .
	Утюг был оставлен в горизонтальном положении, в то время как в резервуаре все еще оставалась вода.	Опустошайте резервуар для воды после использования или храните утюг в вертикальном положении.
После использования утюга на ткани остается блеск или след от глажения.	Разглаживаемая поверхность была неровной, например, глажение выполнялось поверх шва или складки на одежде.	Утюг можно использовать для глажения любых тканей, допускающих глажение. Блеск или след исчезнет после стирки. Не выполняйте глажение поверх шва или складки на одежде. Чтобы избежать появления следов на одежде, можно поместить хлопчатобумажную ткань на разглаживаемую поверхность.

## Муқаддима

Шуморо барои харид табрик меғӯем ва ба Philips хуш омадед! Барои пурра истифода бурдан аз дастгириёе, ки Philips пешниҳод мекунад, маҳсулоти худро дар он сабти ном кунед [www.philips.com/welcome](http://www.philips.com/welcome). Пеш аз истифода бурдани дастгоҳ ин дастури қорбар, варақаи иттилооти муҳим ва дастури оғози зудро бодикқат хонед. Онҳоро барои истинод дар оянда захира кунед.

## Шарҳи маҳсулот

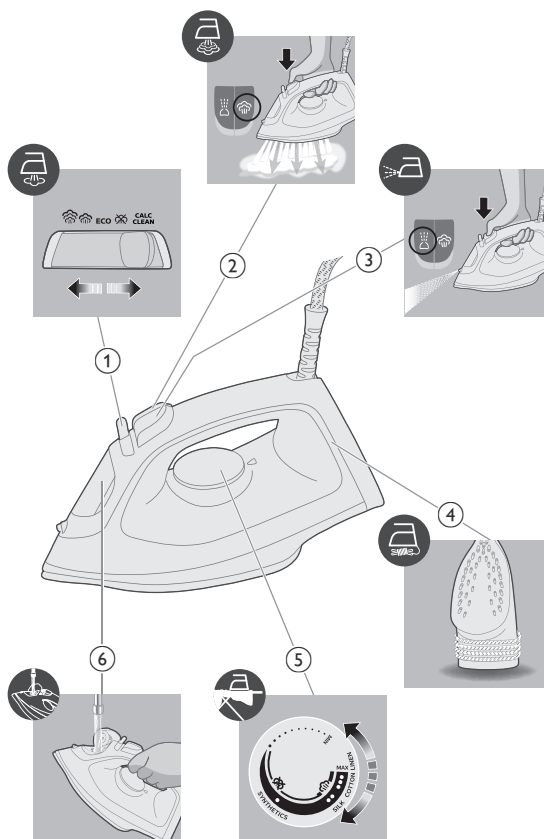

- 1 Интихобкунандаи буғ
- 2 Тугмаи тақвияти буғ
- 3 Пошидани об
- 4 Ҷойгоҳи сим
- 5 Ҷадвали ҳарорат
- 6 Сарпӯши зарфи об

## Истифодаи дастгоҳ

### Омодагӣ ба истифода

Шарҳ: Ҳангоми бори аввал истифода бурдан дарзмол метавонад каме дуд барорад. Ин пас аз муддати кӯтоҳ қатъ мешавад.

#### Навъи об барои истифода

Дастгоҳ барои истифода бо оби лӯла мувофиқ аст. Аммо, агар шумо дар як минтақаи оби сахт зиндагӣ кунед, мо ба шумо тавсия медиҳем, ки миқдори баробари оби лӯларо бо оби софшуда ё деминерализатсияшуда омехта кунед. Ин имкон медиҳад, ки зуд ҷамъшавии оҳаксанг пешгирӣ карда шавад ва мӯҳлати хизмати дастгоҳ дароз карда шавад.

**Оби хушбӯй, об аз мошини хушккунак, сирко, крахмал, маводҳо барои тозакунии аз карахш, асбобҳои дарзмолкунӣ, оби кимиёвӣ ва дигар моддаҳои кимиёвиро истифода набаред, зеро ин метавонад боиси рехтани об, доғи қаҳваранг ё вайрон шудани дастгоҳи шумо гардад.**

### Пур кардани зарфи об

- 1 Дастгоҳро дар васлаки барқӣ нагузоред.

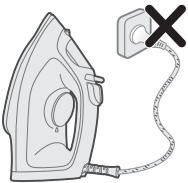

2 Боварӣ ҳосил кунед, ки дастгоҳ хунук шудааст.

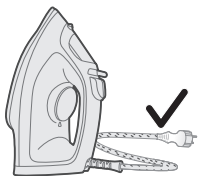

3 Интиҳобкунандаи буғро ба тарафи рост лағжонед, то режими буғро интиҳоб хомуш кунед (дарзмолкунии хушк) ~~ON~~.

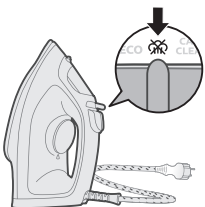

4 Сарпӯши зарфи обро кушоед.

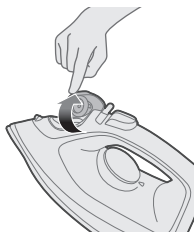

5 Зарфи обро то нишондиҳандаи МАКС пур кунед.

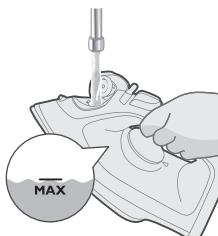

6 Сарпӯши зарфи обро саҳт пӯшед.

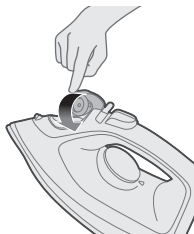

## Танизим кардани ҳарорат



	МАКС КАТОН	
	● ● ● ПАХТА	
	● ● АБРЕШИМ	<b>ECO</b>
	● СИНТЕТИКА	

ECO



Танзимои ECO: Буғи ҳадди ақали доимӣ барои либосҳое, ки қатҳои камтар доранд, пайваста дода мешавад. Ин танзим инчунин энергияро сарфа мекунад.



Ду абри буғӣ: Буғи бештари доимӣ пайваста барои қатҳои яқрав расонида мешавад.



Се абри буғӣ: Буғи максималии доимӣ пайваста барои қатҳои яқрав расонида мешавад.

## Истифодаи дастгоҳ

- 1 Тамғаи либосро барои дарзмолкунии зарурӣ тафтиш кунед.

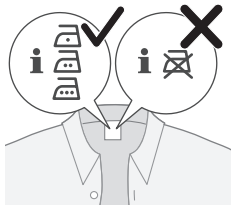

- 2 Чадвали ҳароратро ба ҳарорати зарурии дарзмолкунӣ гузошта, онро ба нишондиҳандаи мувофиқи ҳарорат табдил диҳед.

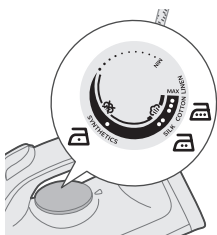

- 3 Бигзоред, ки дарзмол дар пошнаш истад.

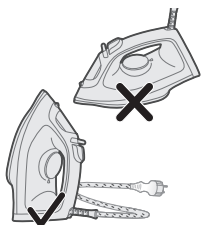

- 4 Сими дарзмолро ба васлаки деворӣ васл кунед.

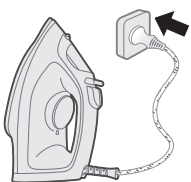

- 5 Нишондиҳандаи омодагии буғ фурузон мешавад, ки аз он шаҳодат медиҳад, ки дарзмол гарм шуда истодааст.

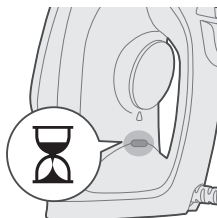

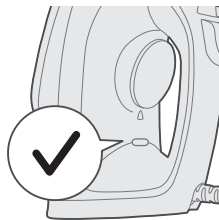

- 6 Вақте ки нишондиҳандаи дарзмол хомӯш шуд, пеш аз оғози дарзмол кардан каме интизор шавед. Ҳангоми дарзмолкунӣ нишондиҳандаи омодагии буғ гоҳ-гоҳ фурузон мешавад.

## Буғ нест/Дарзмолкунӣ хушк

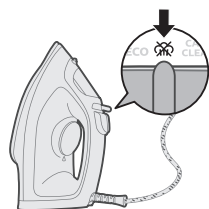

- 1 Танзимоти буғро ба танзимоти бе буғ муқаррар кунед.

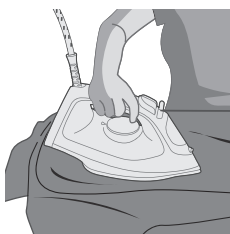

- 2 Пас аз як муддати кӯтоҳ буғ ҳангоми дарзмолкунӣ қатъ мегардад.

## Пошидани об



- 1 Танзимоти буғро ба танзимоти бе буғ муқаррар кунед. Тугмаи пошидани обро  барои ҷараёни туман пахш кунед ва раҳо кунед, то қатҳои мустаҳкамро ҳамвор кунед.

## Тақвияти буғ

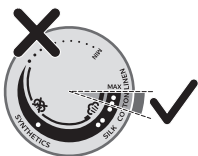

- 1 Ҷадвали ҳароратро ба танзимоти МАКС байни пахта ва катон таъин кунед.



- 2 Барои бартараф намудани қатъҳои калон тугмаи тақвияти буғро пахш кунед ва сар диҳед.



- 3 Шумо метавонед функсияи тақвияти буғро ҳангоми ба таври амудӣ нигоҳ доштани дарзмол барои дарзмол кардани либосҳои овезон истифода кунед (танҳо барои DST2020 ва DST2030).

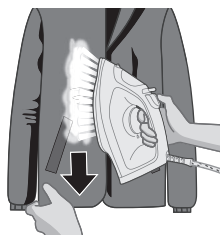

- 4 Ҳангоми истифода бурдани тақвияти буғ барои ҳамвор кардани қатҳои мустаҳкам либоси худро кашед ва дароз кунед (танҳо барои DST2020 ва DST2030).



- 5 Ҳангоми дарзмол кардан дасти лучро ҳамчун сатҳ истифода набаред.



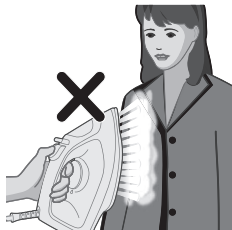

6 Дастгоҳро ба худ ё шахси дигар равона накунед.

## Ҳолати хомӯшкунии худкор (DST2030)

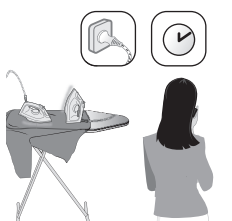

1 Барои оромии шумо, агар муддати тӯлонӣ беҳаракат нигоҳ дошта шавад, дастгоҳ ба таври худкор хунук мешавад.

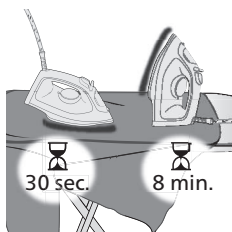

2 Вақте ки дастгоҳ дар тӯли зиёда аз 30 сония дар рӯи пояи худ ё 8 дақиқа дар пошна/пояш нигоҳ дошта шавад, дастгоҳ ба ҳолати хомӯшкунии худкор ворид мешавад.

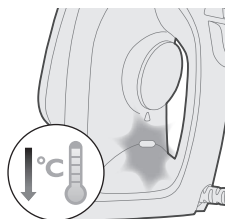

3 Ҳарорати дастгоҳ дар ҳолати хомӯшкунии худкор паст мешавад. Нишондиҳандаи "омодагии дарзмол" чашмак мезанад, то нишон диҳад, ки дастгоҳ дар ҳолати хомӯшкунии худкор ворид шудааст. Барои пурра хомӯш кардани дастгоҳ, дастгоҳро аз васлаки барқ ҷудо кунед.

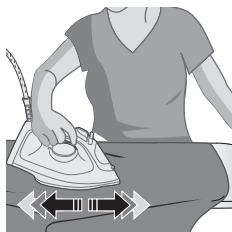

4 Барои дубора гарм шудани дастгоҳ, дастгоҳро гиред ё каме ҳаракат диҳед.

## 554 Тоҷикӣ

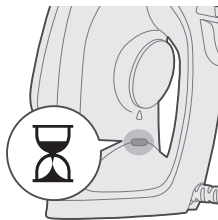

5 Нишондиҳандаи омодагии дарзмол фурузон мешавад, ки аз он шаҳодат медиҳад, ки дастгоҳ гарм шуда истодааст.

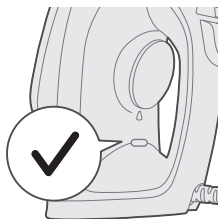

6 Вақте ки нишондиҳандаи омодагии дарзмол хомӯш мешавад, дастгоҳ барои истифода омода аст.

## Тозакунӣ ва нигоҳдори

1 Боварӣ ҳосил кунед, ки дастгоҳ ба васлаки барқӣ пайваст нашудааст.

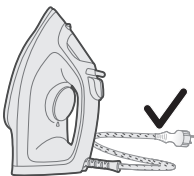
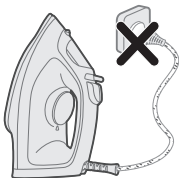

2 Боварӣ ҳосил кунед, ки дастгоҳ хунук шудааст.

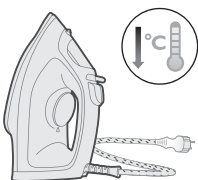

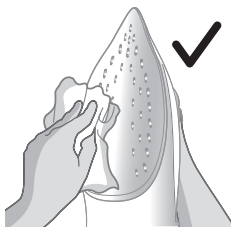

- 3 Карахш ва дигар боқимондаҳоро аз зери пояро бо матои намӣ ва тоза кунед.



Шарҳ: Барои ҳамвор нигоҳ доштани сатҳи поёни тахта, нагузored, ки он бо ашёҳои металлӣ тамос гирад. Барои тоза кардани зери поя исфанҷҳои абразивӣ, сирко ва дигар маводи кимиёвиро истифода набаред.



- 4 Дастгоҳро дар зери оби равон шустан/тоза кардан мумкин нест.

## Calc-Clean

Маслиҳат: Функцияи Quick Release Calc-ро дар ҳар вақт истифода бурдан мумкин аст. Агар шумо дар як минтақаи бо оби саҳт зиндагӣ кунед, ин функцияро зуд-зуд истифода баред.



- 1 Пас аз 1 моҳи истифода тавсия дода мешавад, ки карахшҳои дар дастгоҳи шумо ҷамъшударо бо функцияи Calc-Clean тоза кунед, то мӯҳлати истифодабарии дастгоҳро дароз кунед ва гармии дастгоҳро таъмин кунед.

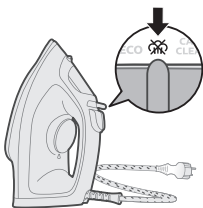

2 Боварӣ ҳосил кунед, ки дарзмол ҷудо карда шудааст ва танзими буғ ба ҳолати буғ гузошта нашудааст (дарзмолкунии хушк) .

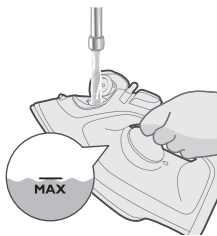

3 Зарфи обро то нишондиҳандаи МАКС пур кунед.

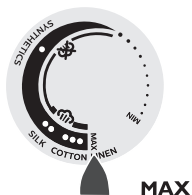

4 Ҷадвали ҳароратро ба МАКС таъин кунед.

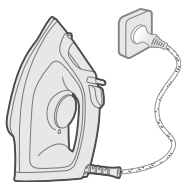

5 Таҷҳизотро танҳо ба васлаки девори заминӣ пайваст кунед.

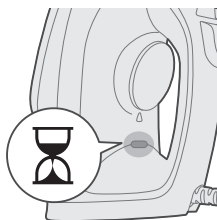

6 Нишондиҳандаи омодагии дарзмол фурузон мешавад, ки аз он шаҳодат медиҳад, ки дастгоҳ гарм шуда истодааст.

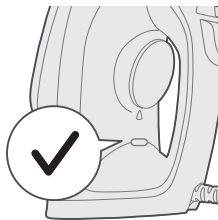

7 Интизор шавед, ки нишондиҳандаи омодагии дарзмол хомӯш шавад.

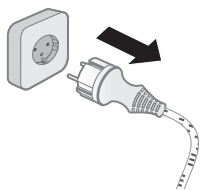

8 Дарзмолро аз васлак ҷудо кунед.

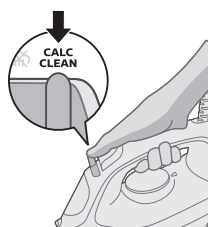

9 Интиҳобкунандаи буғро ба мавқеи Calc-Clean лағжонед ва онро нигоҳ доред.



10 Дарзмолро дар болои дастшуйак нигоҳ доред ва дарзмолро оҳишта чунбонед. Оби гарм ва зарраҳои карахш аз поя хориҷ мешаванд.

Огоҳӣ: Ҳангоми тоза кардани карахш аз пояи зер, ҷамчунин буғ ва оби ҷӯшон берун меояд.

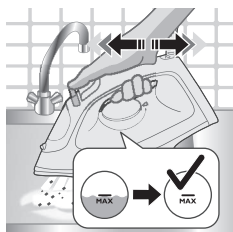

11 То он даме, ки тамоми оби зарфи об ҳоли нашавад, чунбониданро идома диҳед.

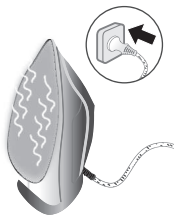

12 Дастгоҳро ба барқ пайваст кунед ва бигзоред, ки дастгоҳ гарм шавад, то пояи онро хушк кунед. Ин тақрибан 2 дақиқа мегирад.

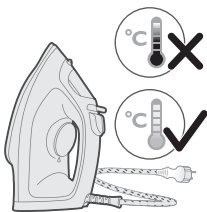

13 Бигзоред дарзмол хунук шавад.

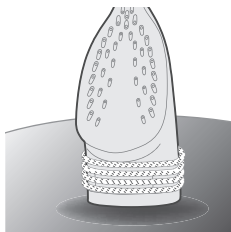

14 Симро дар атрофи пошнаи оҳан печонед.

## Захира

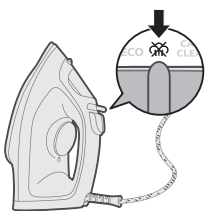

1 Интиҳобкунандаи буғро лағжонед, то ҳолати буғро хомуш кунед (дарзмолкунии хушк) ~~на~~.

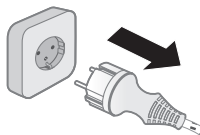

2 Дастгоҳро аз барқ ҷудо кунед.

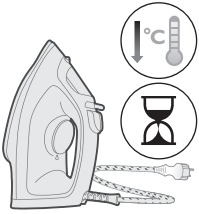

3 Бигзоред дастгоҳ пурра хунук шавад.

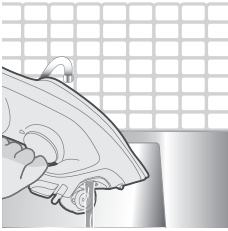

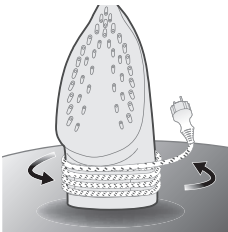

4 Оби боқимондари аз зарфи об резед.



5 Сими барқро дар атрофи корпуси асосии дастгоҳ тоб диҳед.

## Бартараф кардани мушкилот

Ин боб мушкилоти маъмултаринеро, ки шумо бо дастгоҳ дучор меоед, чамъбаст мекунад. Агар шумо наметавонед масъаларо бо маълумоти зерин ҳал кунед, ба [www.philips.com/support](http://www.philips.com/support) ташриф оваред, барои рӯйхати саволҳои зуд-зуд додешаванда ё бо Маркази Нигоҳубини Истеъмолкунандагон дар кишвари худ тамос гиред.

Мушкилот	Сабаби эҳтимолий	Роҳи ҳал
Дарзмол қатҳоро аз либос бартараф карда наметавонад.	Дар вақти дарзмолкунӣ буғ нест.	Зарфи обро пур кунед ва слайдери буғро ба  гузоред.
Дарзмол буғро намебарорад.	Дар зарф оби кам мавҷуд аст.	Зарфи обро пур кунед.
	Слайдери буғро ба мавқеи  гузаронед.	Слайдери буғро ба мавқеи  гузаронед.

	Дастгоҳ барои баровардани буғ ба таври кофӣ гарм нест.	Ҳангоми гарм шудани дастгоҳ, нишондиҳандаи "буғ омода аст" устувор гирон аст. Вақте ки дастгоҳ барои истифода омода аст, нишондиҳанда хомуш мегардад.
Ҳангоми дарзмол кардан ба болои либос қатраҳои об ҷорӣ мешаванд.	Шумо тақвияти буғро дар муддати кӯтоҳ мунтазам истифода кардед.	Дарзмол кардани уфуқро дар ҳолати уфуқӣ идома диҳед ва пеш аз дубора истифода бурдани функцияи тақвияти буғ каме интизор шавед.
	Шумо сарпӯши зарфи обро дуруст напӯшидед.	То он даме ки кликро нашунавед, сарпӯшро пахш кунед.
Дарзмол тақвияти буғро намебарорад.	Шумо тақвияти буғро дар муддати кӯтоҳ тез-тез истифода кардед.	Дарзмол кардани уфуқро дар ҳолати уфуқӣ идома диҳед ва пеш аз дубора истифода бурдани функцияи тақвияти буғ каме интизор шавед.
	Дарзмол ба таври кофӣ гарм нест.	Мунтазир бошед, ки нишондиҳандаи "омодагии дарзмол" ҳавокаширо қатъ кунад ва устувор фурузон шавад.
	Шумо дар зарфи об моеъи кимиёиро гузоштаед.	Зарфи обро бишӯед ва ба зарфи об ягон атриёт ё кимиёвӣ нагузоред.
Пас аз васлаки барқӣ ҷудо кардан аз пояи зер об ҷорӣ мешавад.	Слайдери буғро ба мавқеъи  гузаронед.	Слайдери буғро ба мавқеъи  гузаронед.
	Шумо оҳанро дар ҳолати уфуқӣ гузоштед ва об то ҳол дар зарфи об мондааст.	Пас аз истифода зарфи обро ҳолӣ кунед ё дарзмолро дар ҳолати амудӣ нигоҳ доред.
Дарзмол дар либос ҷило ё изи худро мегузорад.	Сатҳи дарзмол кардан нобаробар буд, масалан барои он ки шумо дар болои дарз ё пӯшиши либос дарзмол кардед.	Дарзмолро дар ҳама либосҳои дарзмолшаванда бехатар аст. Равшанӣ ё изи доимӣ нест ва ҳангоми шустани либос аз байн меравад. Аз дарзмол кардан дар болои дарзҳо ё қатҳо худдорӣ намоед. Шумо инчунин метавонед сатҳи худро бо матои пахта пӯшед, то нишона гузошта нашавад.



## Вступ

Вітаємо з придбанням виробу Philips! Щоб у повній мірі скористатися підтримкою, яку пропонує компанія Philips, зареєструйте свій виріб на вебсайті [www.philips.com/welcome](http://www.philips.com/welcome). Уважно прочитайте цей посібник користувача, інформаційний буклет і короткий посібник, перш ніж користуватися пристроєм. Зберігайте їх для майбутньої довідки.

## Огляд виробу

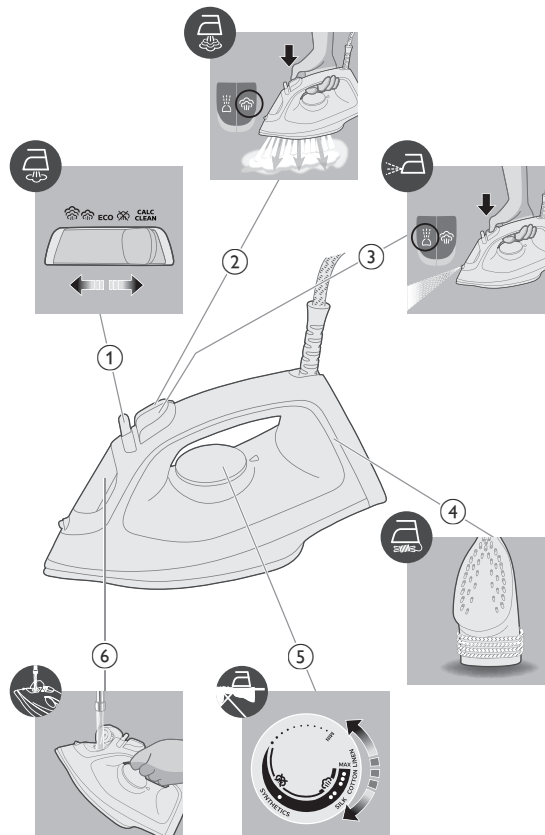

- 1 Регулятор пари
- 2 Кнопка парового удару
- 3 Розпилювач води
- 4 Область для намотування шнура
- 5 Регулятор температури
- 6 Кришка резервуара для води

## Використання пристрою

### Підготовка до використання

Примітка. Під час першого використання з праски може виходити пара. Це незабаром припиниться.

#### Тип води, яку слід використовувати

Для пристрою можна використовувати воду з-під крана. Однак якщо ви живете в області з жорсткою водою, ми рекомендуємо вам змішувати в рівних пропорціях воду з-під крана та дистильовану або демінералізовану воду. Це запобігатиме швидкому утворенню накипу та подовжить строк служби пристрою.

**Не додавайте парфуми, воду із сушильної машини, оцет, крохмаль, засоби проти накипу, засоби для прасування, воду після хімічного видалення накипу чи інші хімічні речовини, оскільки вони можуть спричинити розбризкування води, появу коричневих плям чи пошкодження пристрою.**

### Наповнення резервуара для води

- 1 Не під'єднуйте пристрій до мережі.

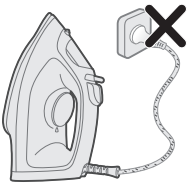

2 Перевірте, чи пристрій охолонув.

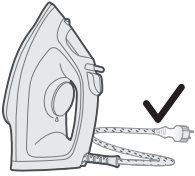

3 Пересуньте регулятор пари вправо для вибору режиму "без пари" (прасування без відпарювання) ~~☒~~.

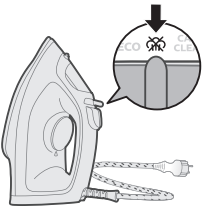

4 Відкрийте кришку резервуара для води.



5 Наповніть резервуар водою до позначки "MAX".

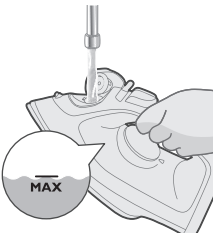

6 Щільно закрийте кришку резервуара для води.

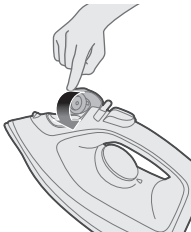

## Налаштування температури



	MAX LINEN	
	● ● ● COTTON	
	● ● SILK	<b>ECO</b>
	● SYNTHETICS	



Налаштування ECO: мінімальна постійна подача пари без перерви для прасування одягу з невеликою кількістю складок. Це налаштування також заощаджує енергію.



Дві парові хмари: більш постійна подача пари без перерви для прасування важких складок.



Три парові хмари: максимальна постійна подача пари без перерви для прасування надважких складок.

## Використання пристрою

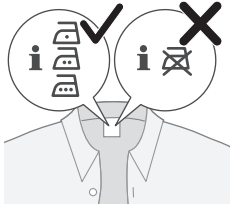

- 1 Перевірте значення допустимої температури прасування одягу на етикетці.

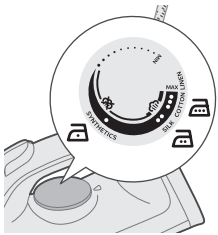

- 2 Виберіть регулятором температури потрібну температуру прасування, повернувши його у відповідне положення.

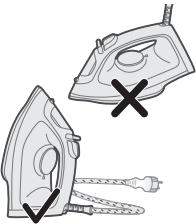

- 3 Поставте праску на п'яту.

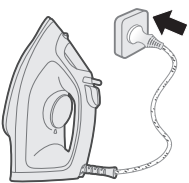

- 4 Під'єднайте пристрій до заземленої розетки.

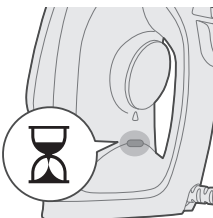

- 5 Засвітиться індикатор готовності праски, повідомляючи про її нагрівання.

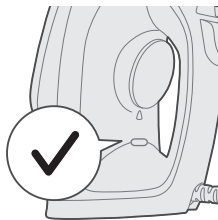

- 6 Коли згасне індикатор готовності праски, зачекайте трохи перед тим, як починати прасувати. Під час прасування індикатор готовності час від часу засвічуватиметься.

## Без пари/прасування без відпарювання

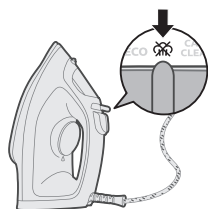

- 1 Виберіть налаштування "без пари".

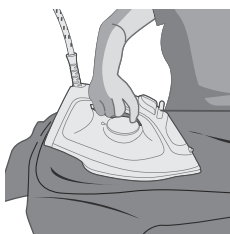

- 2 Незабаром пара перестане подаватися під час прасування.

## Розпилювач води



- 1 Виберіть налаштування "без пари". Натисніть та утримуйте кнопку розпилення води  для подачі дрібної пари й видалення складних складок.

## Паровий удар

- 1 За допомогою регулятора температури виберіть налаштування MAX між бавовною й льоном.

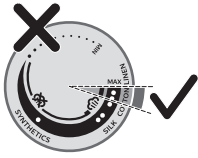

- 2 Натисніть і відпустіть кнопку парового удару, щоб отримати потужний паровий струмінь для прасування важких складок.

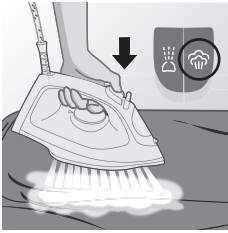

- 3 Функцію парового удару можна використовувати, тримаючи праску у вертикальному положенні під час прасування складок на підвішеному одязі (лише моделі DST2020 та DST2030).

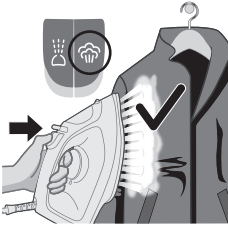

- 4 Щоб розпрасувати важкі складки, потягніть і розпрямте одяг, подаючи паровий удар (лише моделі DST2020 та DST2030).

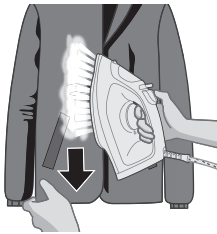

- 5 Не використовуйте голу руку як опорну поверхню під час прасування.



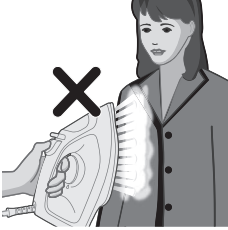

6 Не спрямовуйте пристрій на себе або інших людей.

## Автоматичне вимкнення (DST2030)



1 Щоб ви були спокійні, пристрій сам охолоне, якщо його залишити без нагляду на певний час.

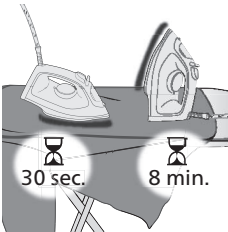
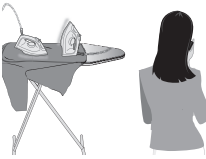

2 Якщо пристроєм не користуватися більше 30 секунд, коли він стоїть на підосві, або 8 хвилин, коли він на п'яті/підставці, то він перейде у режим автоматичного вимкнення.

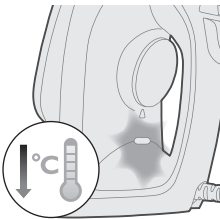

3 У режимі автоматичного вимкнення температура пристрою знизиться. Також безперервно буде блимати індикатор готовності праски, вказуючи на те, що пристрій перебуває в режимі автоматичного вимкнення. Щоб повністю вимкнути пристрій, від'єднайте його від розетки.

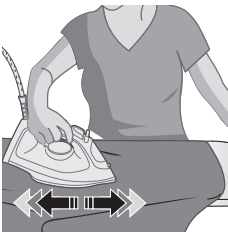

4 Щоб пристрій знову нагрівся, підніміть його або трохи ним порухайте.



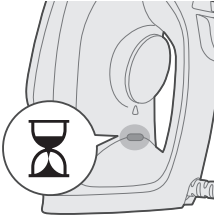

5 Засвітиться індикатор готовності праски, повідомляючи про нагрівання пристрою.

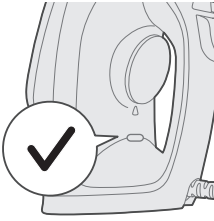

6 Щойно індикатор готовності праски вимкнеться, це означатиме, що пристрій готовий до роботи.

## Чищення та догляд

1 Переконайтеся, що пристрій не під'єднано до мережі.

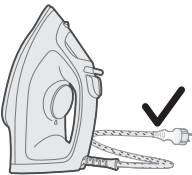
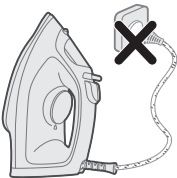

2 Перевірте, чи пристрій охолонув.

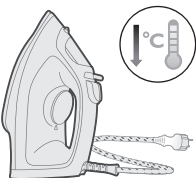



- 3 Витріть часточки та інші відкладення на підшві вологою ганчіркою.

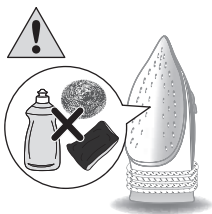

Примітка. Щоб підшва залишалася гладкою, уникайте жорсткого контакту з металевими предметами. Ніколи не використовуйте шліфувальні подушечки, оцет чи інші хімічні речовини для чищення підшви.

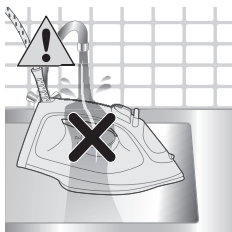

- 4 Не мийте пристрій проточною водою.

## Calc-Clean



Підказка. Функцію Quick Calc Release можна користуватися в будь-який час. Якщо у вашому регіоні жорстка вода, використовуйте функцію частіше.

- 1 Після 1 місяця використання рекомендовано виконати очищення від накипу, який накопився на пристрої, для продовження терміну служби пристрою й забезпечення його належного нагрівання.

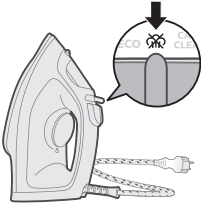

- 2 Праску має бути від'єднано від мережі, а регулятор пари має знаходитися у положенні "без пари" (прасування без відпарювання) .

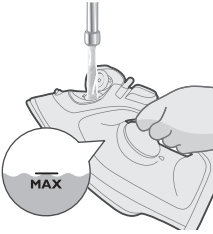

- 3 Наповніть резервуар для води до позначки MAX.



- 4 Встановіть регулятор температури у положення MAX.

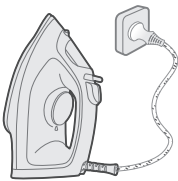

- 5 Підключіть пристрій до заземленої розетки.

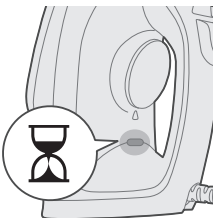

- 6 Засвітиться індикатор готовності праски, повідомляючи про нагрівання пристрою.

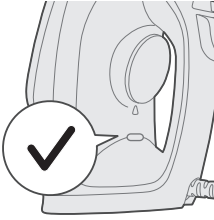

7 Зачекайте, поки індикатор готовності праски згасне.

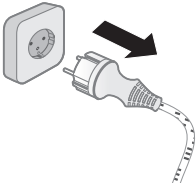

8 Від'єднайте праску від мережі.

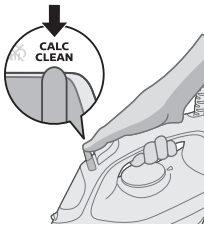

9 Пересуньте регулятор пари у положення видалення накипу Calc-Clean і зафіксуйте його.



10 Тримавши праску над раковиною, потрусіть нею. Із підшови буде виділятися гаряча вода й часточки накипу.

Увага! Під час видалення накипу з підшови також виходить пара та кипляча вода.

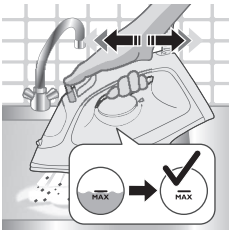

11 Продовжуйте струшувати праскою, поки з резервуара для води не вилітять вся вода.

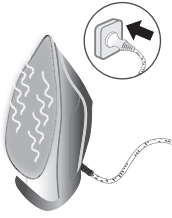

**12** Під'єднайте пристрій до мережі та дайте йому нагрітися, щоб висушити підощву. Це триватиме близько 2 хвилин.

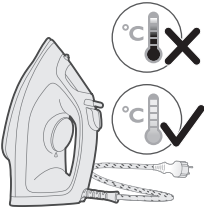

**13** Дайте прасці охолонути.

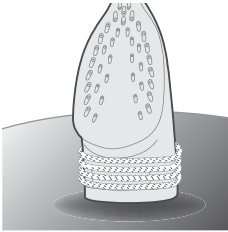

**14** Намотайте шнур на п'яту праски.

## Зберігання

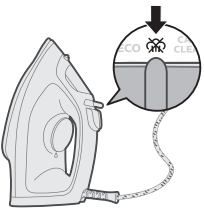

**1** Пересуньте регулятор пари для вибору режиму "без пари" (прасування без відпарювання) ~~OFF~~.

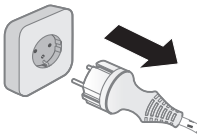

**2** Від'єднайте пристрій від мережі.

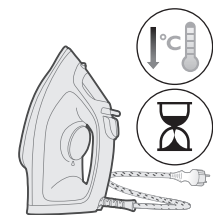

3 Дайте пристрою охолонути.

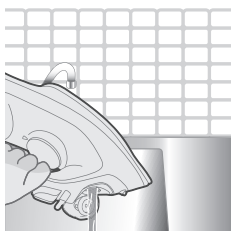

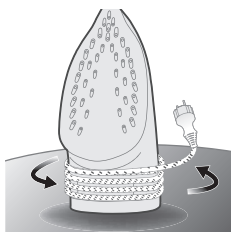

4 Вилийте залишки води з резервуара.



5 Намотайте кабель живлення на корпус пристрою.

## Усунення несправностей

У цьому розділі подано основні проблеми, які можуть виникнути під час використання пристрою. Якщо ви не в змозі вирішити проблему за допомогою інформації, поданої нижче, відвідайте вебсайт [www.philips.com/support](http://www.philips.com/support) для перегляду списку поширених запитань або зверніться до Центру обслуговування клієнтів у своїй країні.

Проблема	Можлива причина	Вирішення
Праска не прасує.	Під час прасування не виходить пара.	Наповніть резервуар водою і встановіть перемикач налаштування пари в положення  .
З праски не виходить пара.	У резервуарі недостатньо води.	Наповніть резервуар водою.
	Перемикач налаштування пари встановлено в положення  .	Встановіть перемикач налаштування пари в положення  .

	Праска ще недостатньо гаряча для створення пари.	Під час нагрівання індикатор готовності праски світиться постійно. Коли праска буде готова до використання, індикатор згасне.
Під час прасування краплі води крапають на тканину.	Ви використовували функцію парового удару надто часто протягом дуже короткого відрізка часу.	Продовжуйте прасувати у горизонтальному положенні та почекайте перед тим, як повторно використовувати функцію парового удару.
	Кришку резервуара для води не закрито належним чином.	Натисніть кришку до фіксації.
Праска не подає парового удару.	Ви використовували функцію парового удару надто часто протягом дуже короткого відрізка часу.	Продовжуйте прасувати у горизонтальному положенні та почекайте перед тим, як повторно використовувати функцію парового удару.
	Праска ще недостатньо гаряча для прасування.	Зчекайте, поки індикатор готовності праски не почне світитися без блимання.
	Ви наповнили резервуар для води хімічною речовиною.	Сполосніть резервуар для води та не наповнюйте його парфумами чи іншими хімічними речовинами.
Після від'єднання праски від мережі з підшови крапає вода.	Перемикач налаштування пари встановлено в положення  .	Встановіть перемикач налаштування пари в положення  .
	Праска перебувала в горизонтальному положенні, і в резервуарі залишалася вода.	Спорожніть резервуар для води після використання або зберігайте праску в вертикальному положенні.
Праска залишає блиск або відбитки на одязі.	Поверхня, яку потрібно прасувати, є нерівною, наприклад, через прасування поверх шва чи згину на одязі.	Праску безпечно використовувати на будь-якому одязі, який можна прасувати. Блиск або відбитки не залишаться назавжди, а зникнуть після прання одягу. Уникайте прасування по швах або складках. Щоб уникнути відбитків, можна також розмістити бавовняну тканину над ділянкою, яку потрібно випрасувати.

# Кіріспе

Осы затты сатып алуыңызбен құттықтаймыз және Philips компаниясына қош келдіңіз! Philips ұсынатын қолдауды толық пайдалану үшін өнімді [www.philips.com/welcome](http://www.philips.com/welcome) веб-сайтында тіркеңіз. Құрылғыны пайдаланбастан бұрын, осы пайдаланушы нұсқаулығын, маңызды ақпарат парақшасын және жылдам бастау нұсқаулығын мұқият оқып шығыңыз. Келешекте қарау үшін оларды сақтап қойыңыз.

## Өнімге шолу жасау

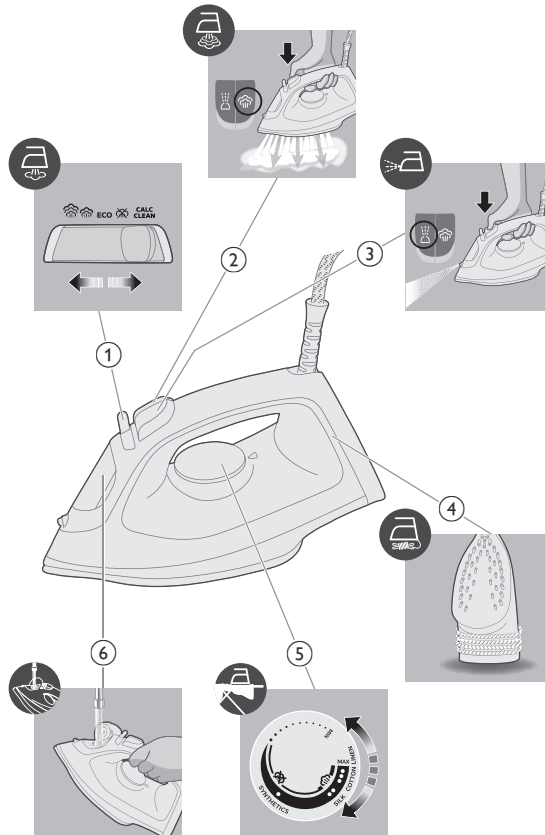



- 1 Бу таңдағыш
- 2 Бұды күшейту түймесі
- 3 Су шашқыш
- 4 Қуат сымын орау
- 5 Температураны реттеу дөңгелегі
- 6 Су багінің қақпағы

## Құрылғыны қолдану

### Пайдалануға дайындау

Ескертпе: Алғаш пайдаланған кезде, үтіктен шамалы бу шығуы мүмкін. Бұл аз уақыттан кейін тоқтайды.

#### Пайдаланылатын су түрі

Аспапты құбыр суымен бірге қолдануға болады. Алайда, егер сіздің ауданыңызда кермек су болса, біз құбыр суын тазартылған немесе минералсызданған сумен тең мөлшерде араластыруды ұсынамыз. Бұл қақтың тез жиналуының алдын алады және аспаптың қызмет ету мерзімін ұзартады.

**Иіссуды, кептіргіш барабаннан алынған суды, сірке суын, үтіктеуге көмектесетін сұйықтарды, химиялық жолмен қақ кетіретін суды немесе басқа химиялық заттарды қоспаңыз, себебі олар судың отыруына, қоңыр дақтардың қалуына себеп болуы немесе құрылғыны зақымдауы мүмкін.**

### Су ыдысын толтыру

- 1 Құрылғыны розеткаға қоспаңыз.

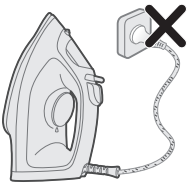

2 Құрылғыны суытып алыңыз.

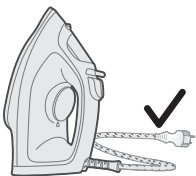

3 Бусыз режимді (құрғақ үтіктеу)  таңдау үшін бу таңдағышты оңға сырғытыңыз.

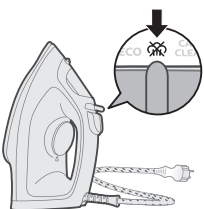

4 Су ыдысының қақпағын аударып ашыңыз.

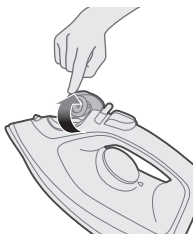

5 Су ыдысын MAX (Ең жоғ.) көрсеткішіне дейін сумен толтырыңыз.

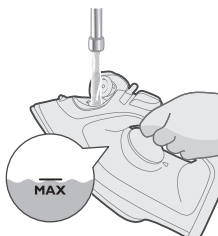

6 Су ыдысы қақпағын мықтап жабыңыз.

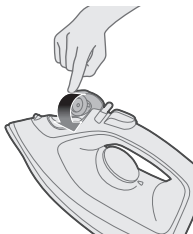

## Температураны орнату



	МАХ (Ең жоғ.) ЗЫҒЫР	
	● ● ● МАҚТА	
	● ● ЖІБЕК	<b>ECO</b>
	● СИНТЕТИКА	

ECO



ECO параметрі: аз қыртысты киімдерге ең аз тұрақты бу мөлшері жеткізіледі. Сонымен қатар, бұл параметр қуат үнемдейді.



Екі бу бұлты: қатты қыртыстарға ең көп тұрақты бу мөлшері жеткізіледі.



Үш бу бұлты: қатты қыртыстарға ең көп тұрақты бу мөлшері жеткізіледі.

## Құрылғыны қолдану

1 Киімнің этикеткасынан қалай үтіктеуге болатынын анықтап алыңыз.



2 Температура дөңгелегін үтіктеу температурасына сәйкес келетін көрсеткішке айналдыру арқылы орнатыңыз.

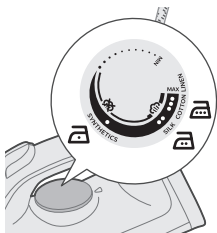

3 Үтікті табанының қырымен тұрғызыңыз.

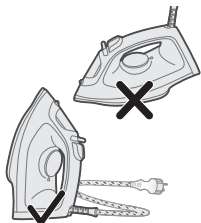

4 Құрылғыны жерге тұйықталған қабырға розеткасына қосыңыз.

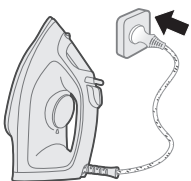

5 «Үтік дайын» шамы жанып, үтік қызып жатқанын көрсетеді.

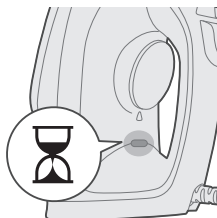

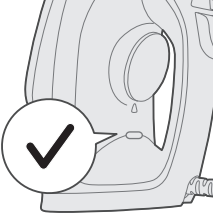

- 6 Үтіктеуді бастар алдында, «Үтік дайын» шамы сөнгеннен соң кішкене күте тұрыңыз. Үтіктеп жатқанда, «Үтік дайын» шамы анда-санда қайта жанып отырады.

## Бусыз/Құрғақ үтіктеу

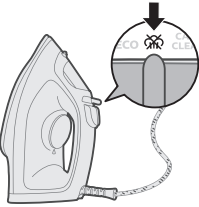

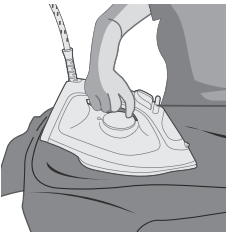

- 1 Бу параметрін бусыз параметріне орнатыңыз.

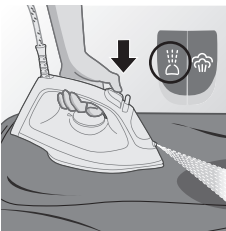

- 2 Біраз уақыттан кейін, үтіктеу кезінде бу тоқтайды.

## Су шашқыш



- 1 Бу параметрін бусыз параметріне орнатыңыз. Қатты қыртыстарды кетіру үшін тұман ағыны үшін су бүрку түймесін  басып, босатыңыз.

## Буды күшейту

- 1 Мақта мен зығыр мата арасындағы температура деңгелегін MAX (Ең жоғ.) параметріне қойыңыз.

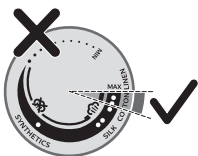

- 2 Қатты қыртыстарды кетіру үшін буды күшейтуге арналған буды күшейту түймесін басып, жібере салыңыз.



- 3 Ілулі тұрған киімдердегі қыртыстарды кетіру үшін үтіккі тігінен ұстап тұрып буды күшейту функциясын пайдалануға болады (DST2020 және DST2030 үлгілерінде).



- 4 Қатты қыртыстарды кетіру үшін буды күшейту функциясын қолданған кезде киімді тартып, созыңыз (DST2020 және DST2030 үлгілерінде).

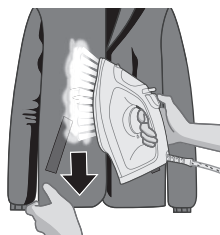

- 5 Үтіктеген кезде жалаңаш қолыңызбен ұстап тұрмаңыз.



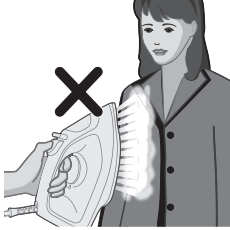

6 Құрылғыны өзіңізге/басқа адамға қаратпаңыз.

## Автоматты түрде сөну (DST2030)

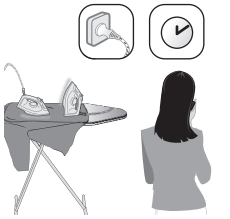

1 Сіз алаңдамау үшін құрылғы белгілі бір уақыт бойы қадағалаусыз қалса, өздігінен суиды.

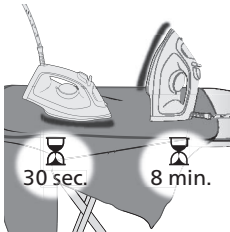

2 Құрылғы табанымен қойылғанда, 30 секундтан артық немесе қырында/табанында тұрып 8 минуттан артық пайдаланылмаса, құрылғы автоматты түрде өшіру режиміне өтеді.

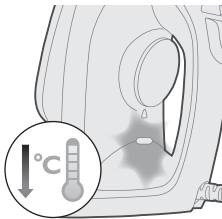

3 Автоматты өшіру режимінде құрылғының температурасы төмендейді. «Үтік дайын» шамы да құрылғы автоматты түрде өшіру күйіне өткенін көрсету үшін тоқтаусыз жыпылықтайды. Құрылғыны толығымен өшіру үшін құрылғыны розеткадан ажыратыңыз.

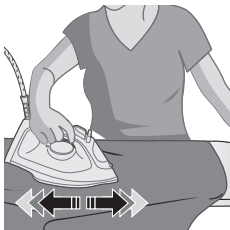

4 Құрылғыны қайтадан қыздыру үшін көтеріңіз немесе кішкене қозғаңыз.

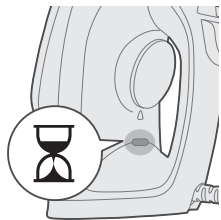

5 «Бу дайын» шамы жанып, құрылғының қызып жатқанын көрсетеді.

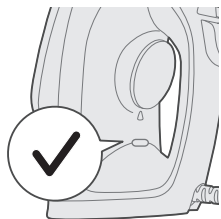

6 «Үтік дайын» шамы сөнгеннен кейін, құрылғыны пайдалануға болады.

## Тазалау және күту

1 Құрылғы розеткаға жалғанбағанын тексеріңіз.

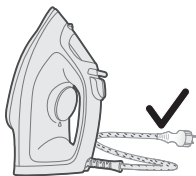
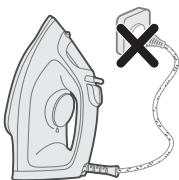

2 Құрылғының суын қамтамасыз етіңіз.

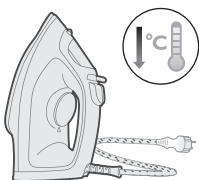





- 3 Үтіктің табанындағы үлпектерді және басқа қалдықтарды дымқыл шүберекпен сүртіп кетіріңіз.



Ескертпе: Үтіктің астыңғы табанын тегіс етіп сақтау үшін, оны металды заттарға қатты соғудан сақ болу керек. Үтіктің астыңғы табанын тазалау үшін қыратын шүберек, сірке суын немесе басқа химиялық заттарды қолдануға болмайды.



- 4 Құрылғыны ағынды сумен жумаңыз/тазаламаңыз.

## Calc-Clean



Кеңес: Жылдам қақтан босату функциясын кез келген уақытта пайдалануға болады. Егер суы кермек аймақта тұрсаңыз, функцияны жиі пайдаланыңыз.

- 1 1 ай қолданғаннан кейін, құрылғының ішінде жиналған қақтарды кетіру үшін қақты тазалаған жөн, бұл — құрылғының қызмет мерзімін ұзартады және құрылғының қызуын қамтамасыз етеді.

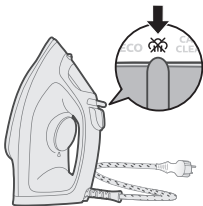

2 Құрылғы қуат көзінен ажыратылғанын және бу параметрі бусыз режимінде (бусыз үтіктеу)  тұрғанын тексеріңіз.

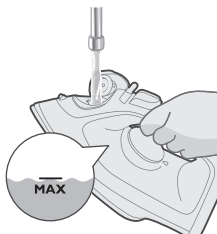

3 Су ыдысын MAX (Ең жоғ.) көрсеткішіне дейін толтырыңыз.

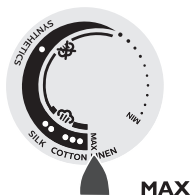

4 Температураны реттеу дөңгелегін ЕҢ ЖОҒ. мәніне қойыңыз.

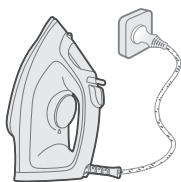

5 Құрылғыны жерге тұйықталған розеткаға қосыңыз.

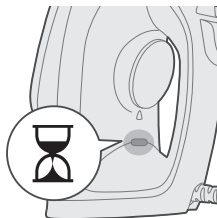

6 «Бу дайын» шамы жанып, құрылғының қызып жатқанын көрсетеді.

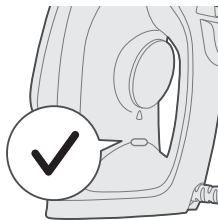

7 «Үтік дайын» шам сөнгенше күтіңіз.

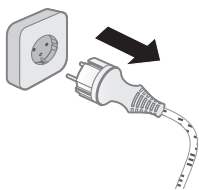

8 Үтікті розеткадан ажыратыңыз.

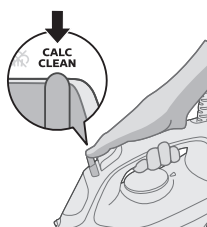

9 Бу таңдағышты Қақтан тазалау күйіне сырғытып, ұстап тұрыңыз.



10 Үтікті раковинаның үстінде ұстаңыз да, үтікті ақырын шайқаңыз. Үтік табанынан ыстық су мен қақ бөлшектері шығады.

Ескерту: Қақтар сумен шайылып кетеді, қайнаған су және бу үтіктің табанынан шыға бастайды.

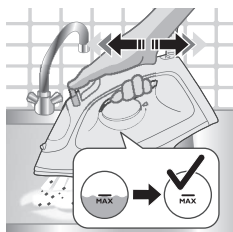

11 Су ыдысындағы су толығымен аққанша үтікті жаймен сілки беріңіз.

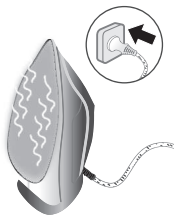

12 Құрылғыны розеткаға тығып, табан құрғауы үшін қыздырыңыз. Бұл шамамен 2 минут алады.

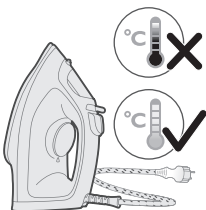

13 Үтікті суытып алыңыз.

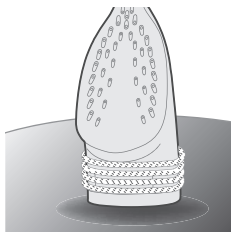

14 Сымын құрылғының аяғына ораңыз.

## Сақтау

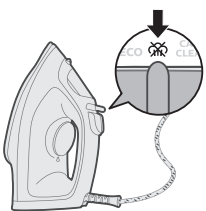

1 Бусыз режимді (құрғақ үтіктеу) ~~☒~~ таңдау үшін бу таңдағышын сырғытыңыз.

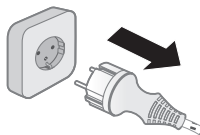

2 Құрылғыны ток көзінен ажыратыңыз.

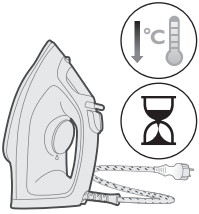

3 Құрылғыны суытып қойыңыз.

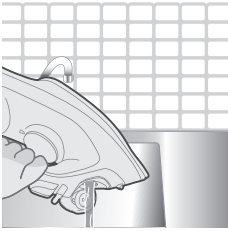

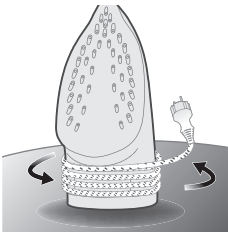

4 Су ыдысынан кез келген қалған суды төгіңіз.



5 Қуат сымын құрылғының корпусына ораңыз.

## Ақаулықтарды табу және жою

Бұл тарауда құралда орын алуы мүмкін ең көп кездесетін ақаулықтар жинақталған. Егер төмендегі ақпараттың көмегімен мәселені шеше алмасаңыз, [www.philips.com/support](http://www.philips.com/support) торабына кіріп, жиі қойылатын сұрақтар тізімін қараңыз немесе еліңіздегі тұтынушыларды қолдау орталығына хабарласыңыз.

Мәселе	Ықтимал себебі	Шешімі
Үтік киімнің қыртыстарын кетіре алмайды.	Үтіктегенде бу шықпайды.	Су ыдысын толтырып, бу сырғытпасын  күйіне қойыңыз.
Үтік бу шығармайды.	Ыдыстағы су жеткіліксіз.	Су ыдысына су құйыңыз.
	Бу сырғытпасы  күйіне қойылған.	Бу сырғытпасын  күйіне қойыңыз.
	Үтік бу шығару үшін жетерліктей ыстық емес.	Үтік қызып жатқан кезде, «үтік дайын» шамы үнемі жанып тұрады. Үтік пайдалануға дайын болғанда шам өшеді.

Үтіктеу кезінде су тамшылары киімге түседі.	Қысқа уақыт аралығында буды күшейту функциясын тым жиі қолданып жіберген боларсыз.	Көлденеңінен қойып, үтіктеуді жалғастыра беріңіз, ал буды күшейту функциясын қайтадан қолданардан бұрын кішкене кідіре тұрыңыз.
	Сіз ыдысының қақпағын дұрыстап жаппаған боларсыз.	Қақпақты «сырт» еткен дыбыс шыққанша басыңыз.
Үтік бу ағымын шығармайды.	Мүмкін сіз қысқа уақыт аралығында бу ағымы функциясын тым жиі қолданып жіберген боларсыз.	Көлденеңінен қойып, үтіктеуді жалғастыра беріңіз, ал буды күшейту функциясын қайтадан қолданардан бұрын кішкене кідіре тұрыңыз.
	Үтік үтіктеу үшін жетерліктей ыстық емес.	«Үтік дайын» шамы жыпылықтауын тоқтатып, үздіксіз жанғанша күтіңіз.
	Су ыдысына химиялық зат қосып жіберген боларсыз.	Су ыдысын шайыңыз және су ыдысына ешбір иіссү немесе химиялық заттар құймаңыз.
Үтікті токтан суырып қойғаннан кейін үтіктің табанынан су тамшылап тұр.	Бу сырғытпасы  күйіне қойылған.	Бу сырғытпасын  күйіне қойыңыз.
	Сіз үтікті, ішінде суы бола тұра, көлбеу ұстанымына қойған боларсыз.	Пайдаланғаннан кейін су ыдысын босатыңыз немесе үтікті тігінен қойыңыз.
Үтік киімде жылтыр із немесе белгі қалдырады.	Үтіктелетін бет тегіс емес, мысалы, қатты бумен үтіктеп жатқандықтан немесе киімде бүктелген жер болғандықтан.	Үтікті барлық үтіктеуге болатын киімдерде қауіпсіз пайдалануға болады. Жылтыр тұрақты емес және киімді жуғанда жоғалады. Тігістер немесе бүктелген жерлер үстінен үтіктемеңіз. Сондай-ақ, жылтыр белгі қалдырмау үшін ол аумаққа мақта шүберек қоюға болады.

# Ներածություն

Շնորհավորում ենք գնման կապակցությամբ և բարի գալուստ Philips: Philips-ի առաջարկած աջակցությունից լիարժեք օգտվելու համար գրանցեք ձեր ապրանքն այստեղ՝ [www.philips.com/welcome](http://www.philips.com/welcome): Սաքըն օգտագործելուց առաջ կարդացեք այս ձեռնարկը, կարևոր տեղեկություններ պարունակող բուկլետը և համառոտ ուղեցույցը: Պահեք դրանք՝ հետագայում օգտվելու համար:

# Ապրանքի ընդհանուր բնութագիրը

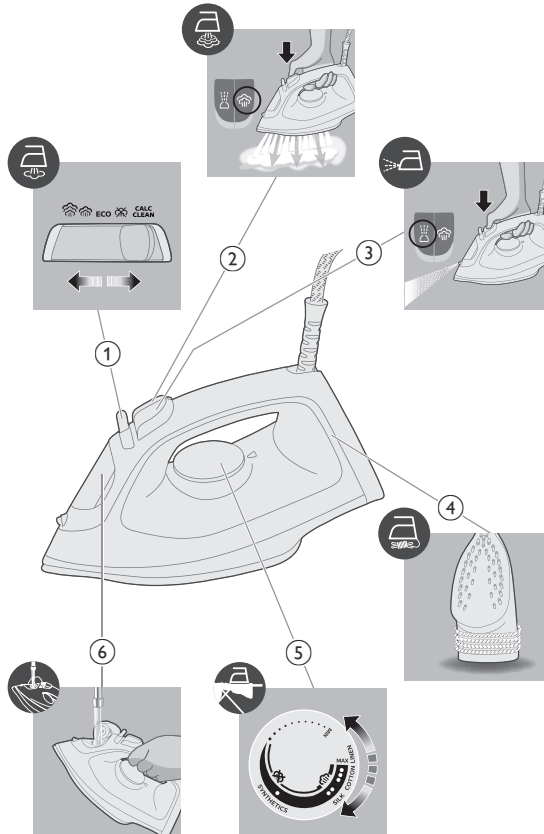

- 1 Գոլորշու մատակարարման ռեժիմի ընտրության կոճակ
- 2 Ուժեղ գոլորշու մղման կոճակ
- 3 Ջրի ցողացիր
- 4 Լարի խցիկ
- 5 Ջերմաստիճանի կարգավորիչ
- 6 Ջրի տարայի կափարիչ

## Սարքի օգտագործումը

### Նախապատրաստում

Նշում. Արդյուն անաջին անգամ օգտագործելիս հնարավոր է փոքր քանակությամբ գոլորշի արձակվի: Կարճ ժամանակ անց այն վերանում է:

#### Ինչ տեսակի ջուր պետք է օգտագործել

Սարքը հարմար է ծորակի ջրով օգտագործման համար: Սակայն, եթե դուք ապրում եք այնպիսի տարածքում, որտեղ ջրի կոշտության աստիճանը բարձր է, խորհուրդ ենք տալիս ծորակի ջուրը խառնել թորած կամ դեմիներալիզացված ջրի հետ հավասար քանակությամբ: Դա կկանխի նստվածքի կուտակումը և կերկարացնի սարքի կյանքը:

**Մի ավելացրեք օժանելիք, չորանոցի ջուր, քացախ, օսլա, նստվածքի մաքրման, արդուկման օժանդակ միջոցներ, քիմիական միջոցներով մաքրված ջուր կամ քիմիական այլ նյութեր, քանի որ դրանք կարող են առաջացնել ջրի ցայտեր, շագանակագույն բծեր կամ վնասել ձեր սարքը:**

### Ջրի խցիկի լցնումը

- 1 Մի միացրեք սարքը:

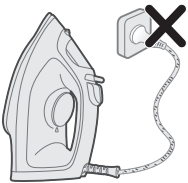



2 Համոզվեք, որ սարքը սառը լինի:

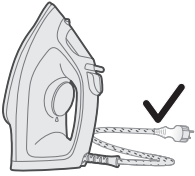

3 Առանց գոլորշու արդուկման ռեժիմն ընտրելու համար (չոր արդուկում) գոլորշու մատակարարման ռեժիմի ընտրության կոճակը թեքեք դեպի աջ :

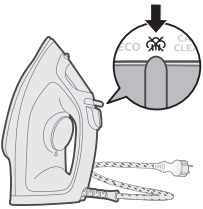

4 Շրջելով բացեք ջրի խցիկի կափարիչը:

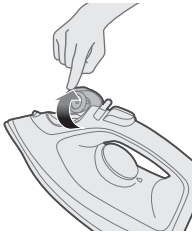

5 Ջրի խցիկը ցրեք մինչև ջրի խցիկի վրա նշված MAX նշագիծը:

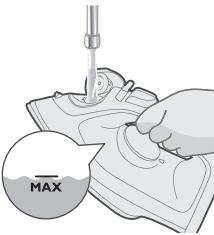

6 Անուր փակեք ջրի տարայի կափարիչը:

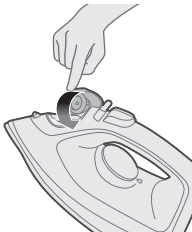

# Ինչպես կարգավորել ջերմաստիճանը



	MAX ՎՈՒՇ	
	● ● ● ԲԱՄԲԱԿ	
	● ● ՄԵՏԱՔՍ	<b>ECO</b>
	● ՍԻՆԹԵՏԻԿ ԳՈՐԾՎԱԾՔՆԵՐ	



ECO ռեժիմ. Գոլորշու նվազագույն քանակի անընդմեջ մատակարարում՝ քիչ ծախքեր ունեցող հագուստն արդյուկելու համար: Այս ռեժիմը նաև խնայում է էլեկտրաէներգիան:



Գոլորշու երկու ամպ. Գոլորշու ավելի շատ քանակի անընդմեջ մատակարարում՝ դժվար արդյուկվող ծալքերը հարթեցնելու համար:



Գոլորշու երեք ամպ. Գոլորշու առավելագույն քանակի անընդմեջ մատակարարում՝ չափազանց խորը ծալքերը հարթեցնելու համար:

## Սարքի օգտագործումը

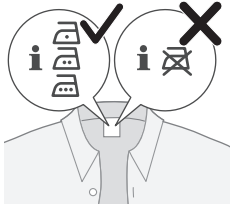

1 Ստուգեք հագուստի պիտակը՝ արդուկման անհրաժեշտ ռեժիմ կիրառելու համար:

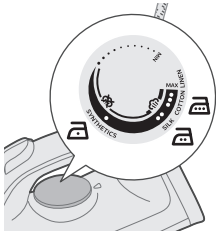

2 Ջերմաստիճանի ցուցիչը սահմանեք արդուկման պահանջվող ջերմաստիճանի վրա՝ ուղղելով այն ջերմաստիճանի համապատասխան նիշի վրա:

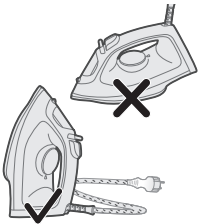

3 Թույլ տվեք, որ արդուկը մի փոքր տաքանա՝ դնելով այն կանգնած վիճակում՝ իր ոտնակի վրա:

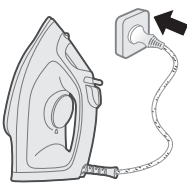

4 Հոսանքի լարը միացրեք հողանցված վարդակից:

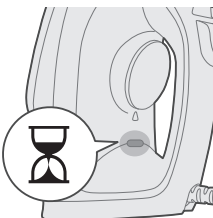

5 «Արդուկման պատրաստ» ցուցիչի լույսը կվառավի՝ ցույց տալով, որ արդուկը տաքանում է:

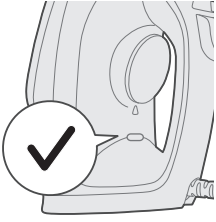

6 Երբ «Արդուկման պատրաստ» ցուցիչի լույսը հանգչում է, անմիջապես մի անցեք արդուկման՝ մի փոքր սպասեք: «Արդուկման պատրաստ» ցուցիչի լույսը ժամանակ առ ժամանակ կվառվի արդուկման ժամանակ:

### Առանց գոլորշու/չոր արդուկում

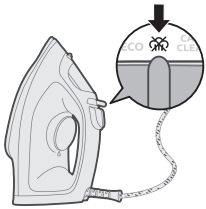

1 Գոլորշու կարգավորումը դրեք առանց գոլորշու արդուկման ռեժիմի վրա:

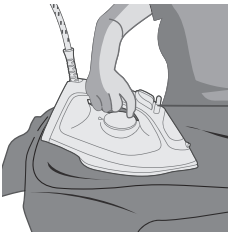

2 Կարձ ժամանակ անց՝ արդուկելիս գոլորշին կդադարի:

### Ջրի ցողացիր

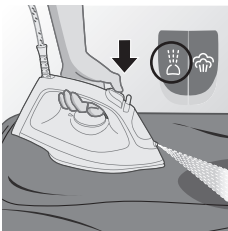

1 Գոլորշու կարգավորումը դրեք առանց գոլորշու արդուկման ռեժիմի վրա: Սեղմեք և բաց թողեք ջրի ցողացրման կոճակը՝ ձևափազանց դժվար արդուկվող ծալքերը հարթեցնելու համար:

## Գոլորշու ուժեղացում

1 Բամբակի և սպիտակեղենի արդուկման համար ջերմաստիճանի ցուցիչը սահմանեք MAX-ի վրա:

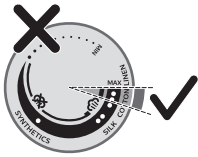

2 Ուժեղ գոլորշիով խորը ծալքերը հարթեցնելու համար սեղմեք և բաց թողեք գոլորշու մղման կոճակը:

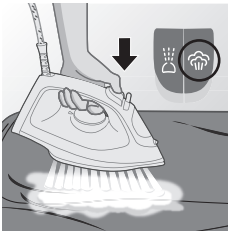

3 Դուք կարող եք օգտագործել «Ուժեղ գոլորշու մղման» գործառույթը, երբ արդուկը պահում եք ուղղահայաց դիրքով՝ կախված վիճակով հագուստի ծալքերը հարթեցնելու համար (միայն DST2020 և DST2030 դեպքում):

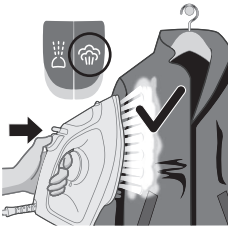

4 Խորը ծալքերը ուժեղ գոլորշու մղման կոճակով հարթեցնելիս՝ քաշելով ձգեք ձեր հագուստը (միայն DST2020 և DST2030 դեպքում):

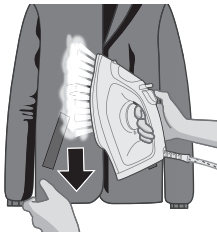

5 Արդուկելիս ձեր մերկ ձեռքը որպես հենման մակերես մի օգտագործեք:



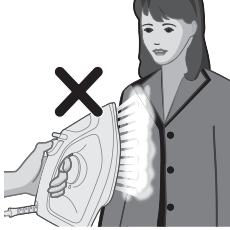

6 Մի պահեք սարքը ձեր կամ մեկ ուրիշի վրա:

### Ավտոմատ անջատման ռեժիմ (DST2030)



1 Որոշ ժամանակ առանց հսկողության մնալու դեպքում սարքն ինքնուրույն սառչում է՝ ապահովելով ձեր հանգստությունը:

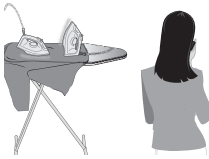

2 Սարքն ավտոմատ կերպով անցնում է անջատման ռեժիմի, եթե այն չի օգտագործվում՝ արդյունյալ մակերեսի վրա դրված վիճակում ավելի քան 30 վայրկյան կամ իր ոտնակի/հիմքի վրա 8 րոպե:

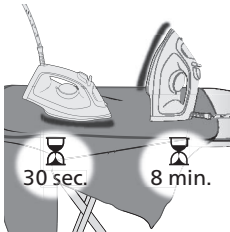

3 Ավտոմատ անջատման ռեժիմում սարքի ջերմաստիճանը նվազում է: «Արդյունյալ պատրաստ» ցուցիչի լույսը անդադար թարթում է՝ ցույց տալով, որ սարքն ավտոմատ կերպով անջատվել է: Սարքն ամբողջությամբ անջատելու համար անջատեք այն էլեկտրական վարդակից:

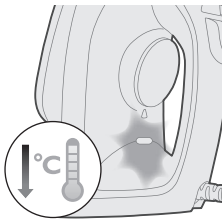

4 Որպեսզի սարքը նորից տաքանա, վերցրեք սարքը կամ թեթևակի շարժեք այն:

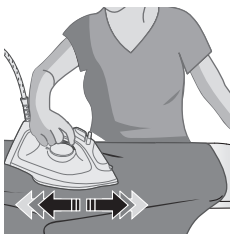

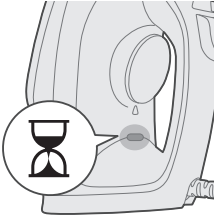

5 «Արդուկման պատրաստ» ցուցիչի լույսը կվառվի՝ ցույց տալով, որ սարքը տաքանում է:

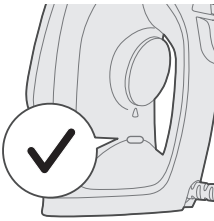

6 Սարքը պատրաստ է օգտագործման համար, երբ «Արդուկման պատրաստ» ցուցիչի լույսը մարվում է:

## Մաքրում և տեխնիկական սպասարկում

1 Հանոզվեք, որ սարքը միացված չէ վարդակին:

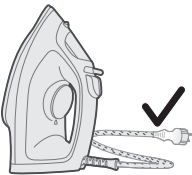
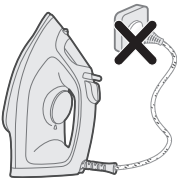

2 Հանոզվեք, որ սարքը սառել է:

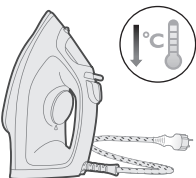

## 600 Հայերեն

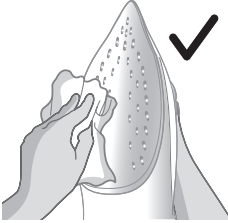

- 3 Խոնավ շորով արդուկի տակի հատվածից հեռացրեք նստվածքը և այլ մնացորդներ:



Նշում. Արդուկող մակերեսը հարթ պահելու համար խորհուրդ է տրվում խուսափել մետաղական առարկաների հետ կոշտ շփումից: Արդուկի տակի հատվածի մաքրման համար երբեք մի օգտագործեք մետաղական պարույրով սպունգ, քացախ կամ այլ քիմիական նյութեր:

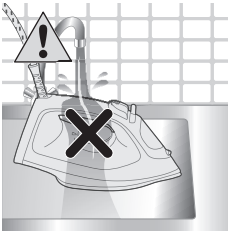

- 4 Սարքը մի լվացեք/մաքրեք հոսող ջրի տակ:

## Calc-Clean նստվածքի մաքրման գործառույթ

Խորհուրդ. Արագ Calc Release նստվածքի մաքրման գործառույթը կարող է օգտագործվել ցանկացած պահի: Եթե ապրում եք այնպիսի տարածքում, որտեղ ջրի կոշտության աստիճանը բարձր է, այս ֆունկցիան ավելի հաճախ օգտագործեք:



- 1 Calc clean նստվածքի մաքրման գործառույթը խորհուրդ է տրվում կիրառել օգտագործումից 1 ամիս անց՝ ձեր սարքից նստվածքի կուտակումները հեռացնելու համար՝ երկարացնելով դրա երկարակեցությունն ու ապահովելով սարքի տաքացումը:



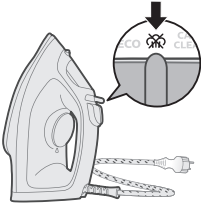

2 Համոզվեք, որ արդուկն անջատված լինի վարդակից, և գոլորշու կարգավորումը դրված լինի առանց գոլորշու արդուկման ռեժիմի (չոր արդուկում) վրա ~~0~~:

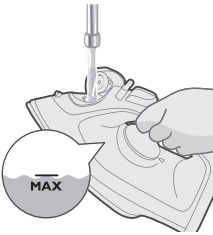

3 Ջրի խցիկը լցրեք մինչև MAX նշագիծը:



4 Ջերմաստիճանի ցուցիչը դրեք MAX-ի վրա:

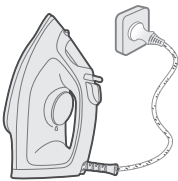

5 Սարքը պետք է միացնել հողանցված վարդակին:

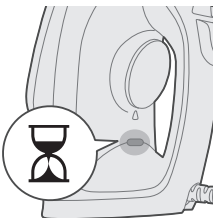

6 «Արդուկման պատրաստ» ցուցիչի լույսը կվառվի՝ ցույց տալով, որ սարքը տաքանում է:

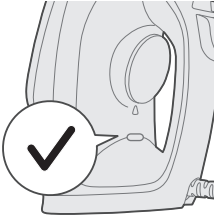

7 Սպասեք մինչև «Արդուկման պատրաստ» ցուցիչի լույսն անջատվի:

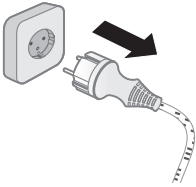

8 Արդուկն անջատեք:

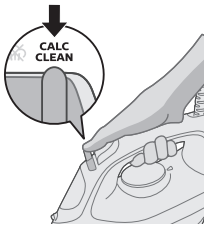

9 Գոլորշու կարգավորիչը դրեք Calc-Clean դիրքի վրա և այդպես պահեք:



10 Արդուկը պահեք լվացարանի վրա և զգուշորեն թափահարեք այն: Տաք ջուրը և նստվածքի մասնիկները կթափվեն արդուկի մակերեսից:

Զգուշացում. Նստվածքի մաքրման ժամանակ մակերեսից դուրս կգա նաև գոլորշի և եռացող ջուր:

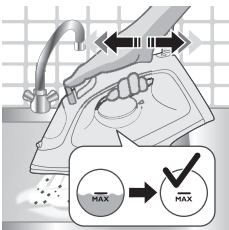

11 Շարունակեք թափահարել արդուկը, մինչև ջրի խցիկի ամբողջ ջուրը սպառվի:

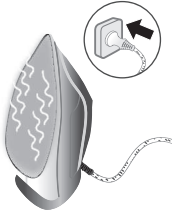

12 Միացրեք սարքը վարդակին և թողեք այն տաքանա, որպեսզի արդուկի տակի հատվածը չորանա: Դրա համար կպահանջվի մոտ 2 րոպե:

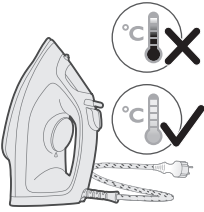

13 Թողեք արդուկը սառչի:

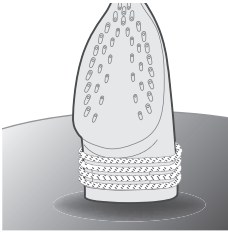

14 Լարը փաթաթեք արդուկի ոտնակի շուրջը:

## Պահումը

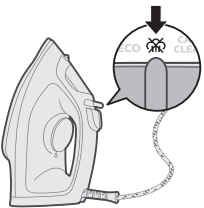

1 Առանց գոլորշու արդուկման ռեժիմն ընտրելու համար (չոր արդուկում) սահեցրեք գոլորշու մատակարարման ռեժիմի ընտրության կոճակը ~~ON~~:

2 Անջատեք սարքը վարդակից:

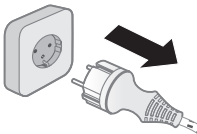

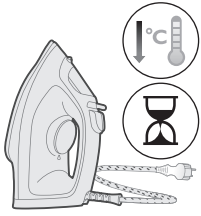

3 Թողեք, որ սարքն ամբողջությամբ սառչի:

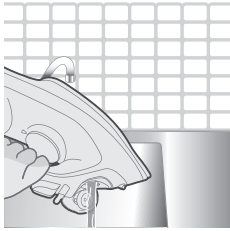

4 Ջրի խցիկից թափեք մնացած ջուրը:

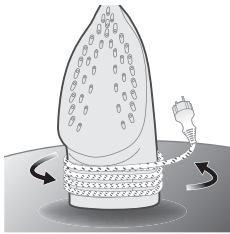

5 Հոսանքի լարը փաթաթեք սարքի շուրջը:

## Անսարքությունների ուղղում

Այս գլխում ներկայացված են ամենատարածված խնդիրները, որոնք կարող են հանդիպել սարքի օգտագործման ժամանակ: Եթե չեք կարողանում խնդիրը լուծել ստորև բերված տեղեկատվության օգնությամբ, այցելեք [www.philips.com/support](http://www.philips.com/support) հաճախակի տրվող հարցերի համար կամ դիմեք ձեր երկրում գործող Հաճախորդների սպասարկման կենտրոն:

Խնդիր	Հնարավոր պատճառ	Լուծում
Արդուկը չի կարողանում հարթեցնել հագուստի ծալքերը:	Արդուկման ժամանակ գոլորշի դուրս չի գալիս:	Ջուր լցրեք ջրի խցիկի մեջ և գոլորշու մատակարարման փոխարկիչը դրեք  ռեժիմի վրա:
Արդուկը գոլորշի չի արձակում:	Ջրի խցիկի մեջ բավարար քանակությամբ ջուր չկա:	Ջուր լցրեք խցիկի մեջ:
	Գոլորշու մատակարարման փոխարկիչը դրված է :	Գոլորշու մատակարարման փոխարկիչը դրեք :

	Արդուկը դեռ այնքան տաք չէ, որպեսզի գոլորշի մատակարարի:	Մինչ սարքը տաքանում է, «Արդուկման պատրաստ» ցուցիչի լույսն անթարթ վառվում է: Երբ սարքը պատրաստ է օգտագործման, լույսն անջատվում է:
Արդուկելու ժամանակ արդուկից ջրի կաթիլներ են կաթում հագուստի վրա:	Ձեր կողմից գոլորշու մղման գործառնայթի օգտագործումը չափազանց հաճախակի է եղել կարճ ժամանակահատվածում:	Շարունակեք արդուկել հորիզոնական դիրքով և մի փոքր սպասեք, մինչև նորից կկարողանաք օգտագործել գոլորշու մղման ֆունկցիան:
	Դուք կարգին չեք փակել ջրի խցիկի կափարիչը:	Այնպես փակեք կափարիչը, որպեսզի կտտոցի ձայն լսվի:
Արդուկը գոլորշու մղում չի կատարում:	Կարճ ժամանակահատվածում դուք շատ հաճախ եք օգտագործել գոլորշու մղման ֆունկցիան:	Շարունակեք արդուկել հորիզոնական դիրքով և մի փոքր սպասեք, մինչև նորից կկարողանաք օգտագործել գոլորշու մղման ֆունկցիան:
	Արդուկը դեռ բավականաչափ տաք չէ արդուկելու համար:	Սպասեք, մինչև «Արդուկման պատրաստ» ցուցիչի լույսն այլևս չթարթի և սկսի կայուն վառվել:
	Դուք քիմիական նյութ եք լցրել ջրի խցիկի մեջ:	Լվացեք ջրի խցիկը և մի ավելացրեք այնտեղ բուրավետիչներ կամ քիմիական նյութեր:
Արդուկի տակի հատվածից ջուր է կաթում՝ արդուկն էլեկտրասնուցման վարդակից անջատելուց հետո:	Գոլորշու մատակարարման փոխարկիչը դրված է  :	Գոլորշու մատակարարման փոխարկիչը դրեք  :
	Դուք արդուկը դրել եք հորիզոնական դիրքով, իսկ ջրի խցիկում դեռ ջուր է մնացել:	Օգտագործելուց հետո դատարկեք ջրի խցիկը կամ արդուկը պահեք ուղղահայաց դիրքով:
Արդուկը օգտագործելուց հետո կտորի վրա փայլ կամ արդուկի հետք է մնում:	Արդուկվող մակերեսը եղել է անհարթ, օրինակ՝ արդուկումը կատարվել է կարի կամ հագուստի ծավաճքի վրայով:	Արդուկը անվտանգ է օգտագործել արդուկվող բոլոր գործվածքների համար: Փայլը կամ արդուկի հետքերը մշտական չեն և անհետանում են հագուստը լվանալուց հետո: Մի արդուկեք կարի կամ հագուստի ծավաճքի վրայով: Հագուստի վրա հետքերից խուսափելու համար կարող եք արդուկվող հատվածի վրա բամբակյա կտոր դնել:

## ข้อมูลเบื้องต้น

ขอแสดงความยินดีที่คุณเลือกซื้อผลิตภัณฑ์ของเรา และยินดีต้อนรับสู่ Philips เพื่อให้คุณได้รับประโยชน์อย่างเต็มที่จากบริการที่ Philips มอบให้ โปรดลงทะเบียนผลิตภัณฑ์ของคุณที่ [www.philips.com/welcome](http://www.philips.com/welcome) โปรดอ่านคู่มือผู้ใช้นี้ เอกสารข้อมูลสำคัญ และคู่มือเริ่มต้นใช้งานอย่างย่อโดยละเอียดก่อนใช้งานผลิตภัณฑ์ และเก็บไว้เพื่ออ้างอิงต่อไป

## ภาพรวมของผลิตภัณฑ์

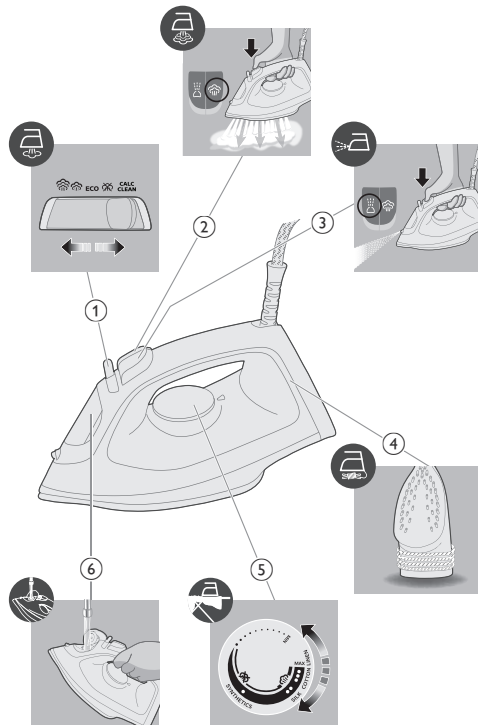

- 1 ตัวเลือกไอน้ำ
- 2 ปุ่มเพิ่มพลังไอน้ำ
- 3 สเปร์ยละอองน้ำ
- 4 การพันเก็บสายไฟ
- 5 ปุ่มปรับอุณหภูมิ
- 6 ฝาแกงค์น้ำ

## การใช้เครื่อง

### การเตรียมตัวก่อนใช้งาน

หมายเหตุ:

อาจมีไอน้ำเล็กน้อยออกมาจากเตารีดเมื่อคุณใช้งานเครื่องในครั้งแรก.  
ควันจะหายไปเมื่อผ่านไปครู่หนึ่ง

#### ชนิดของน้ำที่ใช้งาน

เครื่องเหมาะสำหรับใช้งานกับน้ำประปา อย่างไรก็ตาม

หากคุณอาศัยอยู่ในพื้นที่ที่น้ำกระด้างมาก

เราขอแนะนำให้คุณผสมน้ำประปาในปริมาณที่เท่ากับน้ำกลั่นหรือน้ำปราศจากแร่ธาตุ

ซึ่งจะช่วยป้องกันไม่ให้เกิดตะกรันสะสมอย่างรวดเร็วและยืดอายุการใช้งานของเครื่อง

---

**อย่าใส่น้ำหอม น้ำจากเครื่องอบผ้า น้ำส้มสายชู แป้ง**

**น้ำยาขจัดคราบตะกรัน น้ำยารีดผ้าเรียบ**

**น้ำที่ผ่านการขจัดตะกรันด้วยสารเคมี หรือสารเคมีอื่นๆ**

**เนื่องจากอาจทำให้น้ำกระเด็น เกิดคราบสีน้ำตาล**

**หรือทำให้เครื่องเสียหายได้**

---

## การเติมน้ำลงในแท่งค์

1 อย่าเสียบปลั๊กไฟเครื่อง

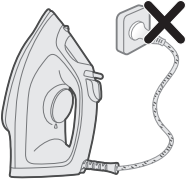

2 ตรวจสอบให้แน่ใจว่าเครื่องเย็นลงแล้ว

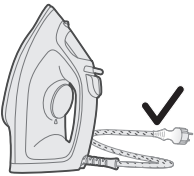

3 เลื่อนตัวเลือกไอน้ำไปทางขวาเพื่อเลือกโหมดไม่ใช้ไอน้ำ (รีดผ้าแบบแห้ง) 

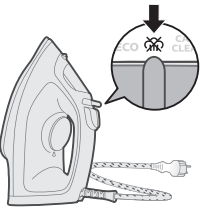

4 พลิกเปิดฝาแท่งค์น้ำ

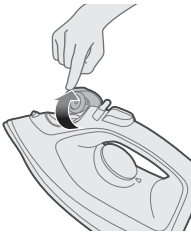

5 เติมน้ำลงในแท่งค์น้ำจนถึงขีดบอกระดับสูงสุด

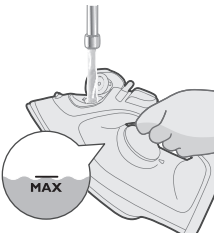





## 6 ปิดฝาแท็งค์น้ำให้แน่น

### การตั้งอุณหภูมิ



	ระดับสูงสุด ลินิน	☞/☞
	● ● ● ผ้าฝ้าย	☞/☞
	● ● ผ้าไหม	<b>ECO</b>
	● ผ้าใยสังเคราะห์	☞

ECO



การตั้งค่า ECO:

พลังไอน้ำคงที่ขึ้นต่ำจะถูกปล่อยออกมาอย่างต่อเนื่องสำหรับเสื้อผ้าที่มีรอยยับน้อย การตั้งค่านี้ยังช่วยลดพลังงานอีกด้วย

## 610 ภาษาไทย



เมฆไอน้ำสองก้อน:

พลังไอน้ำสม่ำเสมออย่างขึ้นถูกปล่อยออกมาอย่างต่อเนื่องสำหรับรอยยับที่-  
รีดยาก



เมฆไอน้ำสามก้อน:

พลังไอน้ำสม่ำเสมอขึ้นที่สูงที่สุดจะถูกปล่อยออกมาอย่างต่อเนื่องเพื่อขจัดรอย-  
ยับที่รีดยากมาก

## การใช้เครื่อง

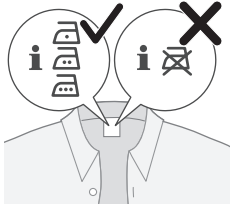

1 ตรวจสอบดูฉลากเสื้อผ้าเพื่อดูรูปแบบการรีดผ้าที่ต้องใช้

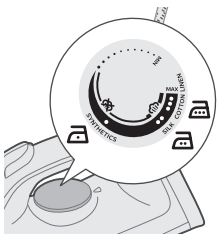

2 ตั้งปุ่มหมุนอุณหภูมิไปที่อุณหภูมิการรีดผ้าที่ต้องการโดยหมุนไปที่ตัว-  
แสดงอุณหภูมิที่เหมาะสม

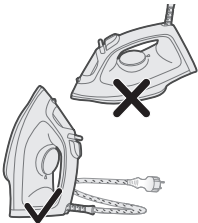

3 พักเตารีดในแนวตั้ง

4 เสียบปลั๊กไฟเข้ากับเต้ารับติดตั้งที่ต่อสายดินไว้เรียบร้อยแล้ว

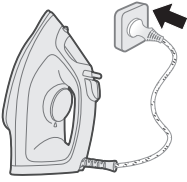

5 ไฟแสดงความพร้อมใช้งานของเตารีดจะสว่างขึ้นเพื่อแสดงว่าเตารีดกำลังร้อน

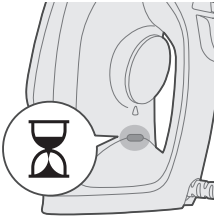

6 เมื่อไฟแสดงความพร้อมใช้งานของเตารีดดับลงให้รอสักครู่ก่อนเริ่มรีดผ้า  
ไฟแสดงความพร้อมใช้งานจะสว่างขึ้นเป็นครั้งคราวระหว่างการรีดผ้า

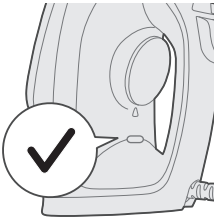

## ไม่ใช่ไอน้ำ/รีดผ้าแบบแห้ง

1 ตั้งการตั้งค่าไอน้ำเป็นแบบไม่ใช่ไอน้ำ

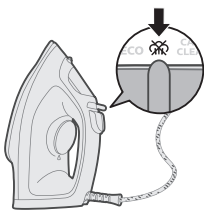

2 หลังจากนั้นไม่นาน ไอน้ำจะหยุดลงระหว่างรีดผ้า

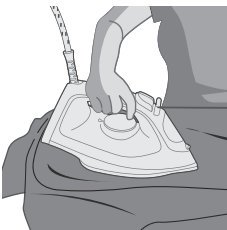

## สเปรย์ละอองน้ำ

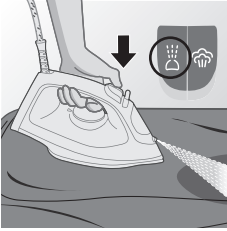

- 1 ตั้งการตั้งค่าไอน้ำเป็นแบบไม่ใช้ไอน้ำ กดและปล่อยปุ่มสเปรย์ละอองน้ำ เพื่อใช้ไอน้ำจัดรอยยับที่รีดยาก

## เพิ่มพลังไอน้ำ

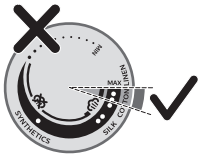

- 1 ตั้งปุ่มหมุนอุณหภูมิไปที่การตั้งค่าระดับสูงสุดระหว่างรีดผ้าฝ้ายและผ้าลินิน



- 2 กดและปล่อยปุ่มเพิ่มพลังไอน้ำเพื่อเพิ่มพลังไอน้ำอันทรงพลังเพื่อจัดรอยยับที่รีดยาก

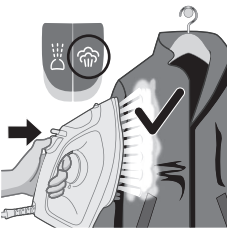

- 3 คุณสามารถใช้ฟังก์ชันเพิ่มพลังไอน้ำได้เมื่อคุณถือเตารีดในแนวตั้งเพื่อจัดรอยยับออกจากเสื้อผ้าที่แขวนอยู่ (สำหรับรุ่น DST2020 และ DST2030 เท่านั้น)

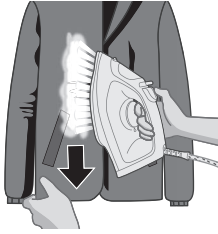

4 ดึงและยึดเสื้อผ้าของคุณพร้อมกับเพิ่มพลังไอน้ำเพื่อจัดรอยยับที่รีดยาก (สำหรับรุ่น DST2020 และ DST2030 เท่านั้น)



5 อย่าใช้มือเปล่ารองพื้นผิวเมื่อคุณใช้ไอน้ำ

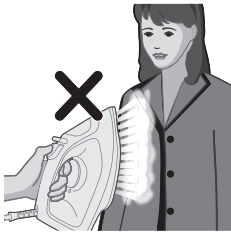

6 อย่าวางหันเครื่องเข้าหาตัวคุณ/บุคคลอื่น

## ระบบตัดไฟอัตโนมัติ (DST2030)



1 เพื่อให้คุณอุ่นใจได้ เครื่องจะเย็นลงเองหากปล่อยทิ้งไว้โดยไม่มีใครใช้งานเป็นระยะเวลาหนึ่ง

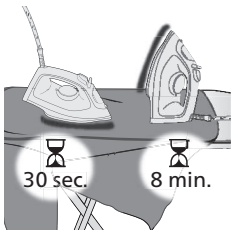

2 เมื่อไม่ได้ใช้งานเครื่องนานกว่า 30 วินาทีโดยวางบนแผ่นความร้อน หรือ 8 นาทีโดยวางแนวตั้ง/ บนฐาน เครื่องจะเข้าสู่โหมดตัดไฟอัตโนมัติ

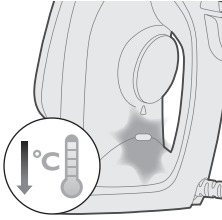

3 อุณหภูมิของเครื่องจะลดลงในโหมดตัดไฟอัตโนมัติ ไฟแสดงความพร้อมใช้งานของเตารีดจะกะพริบไม่หยุดเพื่อระบุว่าเครื่องอยู่ในสถานะตัดไฟอัตโนมัติ หากต้องการปิดเครื่องโดยสมบูรณ์ให้ถอดปลั๊กไฟเครื่องออกจากเต้ารับ

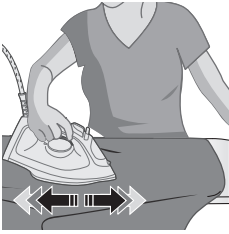

4 หากต้องการให้เครื่องร้อนขึ้นอีกครั้งให้หยิบเครื่องขึ้นมาหรือขยับเครื่องเล็กน้อย

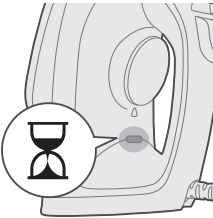

5 ไฟแสดงความพร้อมใช้งานจะสว่างขึ้นเพื่อแสดงว่าเครื่องกำลังร้อน

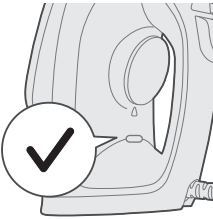

6 เมื่อไฟแสดงความพร้อมใช้งานของเตารีดดับลง แสดงว่าเครื่องพร้อมใช้งาน

# การทำความสะอาดและบำรุงรักษา

1 ตรวจสอบให้แน่ใจว่าไม่ได้เสียบปลั๊กเครื่องไว้

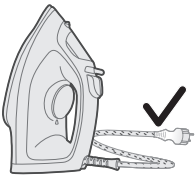
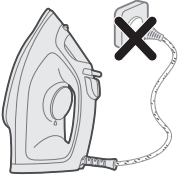

2 ตรวจสอบให้แน่ใจว่าเครื่องเย็นลงแล้ว

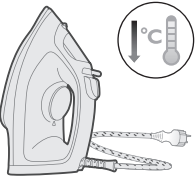

3 เช็ดสะเก็ดและสิ่งตกค้างอื่นๆ  
ออกจากแผ่นความร้อนด้วยผ้าชุบน้ำหมาด

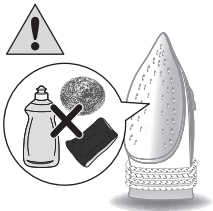

หมายเหตุ: เพื่อรักษาแผ่นความร้อนให้เรียบสัณ  
ให้หลีกเลี่ยงการสัมผัสกับวัตถุที่เป็นโลหะ ห้ามใช้แผ่นขัดถู น้ำส้มสายชู  
หรือสารเคมีอื่นๆ ในการทำความสะอาดแผ่นความร้อน



#### 4 ห้ามล้าง/ทำความสะอาดเครื่องไต้ผ้าไหล

### ขจัดคราบตะกรัน

เคล็ดลับ: สามารถใช้ฟังก์ชันสลายคราบตะกรันด่วนได้ตลอดเวลา หากคุณอาศัยอยู่ในบริเวณที่มีน้ำกระด้าง ให้ใช้ฟังก์ชันนี้อย่างสม่ำเสมอ



#### 1 หลังจากใช้งานไป 1 เดือน

ขอแนะนำให้ทำความสะอาดคราบตะกรันเพื่อขจัดตะกรันที่สะสมออกจากเครื่องใช้ไฟฟ้าของคุณ เพื่อยืดอายุการใช้งานและให้แน่ใจว่าเครื่องจะทำความร้อนได้

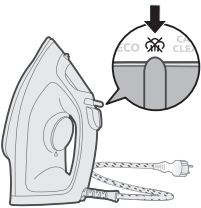

#### 2 ตรวจสอบให้แน่ใจว่าได้ถอดปลั๊กแล้ว

และตั้งค่าไอน้ำเป็นโหมดไม่ใช้ไอน้ำ (รีดผ้าแบบแห้ง) 

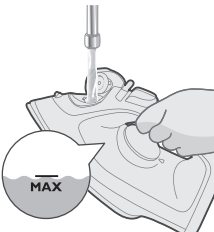

#### 3 เติมน้ำประปาลงในแท็งก์น้ำจนถึงระดับสูงสุด





4 ตั้งปุ่มหมุนอุณหภูมิไปที่ระดับสูงสุด

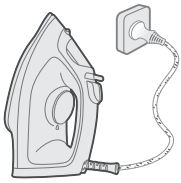

5 เสียบปลั๊กไฟเข้ากับเตารีดติดผนังที่ต่อสายดินไว้เรียบร้อยแล้ว

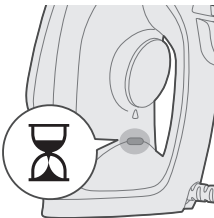

6 ไฟแสดงความพร้อมใช้งานจะสว่างขึ้นเพื่อแสดงว่าเครื่องกำลังร้อน

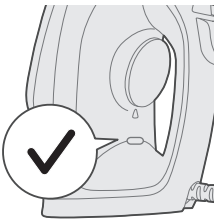

7 รอนกว่าไฟแสดงความพร้อมใช้งานของเตารีดจะดับลง

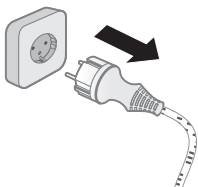

8 ถอดปลั๊กเตารีด

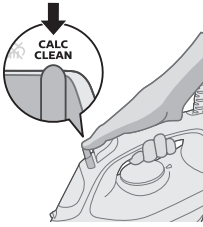

9 เลื่อนตัวเลือกไอน้ำไปที่ตัวเลือกขจัดคราบตะกรันค้างไว้



10 ล้อเตารีดไว้เหนืออ่างแล้วเขย่าเตารีดเบาๆ  
น้ำร้อนและอนุภาคคราบตะกรันจะหลุดออกจากแผ่นความร้อน  
ข้อควรระวัง: ในขณะที่ขจัดคราบตะกรันออกไป  
ไอน้ำและน้ำเดือดก็จะออกมาจากแผ่นทำความร้อนด้วย

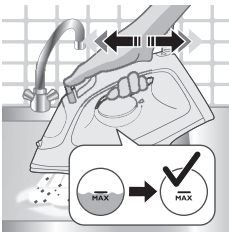

11 เขย่าเตารีดต่อไปจนกว่าน้ำในแท็งก์น้ำจะไหลออกหมด

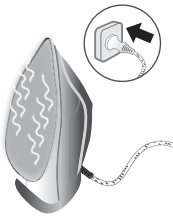

12 เสียบปลั๊กเครื่องและปล่อยให้เครื่องร้อนเพื่อทำให้แผ่นความร้อนแห้ง  
ขั้นตอนนี้ใช้เวลาประมาณ 2 นาที

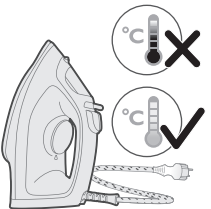

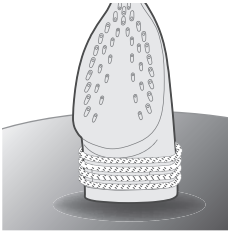

13 ปล่อยให้เตารีดเย็นลง

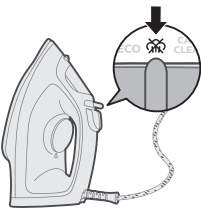

## 14 ม้วนสายไฟรอบฐานของตัวเครื่อง

### การจัดเก็บ



1 เลื่อนตัวเลือกไอน้ำเพื่อเลือกโหมดไม่ใช้ไอน้ำ (รีดผ้าแบบแห้ง) 

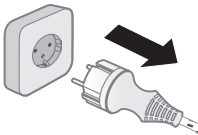

2 ถอดปลั๊กเครื่อง

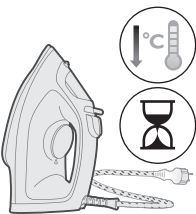

3 ปลดปล่อยให้เครื่องเย็นลง

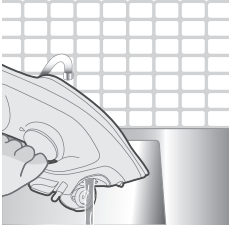

#### 4 เหน้ที่เหลือออกจากแท่งค้เก็บน้ำ

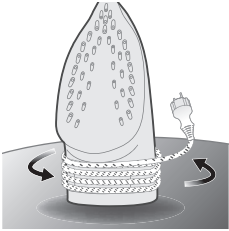



#### 5 ม้วนสายไฟรอบตัวเครื่อง

## การแก้ไขปัญหา

ในบทนี้ เราได้รวบรวมปัญหาต่างๆ ที่อาจเกิดขึ้นกับเครื่องได้ หากคุณไม่สามารถแก้ปัญหาด้วยข้อมูลด้านล่างได้ โปรดดูรายการคำถามที่พบบ่อยที่ [www.philips.com/support](http://www.philips.com/support) หรือติดต่อศูนย์บริการลูกค้าในประเทศของคุณ

ปัญหา	สาเหตุที่เป็นไปได้	วิธีแก้ปัญหา
เตารีดไม่สามารถจัดรอยยับออกจากเสื้อผ้าได้	ไม่มีไอน้ำพุ่งออกมาระหว่างรีดผ้า	เติมน้ำลงในแท่งค้แล้วตั้งค่าแถบเลื่อนไอน้ำไปที่
เตารีดไม่สร้างไอน้ำ	มีน้ำในแท่งค้ไม่เพียงพอ	เติมน้ำลงในแท่งค้
	แถบเลื่อนไอน้ำตั้งค่าไปที่	ตั้งค่าแถบเลื่อนไอน้ำไปที่
	เตารีดยังร้อนไม่พอที่จะทำให้เกิดไอน้ำ	เมื่อเตารีดกำลังร้อนขึ้น ไฟ "พร้อมสำหรับรีดผ้า" จะสว่างตลอดเวลา เมื่อเตารีดพร้อมใช้งาน ไฟจะดับลง

มีหยดน้ำหยดลงบนเสื้อผ้าหรือรองเท้ารีดผ้า	คุณใช้ฟังก์ชันเพิ่มพลังไอน้ำบ่อยเกินไปในช่วงเวลาสั้นๆ	รีดผ้าต่อในแนวอนและรอสักครู่ก่อนจึงจะใช้ฟังก์ชันเพิ่มพลังไอน้ำอีกครั้ง
	คุณปิดฝาแทงค์น้ำไม่ถูกต้อง	กดฝาลงจนกว่าคุณจะได้ยินเสียง 'คลิก'
เตารีดไม่เพิ่มพลังไอน้ำ	คุณใช้ฟังก์ชันเพิ่มพลังไอน้ำบ่อยเกินไปในช่วงเวลาสั้นๆ	รีดผ้าต่อในแนวอนและรอสักครู่ก่อนจึงจะใช้ฟังก์ชันเพิ่มพลังไอน้ำอีกครั้ง
	เตารีดร้อนไม่พอสำหรับการรีดผ้า	รอนกระแทงไฟ "พร้อมสำหรับรีดผ้า" หยุดกะพริบและสว่างอย่างต่อเนื่อง
	คุณได้ใส่สารเคมีลงในแทงค์น้ำ	ล้างแทงค์น้ำและอย่าใส่น้ำหอมหรือสารเคมีใดๆ ลงในแทงค์
น้ำหยดจากแผ่นทำความร้อนหลังจากถอดปลั๊กเตารีดแล้ว	แถบเลื่อนไอน้ำตั้งค่าไปที่ 	ตั้งค่าแถบเลื่อนไอน้ำไปที่ 
	คุณวางเตารีดในแนวอนโดยยังมีน้ำเหลืออยู่ในแทงค์น้ำ	เทน้ำออกจากแทงค์น้ำหลังการใช้งาน หรือเก็บเตารีดไว้ในแนวตั้ง
เตารีดทำให้ผ้าที่รีดเป็นเงาและมีรอยกด	พื้นผิวบริเวณที่รีดไม่เรียบ เช่น คุณอาจรีดผ้าบนรอยตะเข็บหรือมีผ้าพับซ้อนกัน	เตารีดปลอดภัยสำหรับเสื้อผ้าที่รีดได้ทุกชนิด เงาหรือรอยกดบนผ้าไม่ใช่รอยถาวรและจะหายไปเมื่อคุณซักผ้า หลีกเลี่ยงการรีดทับรอยตะเข็บหรือรอยพับ คุณยังสามารถวางผ้าฝ้ายไว้บนพื้นที่ที่จะรีดเพื่อหลีกเลี่ยงรอยประทับ

# შესავალი

მოგესალმებით Philips და გილოცავთ ახალ შენაძენს! Philips-ის მხარდაჭერით სრულად სარგებლობისთვის თქვენი პროდუქტი დაარეგისტრირეთ აქ: [www.philips.com/welcome](http://www.philips.com/welcome). მოწყობილობის გამოყენებამდე ყურადღებით ნაიკითხეთ წინამდებარე მომხმარებლის სახელმძღვანელო, მნიშვნელოვანი საინფორმაციო ბროშურა და მოკლე პრაქტიკული სახელმძღვანელო. შეინახეთ იგი მომავალში გამოსაყენებლად.

# პროდუქტის აღწერა

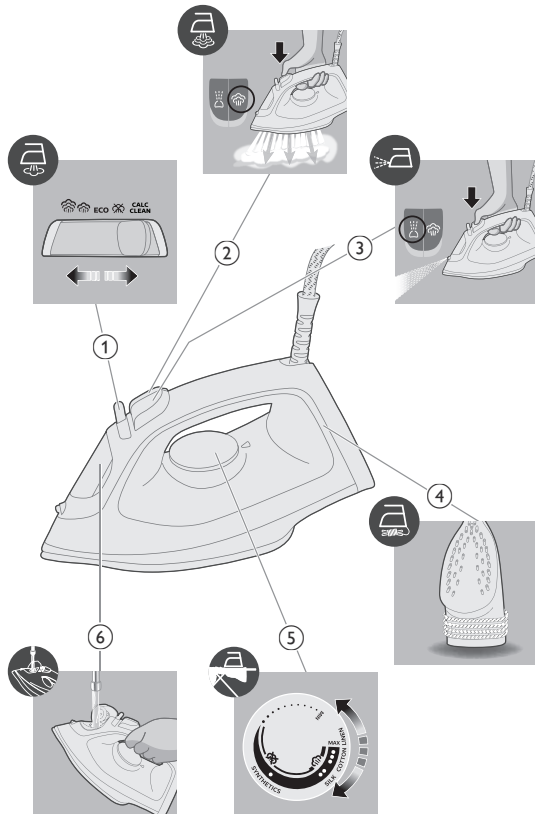

- 1 ორთქლის ასარჩევი ღილაკი
- 2 ორთქლის მოწოდების გაძლიერების ღილაკი
- 3 წყლის შესხურება
- 4 კაბელის განყოფილება
- 5 ტემპერატურის მარეგულირებელი
- 6 წყლის რეზერვუარის სახურავი

## მონყობილობის გამოყენება

### გამოსაყენებლად მომზადება

შენიშვნა: პირველად გამოყენებისას უთომ შეიძლება ცოტა ორთქლი გამოყოს. ის ცოტა ხანში გაქრება.

#### გამოსაყენებელი წყლის ტიპი

მონყობილობაში დასაშვებია ონკანის წყლის გამოყენება. თუმცა, თუ ხისტი წყლის მქონე რეგიონში ცხოვრობთ, რეკომენდებულია ონკანის წყლისა და გამოხდილი ან დემინერალიზებული წყლის თანაბარი ოდენობებით მიღებული ნარევის გამოყენება. ეს დაგეხმარებათ ნალექის დაგროვების თავიდან აცილებაში და მონყობილობის მუშაობის ვადას გაახანგრძლივებს.

**არ დაამატოთ სუნამო, საშრობის წყალი, ძმარი, სახამებელი, ნალექისგან გამწმენდი საშუალებები, დაუთობის დამხმარე საშუალებები, ნალექისგან ქიმიურად გასუფთავებული წყალი ან სხვა ქიმიური ნივთიერებები, რადგან ამან შეიძლება გამოიწვიოს წყლის გაჟონვა, ყავისფრად დალაქავება ან მონყობილობის დაზიანება.**

### წყლის რეზერვუარის შევსება

- 1 არ შეაერთოთ მონყობილობა ელექტროქსელში.

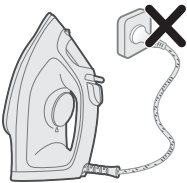

2 დარწმუნდით, რომ მოწყობილობა გაგრილებულია.

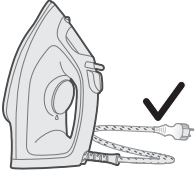

3 გადაწიეთ ორთქლის გამომშვების ასარჩევი ღილაკი მარჯვნივ, ორთქლის გარეშე რეჟიმის ასარჩევად.

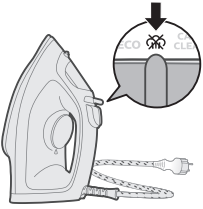

4 წყლის რეზერვუარის თავსახური გახსენით.

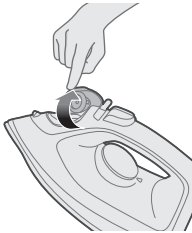

5 შეავსეთ წყლის რეზერვუარი მასზე არსებულ MAX ნიშნულამდე.

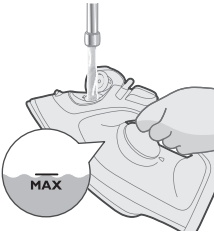

6 მყარად დაახურეთ წყლის რეზერვუარის თავსახური.

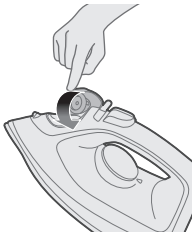



## ტემპერატურის დაყენება



	MAX სელის ტილო	
	● ● ● ბამბა	
	● ● აბრეშუმი	<b>ECO</b>
	● სინთეტიკა	



ECO პარამეტრი: ორთქლის მინიმალური რაოდენობის მუდმივი მიწოდება მცირე ნაკეცების გასასწორებლად. ეს რეჟიმი ზოგავს ელექტროენერჯიას.



ორი ორთქლის ღრუბელი: მეტად ინტენსიური ორთქლის მიწოდება ხისტი ნაკეცების გასასწორებლად.



სამი ორთქლის ღრუბელი: ორთქლის მაქსიმალური რაოდენობის მუდმივი მიწოდება ჩამჭდარი ნაკეცების გასასწორებლად.

## მონყობილობის გამოყენება

1 სათანადო დაუთოებისთვის შეამოწმეთ ტანსაცმლის იარლიყი.

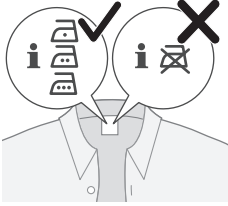

2 ტემპერატურის ციფერბლათი შესაბამის დაუთოების ტემპერატურაზე დააყენეთ მის სათანადო ტემპერატურაზე მითითების საშუალებით.

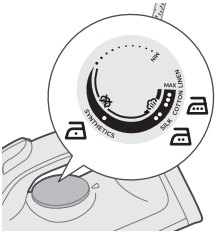

3 გააჩერეთ უთოს მის ფეხზე.

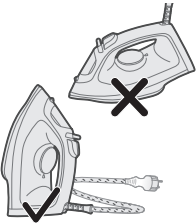

4 შეაერთეთ მონყობილობა კედლის დამინებულ როზეტში.

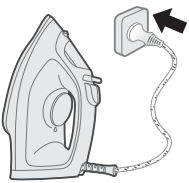

5 უთოს მზაობის ნათურა აინთება, რაც მიუთითებს, რომ უთო ცხელდება.

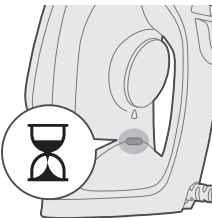

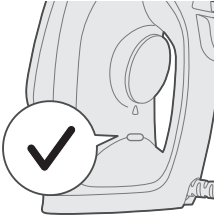

- როდესაც უთოს მზაობის ნათურა ჩაქრება, დაუთოების დაწყებამდე ცოტა ხანი დაიცადეთ. დაუთოებისას ნათურა დრო და დრო აინთება.

## ორთქლის გარეშე/მშრალი დაუთოება

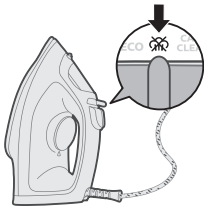

- დააყენეთ ორთქლის პარამეტრი ორთქლის გარეშე მაჩვენებელზე.

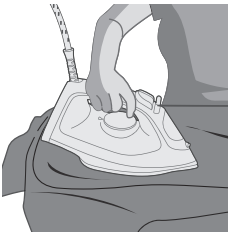

- გარკვეული დროის მერე, დაუთოების დროს ორთქლის მოწოდება შეწყდება.

## წყლის შესხურება

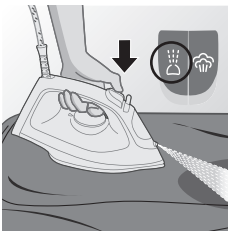

- დააყენეთ ორთქლის პარამეტრი ორთქლის გარეშე მაჩვენებელზე. დააწექით და აუშვით წყლის შესხურების ლილაკს წყლის ნაკადის გამოსაშვებად, რათა ჩამჯდარი ნაკეცები მოაშოროთ.

## ორთელის გაძლიერება

- 1 დააყენეთ ტემპერატურის ციფერბლატო მაქსიმალურ პარამეტრზე ბამბასა და ტილოს შორის.

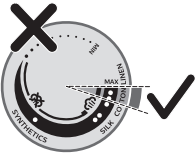

- 2 ჩამჭდარი ნაკეცების ძლიერი ორთელით გასასწორებლად თითო დააჭირეთ და აუშვით ორთელის მიწოდების გაძლიერების ღილაკს.



- 3 ორთელის მიწოდების გაძლიერების ფუნქციის გამოყენება ასევე შესაძლებელია უთოს ვერტიკალურ მდგომარეობაში დაჭერისას, ჩამოკიდებული ტანსაცმლიდან ნაკეცების მოსაშორებლად (მხოლოდ DST2020 და DST2030 მოდელებისთვის).

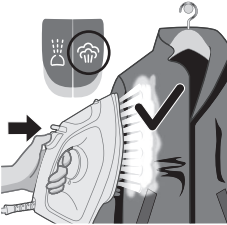

- 4 გამოქაჩეთ და გაჭიმეთ თქვენი ტანსაცმელი ორთელის მიწოდების გაძლიერების ფუნქციის გამოყენებისას ჩამჭდარი ნაკეცების მოსაშორებლად (მხოლოდ DST2020 და DST2030 მოდელებისთვის).

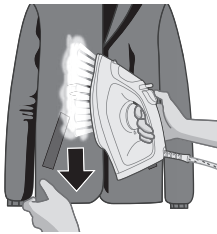

- 5 შიშველი ხელი არ გამოიყენოთ საყრდენ ზედაპირად, როდესაც იყენებთ ორთელს.



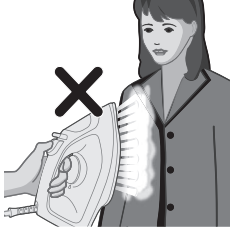

6 არ მიმართოთ მოწყობილობა თქვენკენ / სხვა პიროვნებისკენ.

## ავტომატური გამორთვის რეჟიმი (DST2030)

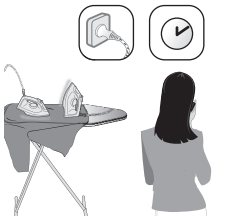

1 თქვენი სიმშვიდისთვის, მოწყობილობა თავისთავად გაცივდება, თუ მას გარკვეული პერიოდის განმავლობაში უყურადღებოდ დატოვებთ.

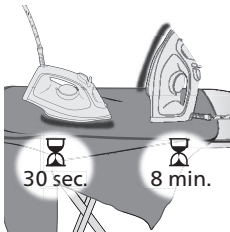

2 როდესაც მოწყობილობა არ გამოიყენება 30 წამზე მეტი ხნის განმავლობაში და დგას მის სადგამზე ან 8 წუთის განმავლობაში ფეხზე/ძირზე, იგი გადავა ავტომატური გამორთვის რეჟიმში.

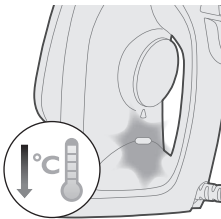

3 ავტომატური გამორთვის რეჟიმში მოწყობილობის ტემპერატურა შემცირდება. უთოს მზაობის ნათურა ასევე მუდმივად იციმციმებს, რაც მიუთითებს, რომ მოწყობილობა ავტომატური გამორთვის მდგომარეობაშია. მოწყობილობის სრულად გასათიშად, გამოაერთეთ მოწყობილობა შტეფსელიდან.

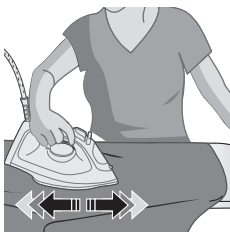

4 მოწყობილობის ხელახლა გასახურებლად აწიეთ ან გადაადგილეთ იგი.

## 630 ქართული ენა

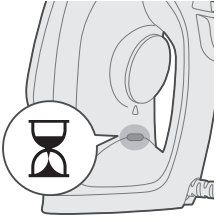

5 ორთქლის მზაობის ნათურა აინთება, რაც მიუთითებს, რომ მოწყობილობა ცხელდება.

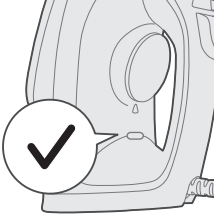

6 როგორც კი უთოს ნათურა გაითიშება, მოწყობილობა გამოსაყენებლად მზადაა.

## გასუფთავება და მოვლა-შენახვა

1 დაწინააღმდეგეთ, რომ მოწყობილობა არ არის შეერთებული.

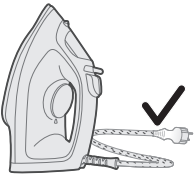
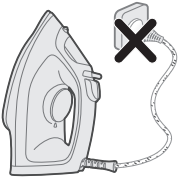

2 დაწინააღმდეგეთ, რომ მოწყობილობა გაგრილდა.

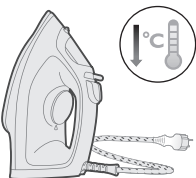

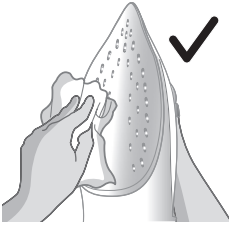

3 ძირიდან მოაცილეთ ფანტელები და სხვა სახის ნადები სველი ნაჭრით.



შენიშვნა: უთოს ძირის სიგლუვის შესანარჩუნებლად თავიდან აიცილეთ ლითონის საგნებთან შეხება. ძირის გასასუფთავებლად აკრძალულია სახეხი ღრუბლის, ძმრის ან სხვა ქიმიური ნივთიერების გამოყენება.



4 მოწყობილობა არ გარეცხოთ/განმინდოთ გამდინარე წყლით.

## ნადების მოშორება

რჩევა: ნადების სწრაფი მოშორების ფუნქციის გამოყენება ნებისმიერ დროს არის შესაძლებელი. თუ თქვენს რეგიონში ხისტი წყალია, გამოიყენეთ ფუნქცია უფრო ხშირად.



1 1 თვის გამოყენების შემდეგ, რეკომენდებულია ნადების მოშორება, მისი ექსპლუატაციის დროის გასახანგრძლივებლად და მოწყობილობის გაცხელების უზრუნველსაყოფად.

632 ქართული ენა

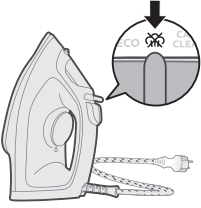

2 დარწმუნდით, რომ უთო გამორთულია და ორთქლის პარამეტრი დაყენებულია ორთქლის გარეშე მაჩვენებელზე (მშრალი დაუთოება) ~~წმ~~.

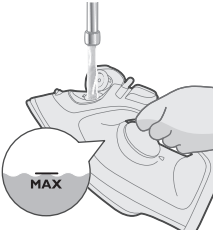

3 შეაყსეთ წყლის რეზერვუარი MAX ნიშნულამდე.



4 ტემპერატურის ციფერბლატი MAX ნიშნულზე დააყენეთ.

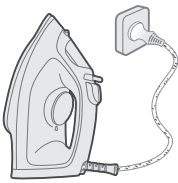

5 მოწყობილობა დამინებულ შტეფსელში შეაერთეთ.

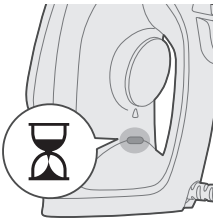

6 ორთქლის მზაობის ნათურა აინთება, რაც მიუთითებს, რომ მოწყობილობა ცხელდება.



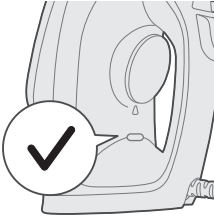

7 დაელოდეთ უთოს მზაობის ნათურის გათიშვას.

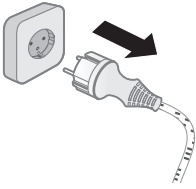

8 უთო შტეფსელიდან გამოაერთეთ.

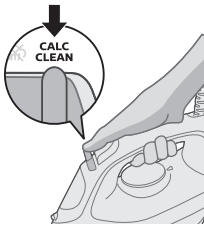

9 ორთქლის კონტროლური ნაღებისგან გაწმენდის მდგომარეობაში დააყენეთ და გააჩერეთ.



10 უთო ნიჟარის თავზე დაიჭირეთ და ნაზად შეანჯღრიეთ. უთოს ძირიდან ცხელი წყალი და ნაღების ნაწილაკები გამოვა.

გაფრთხილება: ნაღების გამორეცხვისას უთოს ძირიდან ასევე შეიძლება გამოვიდეს ორთქლი და მღუღარე წყალი.

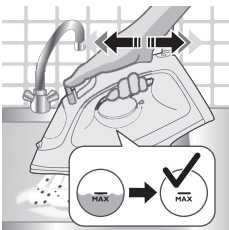

11 მანამდე ანჯღრიეთ უთო, სანამ წყლის რეზერვუარი წყლისგან სრულად არ დაიცლება.

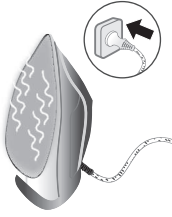

12 ჩართეთ მოწყობილობა ელექტროქსელში და დაელოდეთ ძირის გაშრობას. ამას დასჭირდება დაახლოებით 2 წუთი.

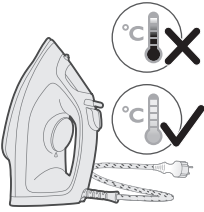

13 დააცადეთ, რომ უთო გაგრილდეს.

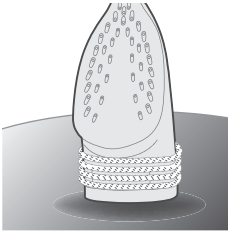

14 კაბელი უთოს ფეხს შემოახვიეთ.

## შენახვა

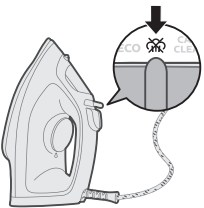

1 ორთქლის მაჩვენებელი ორთქლის გარეშე პარამეტრზე დააყენეთ (მშრალი დაუთოება) ~~წილ~~.

2 გამორთეთ მოწყობილობა ქსელიდან.

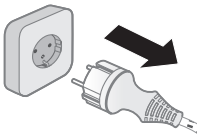

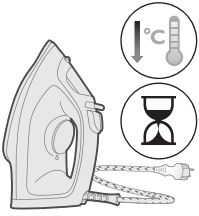

3 დაელოდეთ მოწყობილობის გაგრილებას.

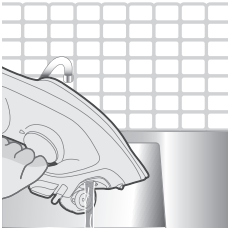

4 წყლის რეზერვუარიდან გადააქციეთ დარჩენილი წყალი.

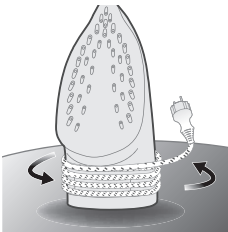

5 კაბელი მოწყობილობის ძირითად კორპუსს შემოახვიეთ.

## პრობლემის აღმოფხვრა

ამ თავში შეჯამებულია ყველაზე გავრცელებული პრობლემები, რომლებსაც მოწყობილობის გამოყენებისას შეიძლება შეხვდეთ. თუ პრობლემას ვერ აგვარებთ ქვემოთ მოცემული ინფორმაციით, ეწვიეთ გვერდს [www.philips.com/support](http://www.philips.com/support) ხშირად დასმული კითხვების სისთვის ან დაუკავშირდით მომხმარებელზე ზრუნვის ცენტრს თქვენს ქვეყანაში.

პრობლემა	შესაძლო მიზეზი	გადაწყვეტა
უთო ვერ ასწორებს ნაოჭებს ტანსაცმელზე.	დაუთოების დროს ორთქლი არ გამოიყოფა.	შეავსეთ წყლის რეზერვუარი და დააყენეთ ორთქლის გადამრთველი <b>☑</b> -ზე.
უთო არ გამოსცემს ორთქლს.	რეზერვუარში საკმარისი რაოდენობის წყალი არ არის.	შეავსეთ წყლის რეზერვუარი.
	ორთქლის გადამრთველი დაყენებულია <b>☒</b> -ზე.	ორთქლის გადამრთველი დააყენეთ <b>☑</b> -ზე.

	<p>უთო ჯერ არ არის საკმარისად ცხელი ორთქლის წარმოსაქმნელად.</p>	<p>უთოს გაცხელების დროს, „უთოს მზაობის“ ნათურა მუდმივად ანათებს. როცა უთო მზად იქნება გამოყენებისთვის, ნათურა გამოირთვება.</p>
<p>დაუთოების დროს ქსოვილზე ხვდება წყლის წვეთები.</p>	<p>მოკლე პერიოდის განმავლობაში ზედმეტად ხშირად გამოიყენეთ ორთქლის მიწოდების გაძლიერების ფუნქცია.</p>	<p>განაგრძეთ დაუთოება ჰორიზონტალურ მდგომარეობაში და ორთქლის გაძლიერების ფუნქციის ხელახალ გამოყენებამდე ცოტა ხანი მოიცადეთ.</p>
	<p>წყლის რეზერვუარის სახურავი არ არის დახურული.</p>	<p>დააჭირეთ სახურავს, სანამ ჩხაკუნს არ გაიგონებთ.</p>
<p>უთო არ გამოსცემს ძლიერ ორთქლს.</p>	<p>მოკლე პერიოდის განმავლობაში ზედმეტად ხშირად გამოიყენეთ ორთქლის გაძლიერების ფუნქცია.</p>	<p>განაგრძეთ დაუთოება ჰორიზონტალურ მდგომარეობაში და ორთქლის გაძლიერების ფუნქციის ხელახალ გამოყენებამდე ცოტა ხანი მოიცადეთ.</p>
	<p>უთო ჯერ არ არის საკმარისად ცხელი გასაუთოვებლად.</p>	<p>დაელოდეთ სანამ „უთოს მზაობის“ ინდიკატორი შეწყვეტს ციმციმს და სტაბილურად გაანათებს.</p>
	<p>წყლის რეზერვუარში არის ქიმიური ნივთიერება.</p>	<p>გარეცხეთ წყლის რეზერვუარი და არ დაამატოთ სუნამო ან ქიმიური ნივთიერება.</p>
<p>უთოს ქსელიდან გამორთვის შემდეგ ძირიდან წყალი წვეთავს.</p>	<p>ორთქლის გადამრთველი დაყენებულია <b>წმ-ზე</b>.</p>	<p>ორთქლის გადამრთველი დააყენეთ <b>წმ-ზე</b>.</p>

უთო შენახულ იქნა  
ჰორიზონტალურ  
მდგომარეობაში მაშინ, როცა  
რეზერვუარში ჯერ კიდევ წყალი  
იყო დარჩენილი.

დაცალეთ წყლის რეზერვუარი  
გამოყენების შემდეგ, ან  
შეინახეთ უთო ვერტიკალურ  
მდგომარეობაში.

უთოს გამოყენების შემდეგ  
ქსოვილზე კვალი ან ბრჭყვიალა  
შეფერილობა რჩება.

დასაუთოებელი ზედაპირი  
არათანაბარი იყო, მაგალითად,  
ქსოვილის ნაკერის ან ნაკეცის  
დაუთოვებისას.

უთოს გამოყენება  
შესაძლებელია ნებისმიერი  
ტიპის ქსოვის დაუთოებისთვის.  
სიპრიალე ან კვალი არ  
დარჩება მუდმივად და გაქრება  
ტანსაცმლის გარეცხვისას.  
მოერიდეთ დაუთოებას  
ნაკერებზე ან ნაკეცებზე.  
ტანსაცმელზე კვალის  
დატოვების თავიდან  
ასაცილებლად, ასევე  
შეგიძლიათ მოათავსოთ ბამბის  
ქსოვილი იმ ადგილას, სადაც  
საჭიროა დაუთოება.

## 产品简介

欢迎购买并使用飞利浦产品！为了让您能充分享受飞利浦提供的支持，请在 [www.philips.com/welcome](http://www.philips.com/welcome) 上注册您的产品。使用本产品前，请认真阅读本用户手册、重要信息手册和快速入门指南。请妥善保管这些文件，以供日后参考。

## 产品概述

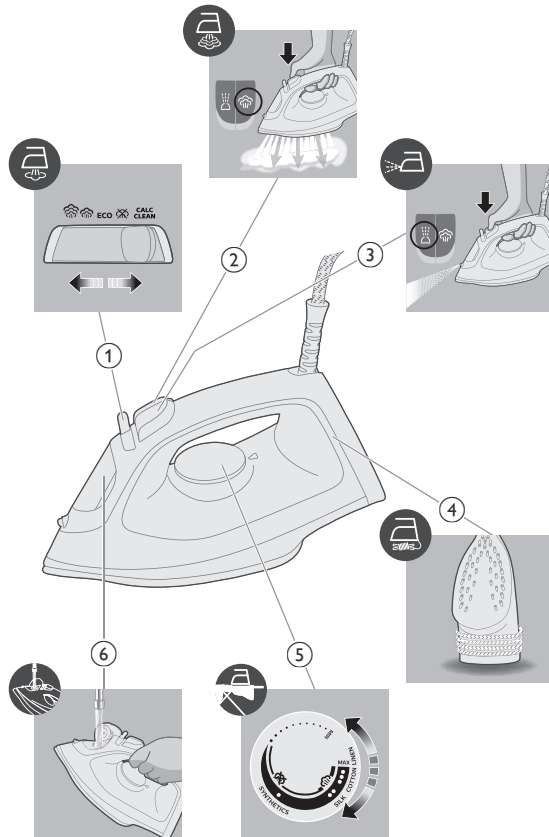

- 1 蒸汽选择器
- 2 蒸汽束喷射按钮
- 3 喷雾按钮
- 4 绕线装置
- 5 温度旋钮
- 6 水箱盖

## 使用本产品

### 使用准备

注意：首次使用熨斗时可能会出现一些蒸汽。此现象会在片刻后消失。

#### 所用水质类型

本产品可使用自来水。但如果您居住的区域水质较硬，我们建议您将等量的自来水与蒸馏水或软化水混合使用。这样可以防止水垢快速积聚，从而延长产品的使用寿命。

请勿将香水、转筒式干燥机中的水、醋、淀粉、除垢剂、熨衣剂、化学除垢水或其他化学品加入水箱，因为它们可能会导致喷水、留下褐色污垢或损坏产品。

### 给水箱注水

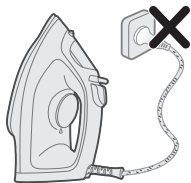

- 1 确保产品电源插头已拔下。

2 确保产品已冷却。

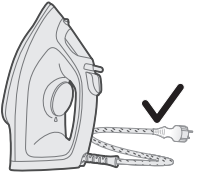

3 向右滑动蒸汽选择器，选择无蒸汽模式（干烫）☹️。

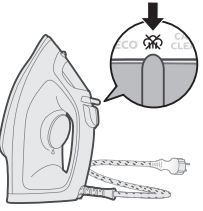

4 翻开水箱盖。

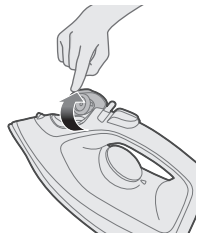

5 将水注入水箱，直至达到最高 (MAX) 水位标识。

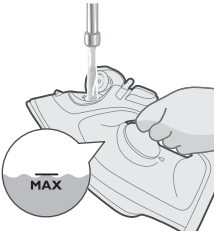

6 盖紧水箱盖。

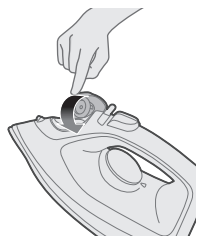



## 设定温度

		
	MAX 亚麻	
	●●● 棉质	
	●● 丝质	<b>ECO</b>
	● 化纤	



ECO 环保模式：用于褶皱较少的衣物，稳定提供最小持续蒸汽。此模式还可节能。



中等蒸汽模式：用于难以消除的褶皱，稳定提供较大持续蒸汽。



强蒸汽模式：用于顽固褶皱，稳定提供最大持续蒸汽。

## 使用本产品

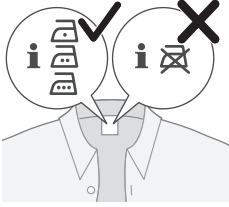

1 检查衣物是否可以熨烫。

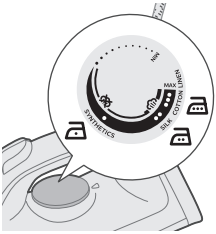

2 转动温度旋钮至合适的温度指示，以将其设定到所需的熨烫温度。

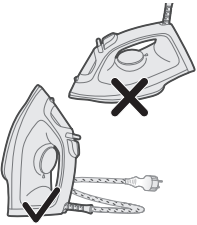

3 将熨斗竖立放置。

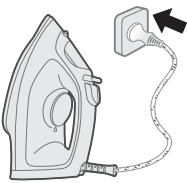

4 将产品电源线插入接地电源插座。

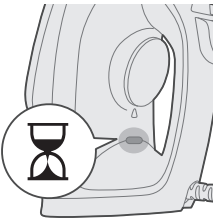

5 熨斗就绪指示灯将亮起，这表示熨斗正在加热。

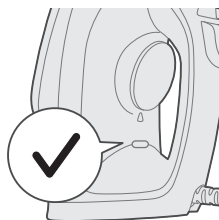

- 熨斗就绪指示灯熄灭后，请等待片刻，再开始进行熨烫。  
熨烫过程中，就绪指示灯将会不时亮起。

## 无蒸汽/干烫

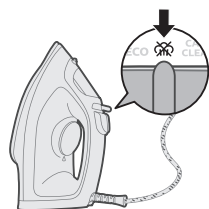

- 将蒸汽模式设置为无蒸汽模式。

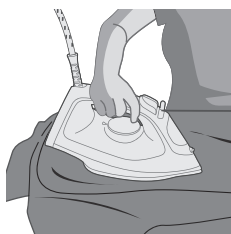

- 片刻过后，熨烫过程中蒸汽将会消失。

## 喷雾按钮



- 将蒸汽模式设置为无蒸汽模式。按下并松开喷雾按钮<sup>☼</sup>，即可喷出水雾，以去除顽固褶皱。

## 蒸汽束喷射

- 1 将温度旋钮调至棉和亚麻之间的 MAX（最大）设置。

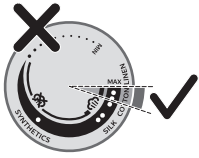

- 2 按下并松开蒸汽束喷射按钮，即可喷出强劲蒸汽，以去除顽固褶皱。

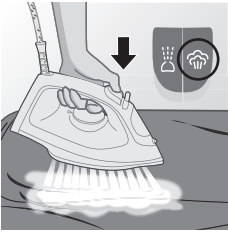

- 3 将熨斗竖起来时，您可以使用蒸汽束喷射功能，去除悬挂衣物上的褶皱（仅限 DST2020 和 DST2030）。

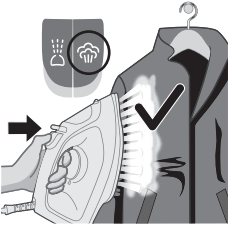

- 4 使用蒸汽束喷射的同时拉伸衣物，可去除顽固褶皱（仅限 DST2020 和 DST2030）。

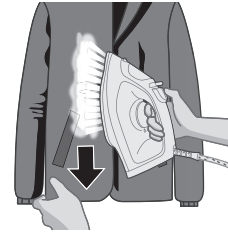

- 5 熨烫时请不要用手作为支撑面。



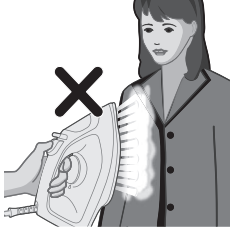

6 切勿将产品朝向自己/他人。

## 自动关熄功能 (DST2030)



1 为了让您高枕无忧，产品如果一段时间内处于无人看管状态，将会自行冷却。

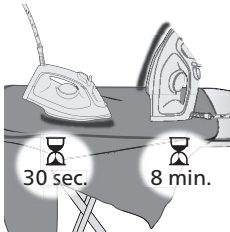
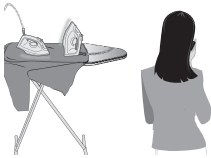

2 当产品底板向下放置超过 30 秒或竖立放置超过 8 分钟不使用时，设备将进入自动关熄模式。

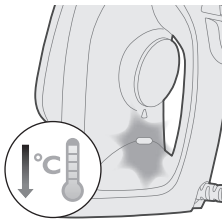

3 在自动关熄模式下，产品温度将会降低。熨斗就绪指示灯还会不停闪烁，以表示产品处于自动关熄状态。要完全关闭产品，请将其电源插头从插座上拔下。

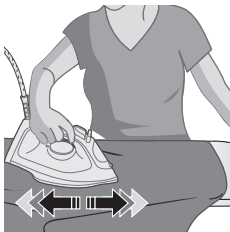

4 要让产品再次加热，请将产品拿起或稍微移动。

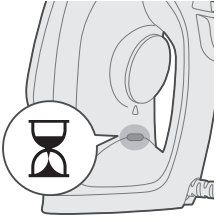

5 熨斗就绪指示灯将亮起，这表示产品正在加热。

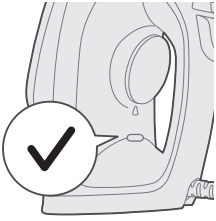

6 熨斗就绪指示灯关闭后，产品即可使用。

## 清洁和保养

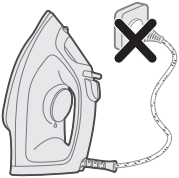

1 确保产品电源插头没有插上。

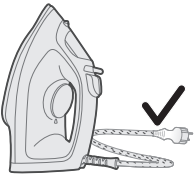

2 确保产品已冷却。

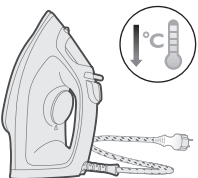

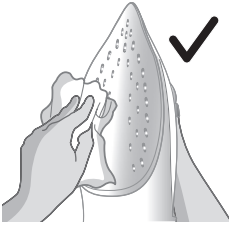

- 3 用湿布擦拭底板上的水垢和其他沉积物。

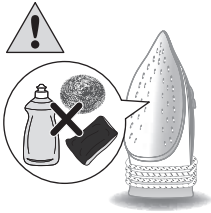

注意：为了保持底板光滑，请避免与金属物体发生硬接触。切勿使用钢丝绒、醋或其他化学品清洗底板。



- 4 请勿在自来水下清洗产品。

## 自动除垢功能

提示：快速除垢功能可以随时使用。如果您居住的区域水质较硬，请更频繁地使用该功能。



- 1 使用 1 个月后，建议使用自动除垢功能以去除产品中积聚的水垢，从而延长产品使用寿命并确保其加热效果。

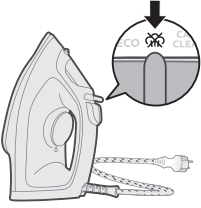

2 确保熨斗电源插头已拔下，蒸汽模式设置为无蒸汽模式（干烫）。

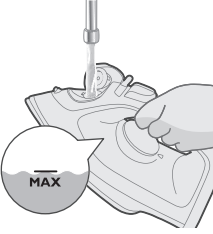

3 将水注入水箱，直至达到最高 (MAX) 水位标识。



4 将温度旋钮调至 MAX（最大）。

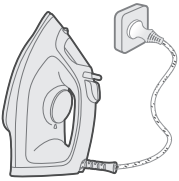

5 将产品电源线插入接地电源插座。

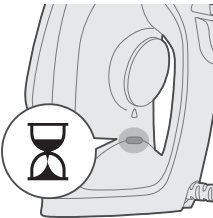

6 熨斗就绪指示灯将亮起，这表示产品正在加热。



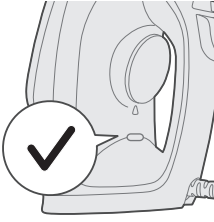

7 等待熨斗就绪指示灯熄灭。

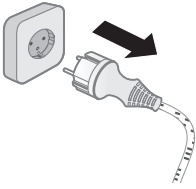

8 拔下熨斗插头。

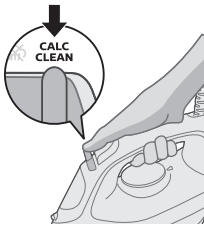

9 将蒸汽选择器滑动至自动除垢模式并保持不动。



10 在水槽上方轻轻摇动熨斗。热水和水垢颗粒将从底板排出。

小心：水垢冲出时，底板上也会冒出蒸汽和沸水。

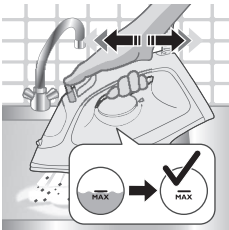

11 继续摇动熨斗，直到水箱中的水全部排完为止。

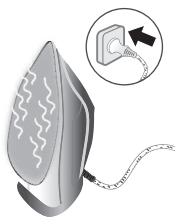

12 插上产品电源插头，加热产品以使底板干燥。这需要 2 分钟左右时间。

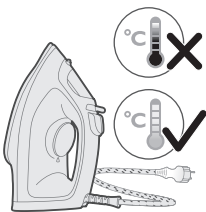

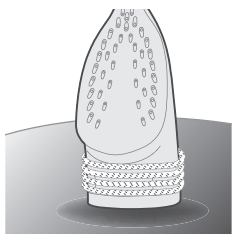

13 让熨斗自然冷却。

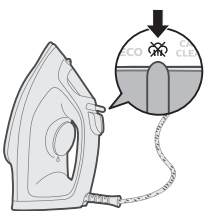

14 将电线缠绕在熨斗的底部。

## 存储



1 滑动蒸汽选择器以选择无蒸汽模式（干烫）.

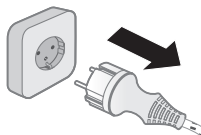

2 拔下本产品的插头。

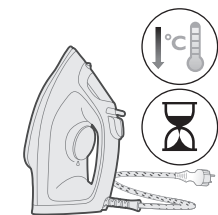

3 让产品自然冷却。

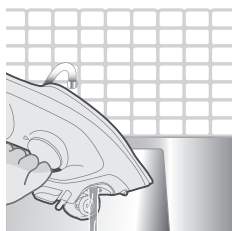

4 将水箱中剩余的水倒出。

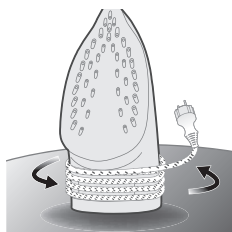

5 将电源线缠绕在产品机身上。

## 故障排除

本章归纳了您在使用本产品时常常遇到的问题。如果您无法根据以下信息解决问题，请访问 [www.philips.com/support](http://www.philips.com/support) 查阅常见问题列表，或联系您所在国家/地区的客户服务中心。

问题	可能的原因	解决方法
熨斗无法去除衣物上的褶皱。	熨烫时没有蒸汽。	为水箱加水并将蒸汽滑钮设置为 ☺。
熨斗没有蒸汽。	水箱中水不足。	为水箱加水。
	蒸汽滑钮已设置为 ☹。	将蒸汽滑钮设置为 ☺。
	熨斗温度尚不够高，无法产生蒸汽。	当熨斗加热时，“熨斗就绪”指示灯将常亮。当熨斗可供使用时，指示灯将关闭。

在熨烫过程中有水滴滴落到衣物上。	您在短时间内过于频繁地使用了蒸汽束喷射功能。	持续按水平方向熨烫，稍等片刻后再使用蒸汽喷射功能。
	您没有正确关闭水箱盖。	按下盖子，直到听到“咔哒”一声。
熨斗不产生蒸汽束。	您在短时间内过于频繁地使用了蒸汽束喷射功能。	持续按水平方向熨烫，稍等片刻后再使用蒸汽喷射功能。
	熨斗还不够热，无法进行熨烫。	等待“熨斗就绪”指示灯停止闪烁并进入常亮状态。
	您在水箱中放入了化学物质。	冲洗水箱，切勿将任何香水或化学物质放入水箱。
拔下熨斗后，底板有水滴落。	蒸汽滑钮已设置为  。	将蒸汽滑钮设置为  。
	您将熨斗水平放置，且水箱里还有水。	使用后应倒空水箱，或将熨斗垂直放置。
熨斗在衣物上留下亮斑或印痕。	熨烫表面不平坦，例如，因为您在衣物缝合或折叠处进行熨烫。	熨斗安全适用于各种可熨烫衣物。亮斑或印痕不会持久存在，清洗衣物后便可消失。避免熨烫缝合或折叠处。您可以在熨烫区域上放一块棉布，以免产生印痕。

# 簡介

感謝您購買本產品。歡迎來到飛利浦的世界！請至 [www.philips.com/welcome](http://www.philips.com/welcome) 註冊您的產品，以獲得飛利浦提供的完整支援。使用本產品前，請先詳閱本使用手冊、重要資訊手冊及快速入門指南。請妥善保存，以供日後參考。

# 產品概覽

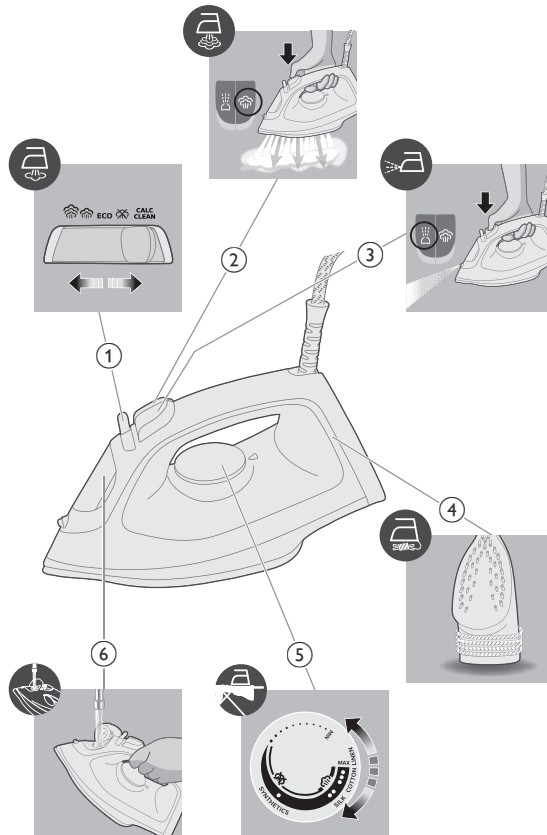

- 1 蒸氣控制鈕
- 2 強力蒸氣按鈕
- 3 水噴霧
- 4 捲線裝置
- 5 溫度控制轉鈕
- 6 水箱蓋

## 使用產品

### 使用前準備

備註：第一次使用時，熨斗可能會產生一些蒸氣。一下子就會停止。

#### 使用的水質

本產品適合搭配自來水使用。不過，如果您居住地區的水質偏硬，建議您將等量的自來水與蒸餾水或軟化水混合。如此可避免快速累積水垢，並延長產品的使用壽命。

請勿加入香水、滾筒式烘乾機的水、醋、燙衣漿、除垢劑、熨燙添加劑、經化學除垢的水或其他化學物質，否則可能造成水噴濺溢漏、產生棕色污漬或損壞產品。

### 加水至水箱內

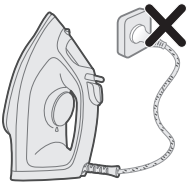

- 1 請勿將產品插上電源。

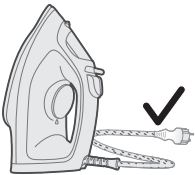

- 2 請確認產品已經冷卻。

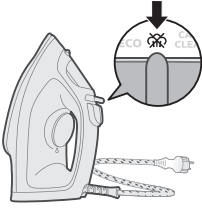

3 將蒸氣控制鈕向右滑動，即可選擇無蒸氣模式 (乾式熨燙) 。

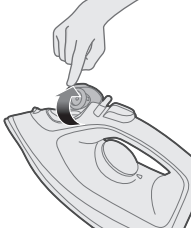

4 掀開水箱蓋。

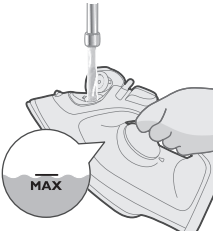

5 將水倒入水箱至 MAX 刻度。



6 確實蓋好水箱蓋。

## 設定溫度



MAX (最大)  
LINEN (亞麻)



● ● ●  
COTTON (棉)





SILK (絲)

ECO



SYNTHETICS (合成纖維)



ECO



ECO 設定：持續提供最小連續蒸氣，以撫平較少皺摺的衣物。此設定也可節省電力。



兩朵蒸氣雲：持續提供更多連續蒸氣，以撫平較難處理的皺摺。

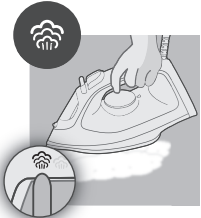

三朵蒸氣雲：持續提供最大連續蒸氣，以撫平頑強的皺摺。

## 使用產品

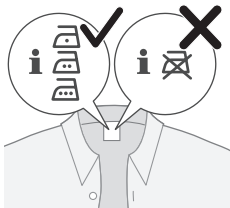

- 1 檢查衣物標籤，確認適用的熨燙方式。



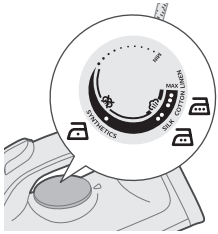

2 將溫度控制轉鈕轉到適當的溫度指示，以設定所需的熨燙溫度。

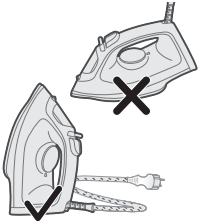

3 將熨斗直立放置。

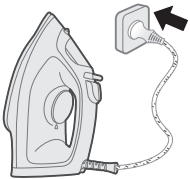

4 將產品插入接地的電源插座。

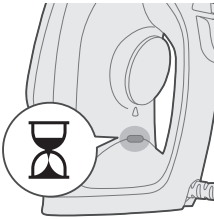

5 熨斗就緒指示燈會亮起，表示熨斗正在加熱。

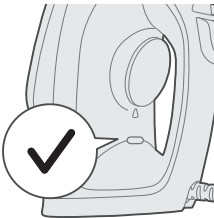

6 熨斗就緒指示燈熄滅時，請先稍待一會兒再開始熨燙。熨燙期間，就緒指示燈會不時亮起。

## 無蒸氣/乾式熨燙

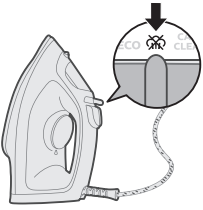

- 1 將蒸氣設定調整為無蒸氣。

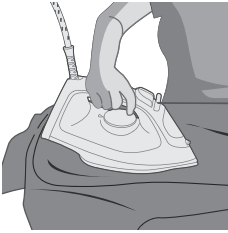

- 2 一段時間後，蒸氣會在熨燙期間停止。

## 水噴霧

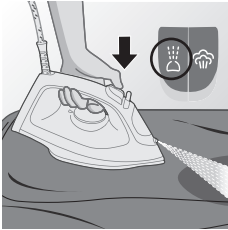

- 1 將蒸氣設定調整為無蒸氣。按下再放開水噴霧按鈕<sup>☼</sup>，即可噴出噴霧以撫平頑強的皺摺。

## 強力蒸氣

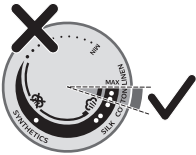

- 1 將溫度控制轉鈕調到棉與亞麻之間的 MAX 設定。

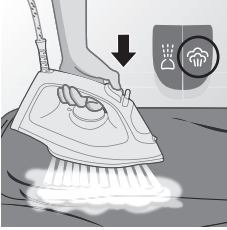

- 2 按下並放開強力蒸氣按鈕，便會噴射出強力蒸氣，可熨平衣物上的頑強皺摺。

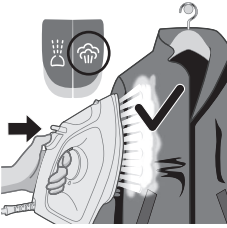

- 3 垂直握住熨斗時，也可以使用強力蒸氣功能，熨平吊掛衣物上的皺摺 (僅適用於 DST2020 和 DST2030)。

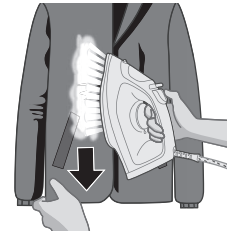

- 4 使用強力蒸氣熨燙時，可拉直衣物，有助於撫平頑強皺摺 (僅適用於 DST2020 和 DST2030)。



- 5 熨燙時，請勿直接以未受保護的手作為支撐平面。

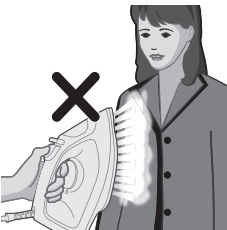

- 6 請勿將產品朝向自己/他人。

## 自動斷電 (DST2030)

- 1 產品如有一段時間沒有使用，將會自行冷卻，請放心。

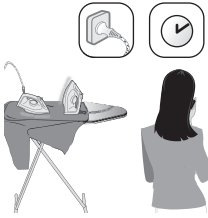

- 2 當產品在底盤上休息超過 30 秒鐘，或直立放置超過 8 分鐘時，產品將進入自動斷電模式。

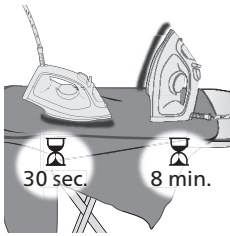

- 3 在自動斷電模式下，產品的溫度會下降。熨斗就緒指示燈也會持續閃爍，表示產品處於自動斷電狀態。若要完全關閉產品電源，請將產品的插頭從插座拔下。

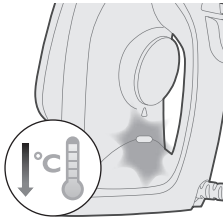

- 4 若要讓產品再次加熱，只要拿起產品或稍微移動即可。

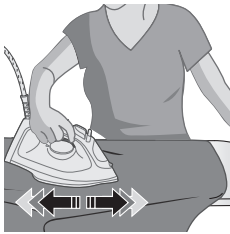

- 5 熨斗就緒指示燈會亮起，表示產品正在加熱。

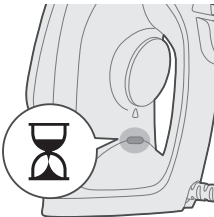

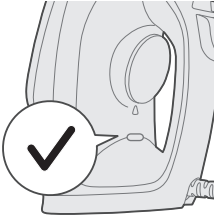

- 6 熨斗就緒指示燈熄滅後，即可開始使用產品。

## 清潔與維護

- 1 請確認產品未插電。

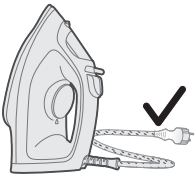
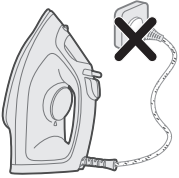

- 2 請確認產品已經冷卻。

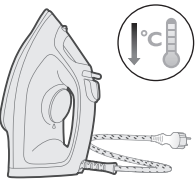

- 3 用濕布擦掉底盤的小薄片和其他沈積物。

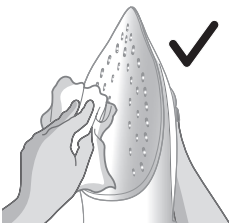



備註：為保持底盤平滑，請避免底盤撞擊金屬物體。切勿使用鋼絲絨、醋或其他的化學物質來清洗底盤。

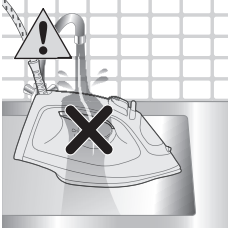

4 請勿在流動的水中清洗/清潔本產品。

## 除鈣清洗



提示：您可以隨時使用快速除鈣功能。如果您居住的區域水質較硬，請更頻繁地使用此功能。

1 使用 1 個月後，建議您執行除鈣清洗，去除產品累積的鈣垢，以延長產品的使用壽命，並確保產品加熱效果。

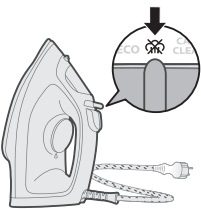

2 請確認產品並未插電，且蒸氣設定在無蒸氣模式 (乾式熨燙) 。



3 將水倒入水箱至 MAX 刻度。



4 將溫度控制轉鈕設定到 MAX。

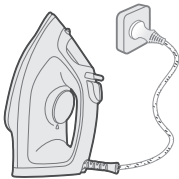

5 將產品插入接地插座。

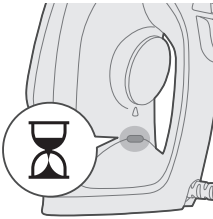

6 熨斗就緒指示燈會亮起，表示產品正在加熱。

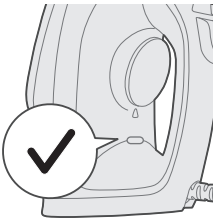

7 請等待熨斗就緒指示燈熄滅。

8 拔下熨斗插頭。

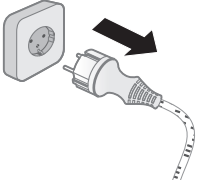

9 把蒸氣控制鈕推到除鈣清洗功能位置，並且按住不放。

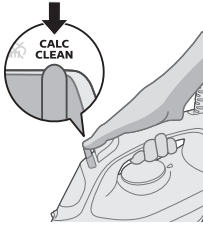

10 將熨斗拿到水槽上方，輕輕搖晃熨斗。熱水和鈣垢雜質會從底盤流出。

警告：水垢被沖出來時，蒸氣和滾水也會從底盤流出。



11 輕輕搖動熨斗，直到水箱的水全都流盡。

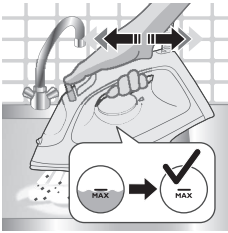

12 插上產品插頭，讓其加熱，讓底盤變乾。這大約需要 2 分鐘。





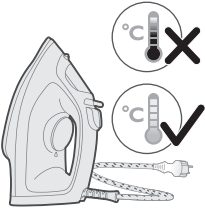

13 讓熨斗冷卻。

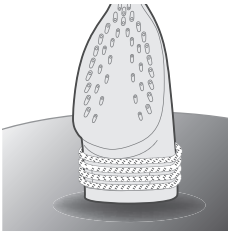

14 將電線纏繞在熨斗底部。

## 收納

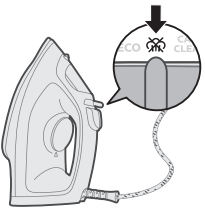

1 滑動蒸氣控制鈕，選擇無蒸氣模式 (乾式熨燙) .

2 將產品插頭拔除。

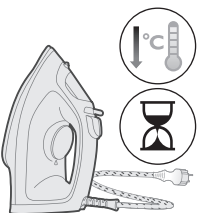
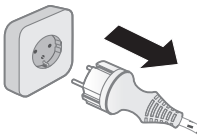

3 先讓產品冷卻。

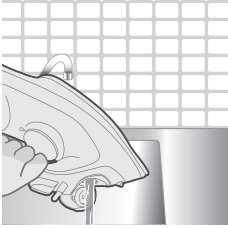

4 將水箱中剩餘的水倒空。

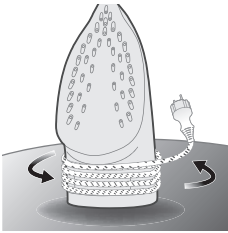

5 將電線纏繞在產品主體。

## 疑難排解

本單元概述您使用本產品時可能遇到的最常見問題。如果下方資訊無法解決您遇到的問題，請造訪 [www.philips.com/support](http://www.philips.com/support) 查看常見問題集清單，或聯絡您所在國家/地區的飛利浦客戶服務中心。

問題	可能原因	解決方案
熨斗無法燙平衣物的皺摺。	熨燙時沒有蒸氣。	加水至水箱，並將蒸氣撥鈕設定至  。
熨斗不會產生蒸氣。	水箱中的水量不足。	為水箱加水。
	將蒸氣撥鈕設定至  。	將蒸氣撥鈕設定至  。
	熨斗的溫度不足以產生蒸氣。	熨斗加熱時，「熨斗就緒」指示燈會持續亮起。熨斗準備就緒可供使用時，指示燈會熄滅。
熨燙時，水滴滴到衣料上。	您在短時間內使用太多次強力蒸氣功能。	請保持水平位置繼續熨燙，靜待一陣子之後，再使用強力蒸氣功能。
	您可能沒把水箱蓋蓋好。	按壓蓋子，直到聽到「喀噠」聲。
熨斗沒有產生強力蒸氣。	您在短時間內使用太多次強力蒸氣功能。	請保持水平位置繼續熨燙，靜待一陣子之後，再使用強力蒸氣功能。
	熨斗的溫度不足以進行熨燙。	請等待「熨斗就緒」指示燈停止閃爍且持續亮起。
	您在水箱中加入化學物質。	以水清洗水箱，不要將任何的香水或化學物質倒入水箱中。

熨斗插頭拔除後，底盤會滴水。

將蒸氣撥鈕設定至 。

將蒸氣撥鈕設定至 。

在水箱裡還有水時就將熨斗平放。

使用完畢後，請將水箱內的水清空，或以垂直方式收納熨斗。

熨斗在衣服上留下亮痕或燙印。

待熨燙的表面不平整，例如褶縫或折線。

熨斗可安全用於所有可熨燙的衣物。亮痕或燙印並非永久，會在衣物洗滌後消失。避免熨燙任何褶縫或折線。您也可以待熨燙的區域上放置一塊棉布，以避免留下燙印。

# 소개

필립스 제품을 구입해 주셔서 감사합니다! 필립스가 드리는 지원 혜택을 받으실 수 있도록 [www.philips.com/welcome](http://www.philips.com/welcome)에서 제품을 등록하십시오. 본 제품을 사용하기 전에 이 사용 설명서와 중요 정보 책자, 요약 설명서를 주의 깊게 읽으십시오. 나중에 참조할 수 있도록 이 설명서를 보관하십시오.

# 제품 개요

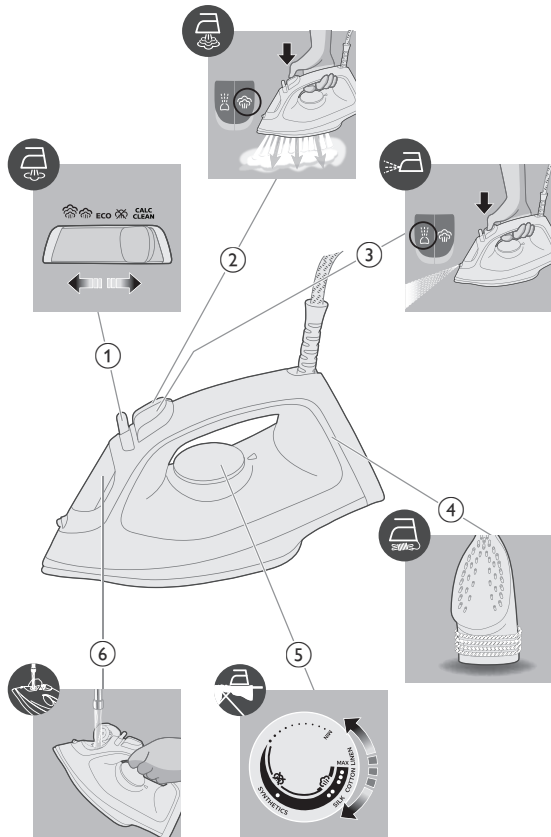

- 1 스팀 조절기
- 2 순간 스팀 버튼
- 3 물 스프레이
- 4 코드 감기
- 5 온도 조절기
- 6 물탱크 뚜껑

## 제품 사용하기

### 사용 준비

참고: 다리미를 처음 사용할 때는 스팀이 약간 나올 수 있습니다. 이는 잠시 후면 사라집니다.

#### 사용할 물의 종류

이 제품은 수도물을 사용하는 것이 적합합니다. 그러나 경수 지역에 거주하는 경우, 수도물과 같은 양의 증류수 또는 탈염수를 혼합하는 것이 좋습니다. 이로써 석회질이 빨리 쌓이지 않고, 제품의 수명이 연장됩니다.

**향수, 회전식 건조기의 물, 식초, 풀, 석회질 제거제, 다림질 보조제, 이물질 제거용 화학 약품이나 기타 화학 약품을 추가하지 마십시오. 물이 튀거나, 갈색 얼룩이 생기거나, 제품이 손상될 수 있습니다.**

### 물탱크 채우기

- 1 제품에 전원을 연결하지 마십시오.

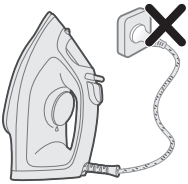

- 2 제품이 식었는지 확인하십시오.

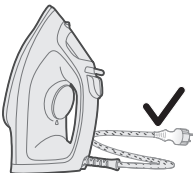

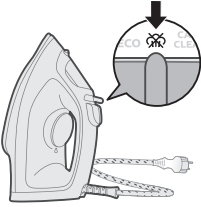

3 스팀 조절기를 오른쪽으로 밀어 스팀 없음 모드(건식 다림질)를 선택합니다.

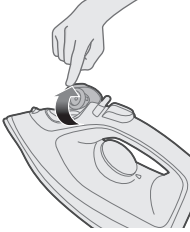

4 물탱크 뚜껑을 잠겨서 엽니다.

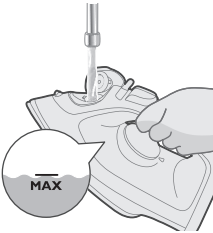

5 물탱크의 MAX 눈금까지 물을 채우십시오.



6 물탱크 뚜껑을 꼭 닫으십시오.

## 온도 조절



최대  
마



● ● ●  
면





실크

ECO



합성섬유



ECO



ECO 설정: 주름이 다소 적은 옷감에 이용할 경우 최소량의 스팀을 연속적으로 일정하게 분사합니다. 이 설정으로 에너지도 절약됩니다.



스팀 구름 2개: 잘 펴지지 않는 주름을 펴기 위해 더 많은 스팀을 연속적으로 일정하게 분사합니다.

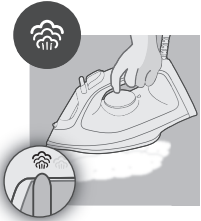

스팀 구름 3개: 심하게 구겨진 주름을 펴기 위해 최대량의 스팀을 연속적으로 일정하게 분사합니다.

## 제품 사용하기

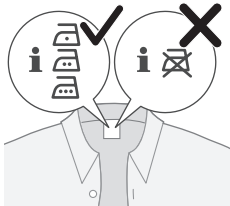

- 1 다림질은 의류에 부착된 세탁 표시를 참고하십시오.

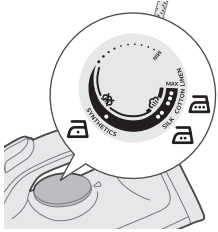

2 온도 조절 다이얼을 돌려서 적절한 다리질 온도에 맞추십시오.

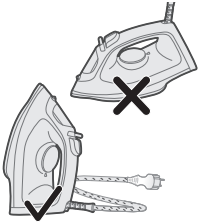

3 다리미를 세워 둡니다.

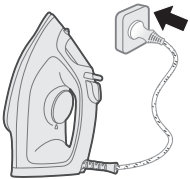

4 제품 플러그를 접지된 벽면 콘센트에 연결합니다.

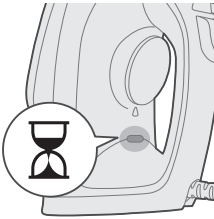

5 다리미가 가열되고 있음을 나타내는 다리질 준비 표시등이 켜집니다.

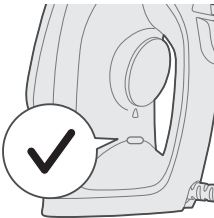

6 다리질 준비 표시등이 꺼지면, 잠시 기다린 후 다리질을 시작하십시오. 다리질하는 도중 준비 표시등이 수시로 켜집니다.



## 스팀 없음/건식 다리미질

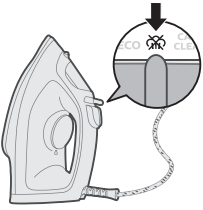

- 1 스팀 설정을 스팀 없음 설정으로 설정합니다.

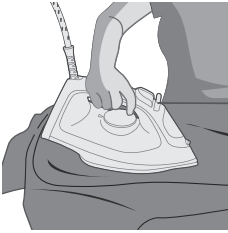

- 2 잠시 후 다리미질을 하는 동안 스팀이 중단됩니다.

## 물 스프레이

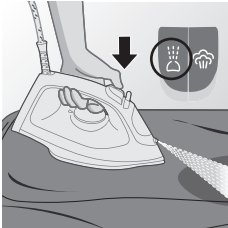

- 1 스팀 설정을 스팀 없음 설정으로 설정합니다. 물 스프레이 버튼을 눌렀다가 놓으면 물이 분사되어 심하게 구겨진 주름을 펴 수 있습니다.

## 순간 스팀

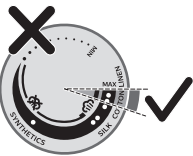

- 1 온도 다이얼을 면과 마 사이 MAX에 맞추십시오.

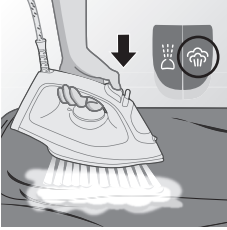

2 순간 스팀 버튼을 눌렀다가 놓으면 강력한 순간 스팀이 나와서 심하게 구겨진 주름을 제거할 수 있습니다.

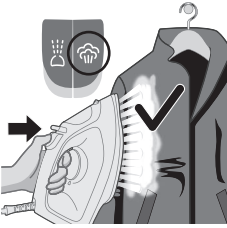

3 순간 스팀 기능은 걸려있는 의류의 주름을 없애기 위해 다리미를 수직으로 들고 있는 상태에서 사용할 수 있습니다(DST2020 및 DST2030만 해당).

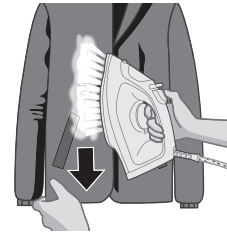

4 의류를 당겨 펴면서 순간 스팀을 사용하여 심하게 구겨진 주름을 펴십시오(DST2020 및 DST2030만 해당).



5 다리미를 사용할 때는 맨손을 지지대로 사용하지 마십시오.



6 제품을 자신 또는 다른 사람을 향해 놓지 마십시오.

## 자동 전원 차단(DST2030)

- 1 일정 시간 동안 제품을 사용하지 않으면 제품이 알아서 식어 안심하고 사용할 수 있습니다.

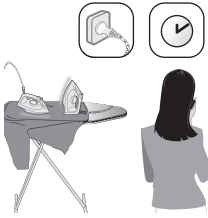

- 2 제품을 열판에 올려놓고 30초 이상 사용하지 않거나 세워둔 채 8분 이상 사용하지 않으면 제품이 자동 전원 차단 모드로 전환됩니다.

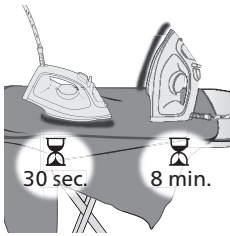

- 3 자동 전원 차단 모드에서는 제품 온도가 낮아집니다. 다림질 준비 표시등 또한 계속 깜박이며 제품이 자동 꺼짐 상태임을 나타냅니다. 제품을 완전히 고려면 제품의 전원 코드를 콘센트에서 뽑으십시오.

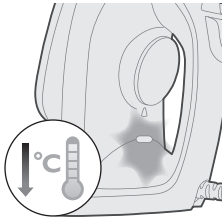

- 4 제품을 다시 가열하려면 제품을 든 채로 약간 움직이십시오.

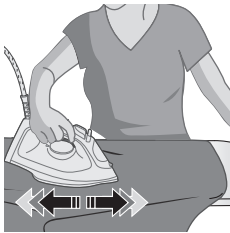

- 5 제품이 가열되고 있음을 나타내는 다림질 준비 표시등이 켜집니다.

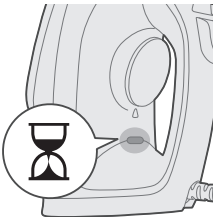

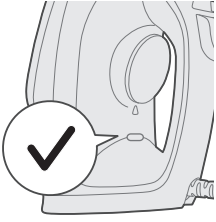

6 다림질 준비 표시등이 꺼지면 제품을 사용할 준비가 된 것입니다.

## 청소 및 유지관리

1 전원 플러그가 전원에 연결되지 않도록 합니다.

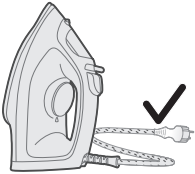
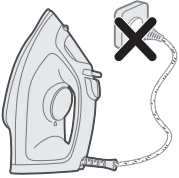

2 제품이 식었는지 확인하십시오.

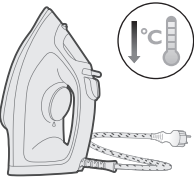

3 젖은 천으로 열판에 묻은 이물질질을 닦으십시오.





참고: 열판을 매끄럽게 유지하려면, 금속 물질에 긁히지 않도록 주의하십시오.  
열판을 닦을 때는 절대 수세미나 식초 또는 기타 화학 약품을 사용하지 마십시오.

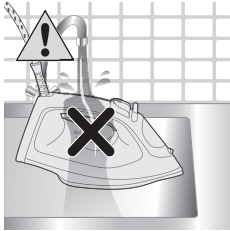

4 흐르는 물로 제품 전체를 헹구거나 세척하지 마십시오.

### 석회질 세척

도움말: 빠른 석회질 제거 기능은 언제든지 사용할 수 있습니다. 경수를 사용하는 지역에 살고 있는 경우에는 이 기능을 더 자주 사용하십시오.



1 제품의 수명을 연장하고 제품이 가열되도록 1개월 사용 후 석회질을 제거하는 것이 좋습니다.

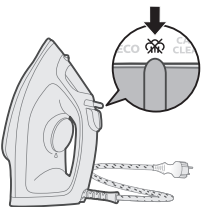

2 다리미의 전원 플러그가 분리되어 있고 스팀 설정이 스팀 없음 모드(건식 다리미질)에 맞추어져 있는지 확인하십시오.



3 물탱크의 MAX 표시선까지 물을 채우십시오.



4 온도 조절기를 MAX로 설정하십시오.

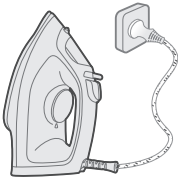

5 제품 플러그를 접지된 벽면 콘센트에 연결합니다.

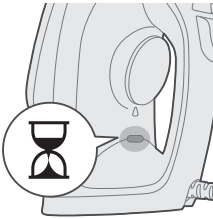

6 제품이 가열되고 있음을 나타내는 다림질 준비 표시등이 켜집니다.

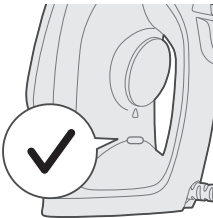

7 다림질 준비 표시등이 꺼질 때까지 기다리십시오.

8 다리미의 전원을 뽑으십시오.

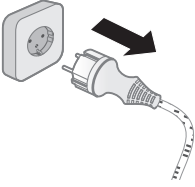

9 스팀 조절기를 석회질 제거 위치로 맞춥니다.

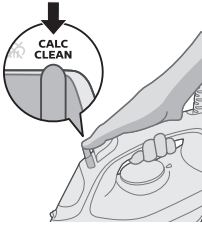

10 다리미를 싱크대 위에서 들고 가볍게 흔들어 주십시오. 열판에서 뜨거운 물과 석회질 입자가 나옵니다.



주의: 석회질이 씻겨져 나오는 동안 스팀과 끓는 물도 열판에서 새어나옵니다.

11 물탱크의 모든 물이 나올 때까지 다리미를 계속 흔들십시오.

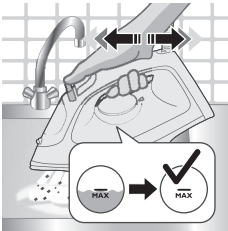

12 제품에 전원을 연결하고 열판이 마르도록 제품을 가열합니다. 이 과정은 약 2분이 걸립니다.

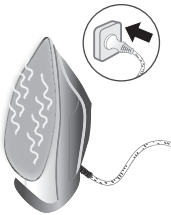

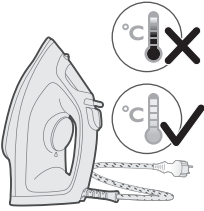

13 다리미를 식혀주십시오.

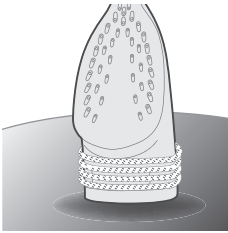

14 다리미 받침대 주위에 전원 코드를 감으십시오.

## 보관

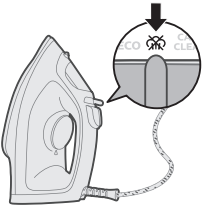

1 스팀 조절기를 밀어 스팀 없음 모드(건식 다리질)를 선택합니다.

2 제품의 전원 코드를 뽑습니다.

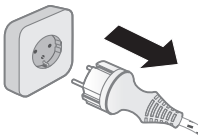

3 제품을 식혀주십시오.

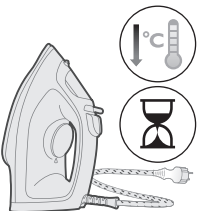



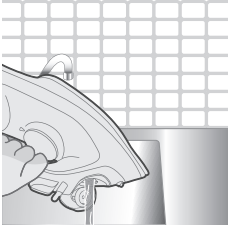

4 물탱크에 남아 있는 물을 모두 따라내십시오.

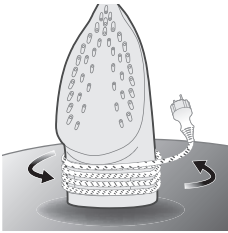



5 제품 본체 주위에 전원 코드를 감으십시오.

## 문제 해결

이 장은 제품을 사용하면서 일반적으로 경험하게 되는 문제와 그 해결 방법을 제시합니다. 아래의 정보로도 문제를 해결할 수 없는 경우 [www.philips.com/support](http://www.philips.com/support)를 방문하여 자주 묻는 질문(FAQ) 목록을 참조하거나 필립스 고객 상담실로 문의하십시오.

문제점	가능한 원인	해결책
다리미로 옷감의 주름이 없어지지 않습니다.	다리미질하는 동안 스팀이 나오지 않습니다.	물탱크에 물을 채우고 스팀량 조절기를  위치로 맞추십시오.
다리미에서 스팀이 나오지 않습니다.	탱크의 물이 충분하지 않습니다.	물탱크를 채우십시오.
	스팀량 조절기가  위치에 맞춰져 있습니다.	스팀량 조절기를  위치로 맞추십시오.
	다리미가 스팀이 나올 만큼 가열되지 않았습니다.	다리미가 가열되는 동안 "다리미질 준비" 표시등이 켜집니다. 다리미를 사용할 준비가 되면 표시등이 꺼집니다.
다리미질하는 동안 옷 위로 물방울이 떨어집니다.	순간 스팀 기능을 짧은 시간 동안 너무 자주 사용했습니다.	순간 스팀 기능을 다시 사용하기 전에 수평으로 다리미질을 하면서 조금만 기다리십시오.
	물탱크 뚜껑을 제대로 닫지 않았습니다.	'딸깍' 소리가 날 때까지 눌러 뚜껑을 닫아주십시오.
다리미에서 순간 스팀이 나오지 않습니다.	순간 스팀 기능을 짧은 시간 동안 너무 자주 사용할 수 있습니다.	순간 스팀 기능을 다시 사용하기 전에 수평으로 다리미질을 하면서 조금만 기다리십시오.

	다리미가 다림질할 만큼 뜨겁지 않습니다.	'다림질 준비' 표시등이 깜박임을 멈추고 계속 켜져 있을 때까지 기다리십시오.
	물탱크에 화학 물질을 넣었을 수 있습니다.	물탱크를 헹구고 물탱크에 향수나 화학 물질을 넣지 마십시오.
다리미 전원 코드를 뽑은 후에 열판에서 물이 떨어집니다.	스팀량 조절기가  위치에 맞춰져 있습니다.	스팀량 조절기를  위치로 맞추십시오.
	물탱크에 물이 아직 남아 있는 상태에서 다리미를 수평으로 놓으셨습니다.	사용 후에는 물탱크를 비우거나 다리미를 세워서 보관하십시오.
다림질 후에 옷감에 윤이나 자국이 남습니다.	옷의 솔기 또는 주름과 같이 다림질한 표면이 고르지 않은 것입니다.	이 다리미는 모든 다림질 가능한 옷감에 안전하게 사용할 수 있습니다. 윤이나 자국은 영구적인 것이 아니라 옷을 세탁하면 지워집니다. 솔기 또는 주름에 자국이 생기는 것을 방지하려면 솔기 또는 주름 부분은 다림질을 하지 않거나 다림질할 부위에 먼 소재의 천을 올려놓고 다림질을 하십시오.

## المقدمة

تهانينا على شرائك المنتج، ومرحبًا بك في Philips! للاستفادة بالكامل من الدعم الذي تقدمه Philips، سجّل منتجك على [www.philips.com/welcome](http://www.philips.com/welcome). اقرأ دليل المستخدم هنا وكتيّب المعلومات الهامة ودليل البدء السريع بدقة قبل استخدام الجهاز. واحتفظ بكل المستندات للرجوع إليها في المستقبل.

## نظرة عامة حول المنتج

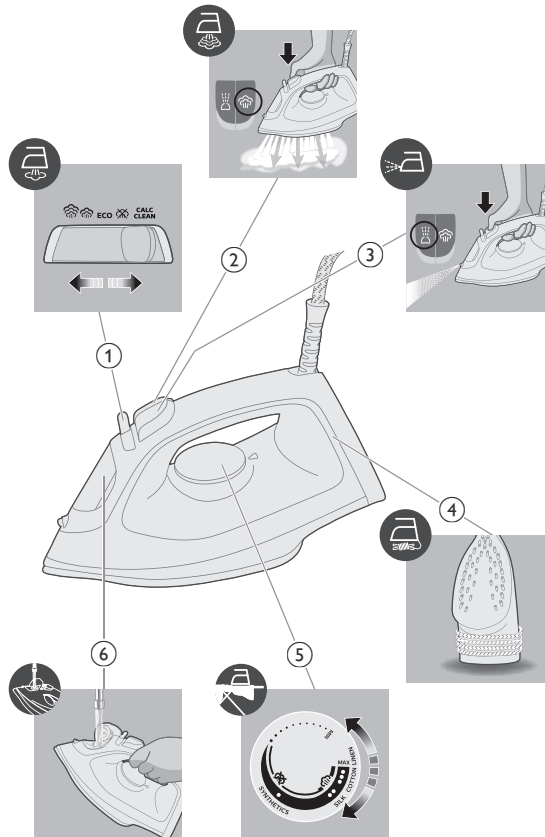

- 1 محدد البخار
- 2 زر تعزيز البخار
- 3 رنان الماء
- 4 تخزين السلك
- 5 مفتاح التحكم بدرجة الحرارة
- 6 غطاء خزان المياه

## استخدام الجهاز

### التحضير للاستخدام

ملاحظة: قد تصدر المكواة كمية قليلة من البخار عند استخدامها للمرة الأولى، لكن هذا الأمر سيتوقف بعد وقت قصير.

#### نوع المياه الذي يجب استخدامه

يعدّ الجهاز مناسبًا للاستخدام مع مياه الحنفية. ومع ذلك، إذا كنت تعيش في منطقة حيث تكون المياه عسرة، ننصحك بمزج كمية متساوية من مياه الحنفية مع مياه مقطرة أو تمت إزالة المعادن منها. سيمنع ذلك تراكم الترسبات الكلسية بسرعة ويطيل فترة استخدام الجهاز.

لا تستخدم المياه المعطرة أو مياه آلة تجفيف الملابس أو الخل أو النشاء أو مواد إزالة الكلس أو المواد المساعدة على الكي أو المياه التي تمت إزالة الكلس منها كيميائيًا أو غيرها من المواد الكيميائية، إن قد تتسبب بخروج المياه من المكواة أو ظهور بقع بنية أو بالحاق الضرر بالجهاز.

### تعبئة خزان المياه

- 1 لا تقم بتوصيل الجهاز.

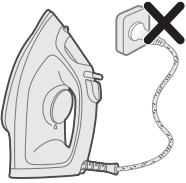

- 2 تأكد من أن الجهاز قد برد.

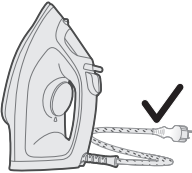

3 مَرَّ محدد البخار إلى اليمين لتحديد وضع "لا بخار" (الكي الجاف) 

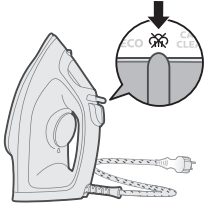

4 افتح غطاء خزان المياه.

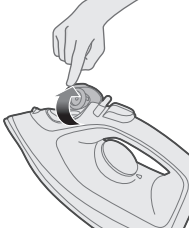

5 املاَ خزان المياه حتى مؤشر MAX (الحد الأقصى).

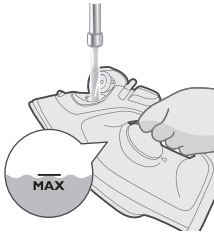

6 أغلق غطاء خزان المياه بإحكام.



## إعداد درجة الحرارة



العدد الأقصى  
كتان



● ● ●  
قطن



ECO



حرير

●  
صناعي

ECO



إعداد ECO: يتم إصدار أدنى حد من البخار المستمر بشكل متواصل للملابس التي تتضمن تجاعيد أقل. بالإضافة إلى ذلك، يوفر هذا الإعداد من استهلاك الطاقة.



سحابتا بخار: يتم إصدار المزيد من البخار المستمر بشكل متواصل للتجاعيد الصعبة.



ثلاث سحابات بخار: يتم إصدار أقصى حد من البخار المستمر بشكل متواصل للتجاعيد المستعصية.

## استخدام الجهاز

1 تحقق من ملصق الثياب للاطلاع على تعليمات الكي المطلوبة.

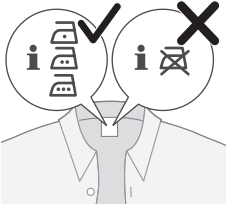

2 قم بتعيين قرص درجة الحرارة إلى درجة حرارة الكي المطلوبة عن طريق تدويره إلى مؤشر درجة الحرارة المناسب.

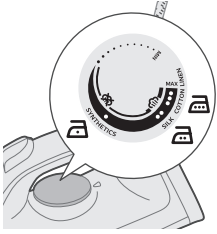

3 ضع المكواة على قاعدتها.

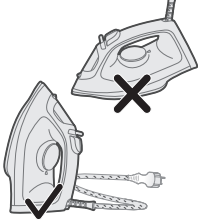

4 قم بتوصيل الجهاز بمقبس حائط مؤرّض.

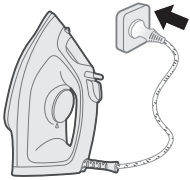

5 سيضيء الضوء الذي يشير إلى أن 'المكواة جاهزة' للإشارة إلى أن المكواة قيد الإحماء.

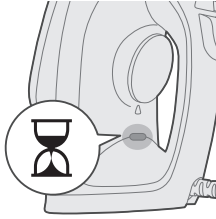

6 عندما ينطفئ الضوء الذي يشير إلى أن 'المكواة جاهزة'، انتظر قليلاً قبل أن تبدأ بالكي. سيضيء الضوء الذي يشير إلى أن 'المكواة جاهزة' من وقت إلى آخر في أثناء الكي.

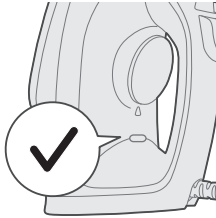

## لا بخار/الكي الجاف

1 قم بتعيين إعداد البخار إلى إعداد "لا بخار".

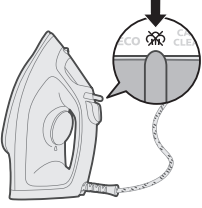

2 بعد فترة قصيرة، سيتوقف صدور البخار في أثناء الكي.

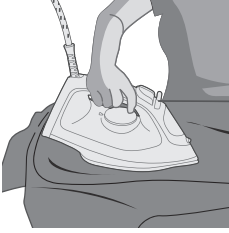

## رذاذ الماء

1 قم بتعيين إعداد البخار إلى إعداد "لا بخار". اضغط على زر رذاذ الماء وحرره للحصول على تدفق رذاذ مياه من أجل التخلص من التجاعيد المستعصية.

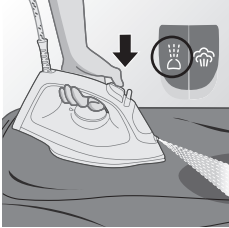

## تعزيز البخار

1 قم بتعيين قرص درجة الحرارة إلى إعداد الحد الأقصى بين القطن والكتان.

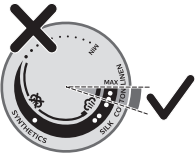



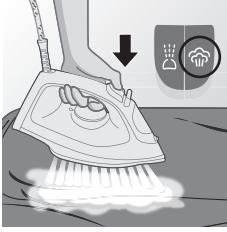

2 اضغط على زر تعزيز البخار وحرره للحصول على دفعة قوية من البخار من أجل التخلص من التجاعيد المستعصية.

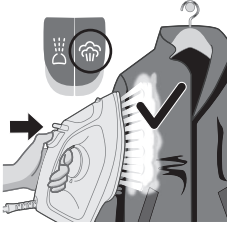

3 يمكنك استخدام وظيفة تعزيز البخار عندما تمسك بالمكواة بشكل عمودي للتخلص من التجاعيد عن الملابس المعلقة (لطرّازي DST2020 و DST2030 فقط).

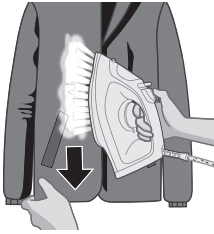

4 اسحب الملابس وشدها في أثناء استخدام إعداد تعزيز البخار لإزالة التجاعيد المستعصية (لطرّازي DST2020 و DST2030 فقط).



5 لا تستخدم يدك المجردة كسطح دعم في أثناء الكي.

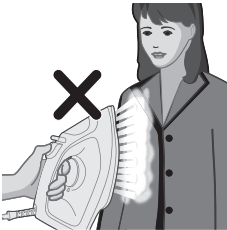

6 لا توجه الجهاز نحوك/نحو شخص آخر.

## إيقاف التشغيل التلقائي (DST2030)

1 لطمأنتك، يبرد الجهاز بمفرده إننا تم تركه بدون مراقبة لفترة من الوقت.

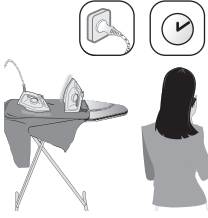

2 عند عدم استخدام الجهاز لأكثر من 30 ثانية أو لمدة 8 دقائق أثناء وضعه على قاعدته، سينتقل إلى وضع إيقاف التشغيل التلقائي.

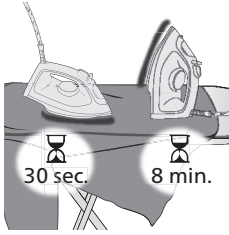

3 ستتنخفض درجة حرارة الجهاز في وضع إيقاف التشغيل التلقائي. سيومض الضوء الذي يشير إلى أن 'المكواة جاهزة' من دون توقف أيضًا للإشارة إلى أن الجهاز في حالة إيقاف التشغيل التلقائي. لإيقاف تشغيل الجهاز تمامًا، افصل الجهاز عن المقبس.

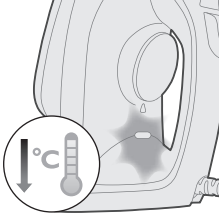

4 لإتاحة بإحماء الجهاز من جديد، ارفعه أو حرّكه قليلاً.

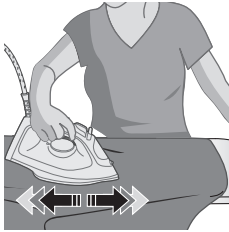

5 سيضيء الضوء الذي يشير إلى أن 'المكواة جاهزة' للإشارة إلى أن الجهاز قيد الإحماء.

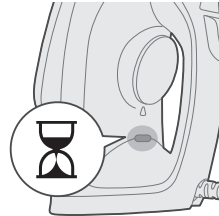

6 بمجرد انطفاء الضوء الذي يشير إلى أن المكواة جاهزة، يصبح الجهاز جاهزاً للاستخدام.

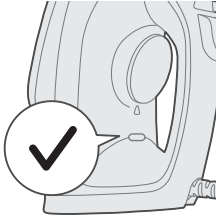

## التنظيف والصيانة

1 تأكد من أن الجهاز غير موصل بمصدر طاقة.

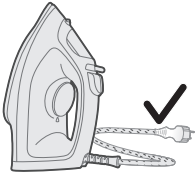
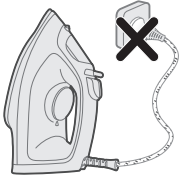

2 تأكد من أن الجهاز قد برد.

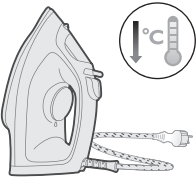

3 امسح الرفائيق والترسبات الأخرى عن قاعدة المكواة باستخدام قطعة قماش رطبة.





ملاحظة: للمحافظة على نعومة قاعدة المكواة، تجنب ارتطامها بالأغراض المعدنية. لا تستخدم أبداً إسفنجة خشنة أو خلاّ أو أي مواد كيميائية أخرى لتنظيف قاعدة المكواة.

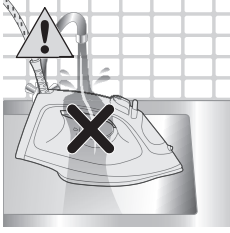

4 لا تغسل/تنظف الجهاز باستخدام المياه الجارية.

## Calc-Clean

تلميح: يمكن استخدام ميزة تحرير الكلس بسرعة في أي وقت كان. إذا كنت تعيش في منطقة حيث المياه عسرة، فاستخدم الميزة بشكل متكرر أكثر.



1 بعد مرور شهر واحد على استخدام الجهاز، يوصى بتنظيف الكلس لإزالة الترسبات الكلسية المجمعة من جهازك لإطالة عمره والتأكد من ارتفاع درجة حرارته.

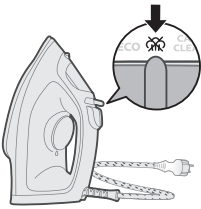

2 تأكد من أن المكواة غير موصلة بمصدر طاقة ومن أن إعداد البخار معيّن إلى وضع "لا بخار" (الكي الجاف) 

3 املأ خزان المياه حتى مؤشر MAX (الحد الأقصى).

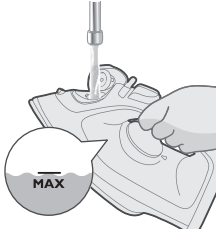

4 قم بتعيين قرص درجة الحرارة إلى MAX (الحد الأقصى).

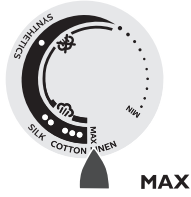

5 قم بتوصيل الجهاز بمقبس حائط مؤرّض.

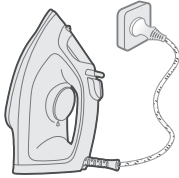

6 سيضيء الضوء الذي يشير إلى أن 'المكواة جاهزة' للإشارة إلى أن الجهاز قيد الإحماء.

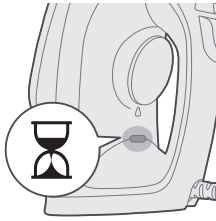

7 انتظر إلى أن ينطفئ الضوء الذي يشير إلى أن 'المكواة جاهزة'.

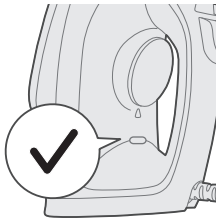

8 فصل المكواة عن مصدر الطاقة.

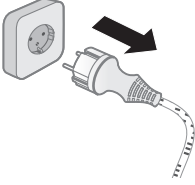

9 مرّر محدد البخار إلى موضع Calc-Clean وثبته في مكانه.

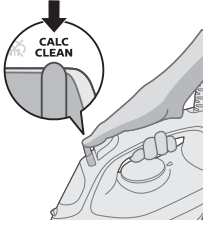

10 أمسك المكواة فوق المغسلة وقم بهزّها بلطف. سيخرج الماء الساخن وجزئيات الكلس من قاعدة المكواة. تنبيه: فيما يتم نطف الكلس إلى الخارج، سيخرج البخار والماء الساخن أيضًا من قاعدة المكواة.



11 استمر في هزّ المكواة حتى يتم إخراج كل المياه في خزان المياه.

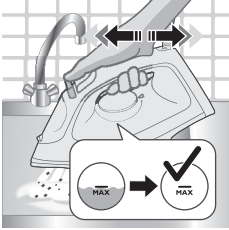

12 قم بتوصيل الجهاز بمصدر الطاقة واتركه ليحمى بهدف تجفيف قاعدة المكواة. يستغرق ذلك حوالي دقيقتين.

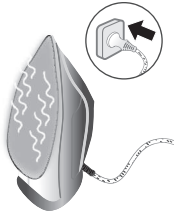

13 دَعّ المكوّاة تبرد.

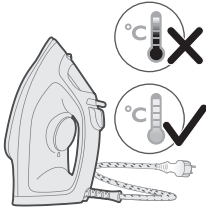

14 قم بلفّ السلك حول قاعدة الجهاز.

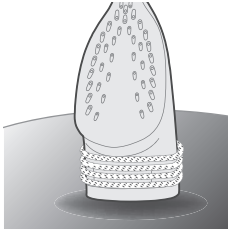

## التخزين

1 مرّر محدد البخار لتحديد وضع "لا بخار" (الكي الجاف) .

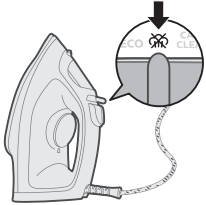

2 أفصل الجهاز عن مصدر التزويد بالطاقة.

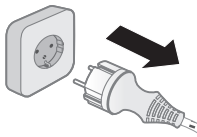

3 اترك الجهاز ليبرد.

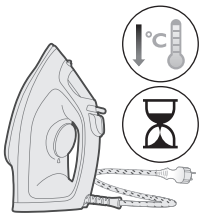

4 أفرغ خزان المياه من أي مياه متبقية.

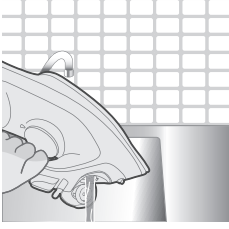

5 قم بلف سلك الطاقة حول الهيكل الرئيسي للجهاز.

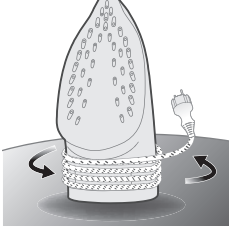

## استكشاف الأخطاء وإصلاحها

يلخص هذا الفصل المشاكل الأكثر شيوعاً التي قد تصادفها عند استخدام الجهاز. في حال لم تتمكن من حل المشكلة بواسطة المعلومات الواردة أدناه، فتفضل بزيارة [www.philips.com/support](http://www.philips.com/support) للاطلاع على لائحة الأسئلة المتداولة أو اتصل بمركز خدمة المستهلك في بلدك.

المشكلة	السبب المحتمل	الحل
لا تستطيع المكنة إزالة التجاعيد من الملابس.	لا يخرج البخار في أثناء الكي.	قم بتعبئة خزان المياه وعين كبسة البخار المتحركة على  .
لا تولد المكنة أي بخار.	لا يوجد ما يكفي من المياه في الخزان.	املا خزان المياه.
	تم تعيين كبسة البخار المتحركة على  .	قم بتعيين كبسة البخار المتحركة على  .
	إن المكنة ليست حامية بما يكفي لإنتاج البخار.	في أثناء إحماء المكنة، يضيء الضوء الذي يشير إلى أن 'المكنة جاهزة' بشكل مستمر. وعندما تصبح المكنة جاهزة للاستخدام، ينطفئ الضوء.
تقطر قطرات الماء على الملابس في أثناء الكي.	لقد استخدمت وظيفة التعزيز بشكل متكرر جداً في غضون مدة قصيرة.	استمر في الكي في الوضع الأفقي وانتظر بعض الوقت قبل استخدام وظيفة تعزيز البخار مرة أخرى.
	لم تقم بإغلاق غطاء خزان المياه بشكل صحيح.	اضغط على الغطاء حتى تسمع 'طققة'.
لا تولد المكنة دفقتاً معزراً من البخار.	لقد استخدمت وظيفة تعزيز البخار بشكل متكرر جداً في غضون مدة قصيرة.	استمر في الكي في الوضع الأفقي وانتظر بعض الوقت قبل استخدام وظيفة تعزيز البخار مرة أخرى.



انتظر حتى يتوقف الضوء الذي يشير إلى أن "المكواة جاهزة" عن الوميض.	إن المكواة ليست حامية بما يكفي للكي بعد.	
اشطف خزان المياه ولا تضع أي عطور أو مواد كيميائية فيه.	لقد وضعت مادة كيميائية في خزان المياه.	
قم بتعيين كبسة البخار المتحركة على  .	تم تعيين كبسة البخار المتحركة على  .	تقطر المياه من قاعدة المكواة بعد فصل المكواة عن الطاقة.
أفرغ خزان المياه بعد الاستخدام، أو خزن المكواة بوضع عمودي.	وضعت المكواة في وضع أفقي وما زال هناك ماء في خزان المياه.	
يمكن استخدام المكواة بأمان على كل الملابس القابلة للكي. إن اللعان أو آثار المكواة ليست دائمة وستزول عند غسل الملابس. تجنب الكي فوق الدرزات أو الطيات. يمكنك أيضاً وضع قطعة قماش قطنية على المنطقة التي ترغب في كيها لتفادي الآثار.	لم يكن سطح قطعة الملابس التي يجب كيها مستويًا، وقد يعود ذلك مثلاً إلى الكي فوق درزة أو طية في القطعة.	ترك المكواة لمعائناً أو آثاراً على الملابس.



- 1 کلید انتخاب بخار
- 2 دکمه افزایش بخار
- 3 اسپری آب
- 4 سیم جمع کن
- 5 درجه دما
- 6 مخزن آب با درب

## استفاده از دستگاه

### آماده سازی برای استفاده

توجه: اولین بار که از دستگاه استفاده می کنید ممکن است کمی بخار کند. این حالت بعد از مدت کمی رفع می شود.

#### نوع آب مورد استفاده

این دستگاه جهت استفاده با آب لوله طراحی شده است. اگر در منطقه‌ای زندگی می کنید که آب سخت است، توصیه می کنیم مقدار مساوی آب لوله و آب مقطر یا بدون املاح را مخلوط کنید. این کار از تشکیل سریع رسوب جلوگیری کرده و عمر دستگاه را افزایش می دهد.

از استفاده از آب معطر، آب خشک کن، سرکه، نشاسته، مواد رسوب زدا، مواد کمکی اتو، آب رسوب زدایی شده با مواد شیمیایی یا سایر مواد شیمیایی خودداری کنید چون ممکن است باعث خشک شدن آب، ایجاد لکه های قهوه ای یا آسیب به دستگاه شود.

### پرکردن مخزن آب

- 1 دستگاه را به برق وصل نکنید.

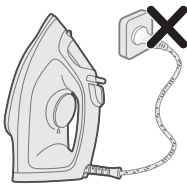

- 2 مطمئن شوید دستگاه خنک شده باشد.

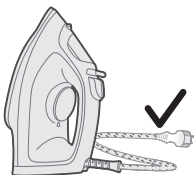

3 انتخاب دما را به راست بچرخانید تا حالت بدون بخار (اتوی خشک) انتخاب شود.

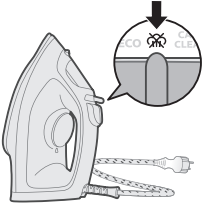

4 درب مخزن آب را باز کنید.

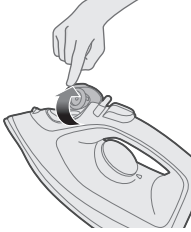

5 مخزن آب را تا علامت MAX پر کنید.

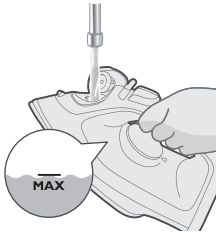

6 درب مخزن آب را محکم ببندید.



## تنظیم دما



حداکثر



نخی



کتابی

ECO

● ●  
ابریشمی●  
الیاف مصنوعی

ECO



تنظیم ECO: برای لباس‌هایی که چروک کمتری دارند، کمترین میزان بخار به طور ثابت و مداوم تولید می‌شود. این تنظیم در مصرف انرژی صرفه جویی می‌کند.



دو ابر بخار: برای چروک‌های سخت، میزان بخار بیشتری به طور ثابت و مداوم تولید می‌شود.



سه ابر بخار: برای چروک‌های سخت، بیشترین میزان بخار به طور ثابت و مداوم تولید می‌شود.

## استفاده از دستگاه

1 برای روشن اتوکشی لازم به برچسب لباس مراجعه کنید.

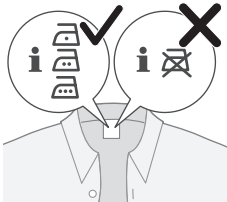

2 درجه دما را به طرف نشانگر دمای مناسب بچرخانید و روی دمای اتوکشی لازم قرار دهید.

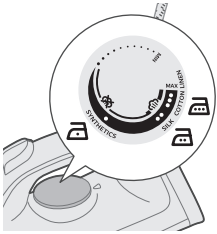

3 اتو را روی پایه‌اش در حالت استراحت قرار دهید.

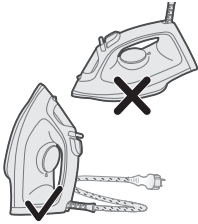

4 دستگاه را به پریز برق با اتصال زمین بزنید.

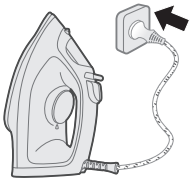

5 چراغ آماده بودن اتو روشن شده و نشان می‌دهد اتو در حال گرم شدن است.

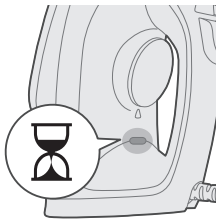

6 وقتی چراغ آماده بودن اتو خاموش شد، کمی صبر کنید و بعد اتوکشی را شروع کنید. چراغ آماده بودن اتو در طول اتوکشی گاهی روشن می‌شود.

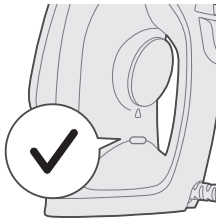

## اتوی خشک/بدون بخار

1 تنظیم بخار را روی تنظیم بدون بخار قرار دهید.

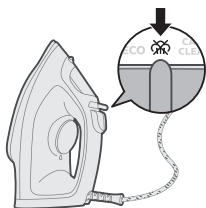

2 بعد از مدت کوتاهی، بخار در حین اتوکشی تمام می‌شود.

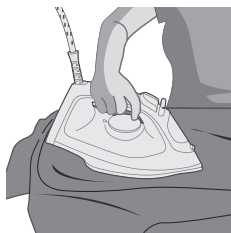

## اسپری آب

1 تنظیم بخار را روی تنظیم بدون بخار قرار دهید. برای چروک‌های سخت، دکمه اسپری آب را فشار دهید و رها کنید تا کمی بخار خارج بشود.

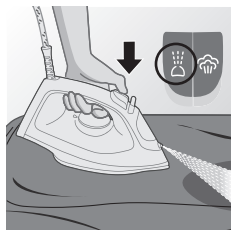

## افزایش دهنده بخار

1 درجه دما را روی MAX بین نخ و کتان قرار دهید.

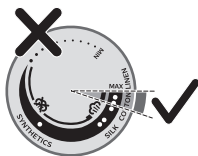



2 دکمه افزایش بخار را فشار داده و رها کنید تا بخار با شدت بیشتری خارج شود و چروک‌های سخت برطرف شوند.



3 می‌توانید از عملکرد افزایش بخار برای هنگامی که در حالت عمودی اتو می‌کنید استفاده کنید تا چروک لباس‌هایی که آویزان کرده‌اید، را از بین ببرید (فقط DST2020 و DST2030).

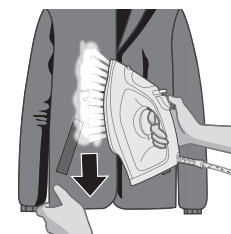

4 هنگام اعمال افزایش بخار برای چروک‌های سخت، لباس را بکشید (فقط DST2020 و DST2030).



5 هنگام اتوکشی از دست بدون دستکش به عنوان تکیه‌گاه استفاده نکنید.

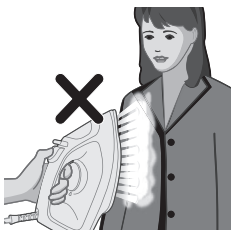

6 از قرار دادن دستگاه به طرف خودتان/یا شخص دیگر خودداری کنید.



## خاموش شدن خودکار (DST2030)

1 اگر دستگاه را برای مدتی رها کنید، خود به خود شروع به خنک شدن می‌کند.

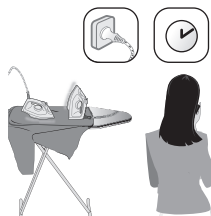

2 اگر دستگاه برای بیشتر از 30 ثانیه روی کف اتو یا بیشتر از 8 دقیقه روی پاشنه بدون استفاده بماند، وارد حالت خاموش شدن خودکار می‌شود.

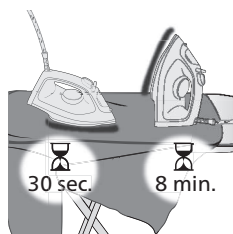

3 دمای دستگاه در حالت خاموش شدن خودکار کاهش می‌یابد. چراغ آماده بودن اتو نیز بی‌وقفه چشمک می‌زند و نشان می‌دهد دستگاه در وضعیت خاموش شدن خودکار است. برای خاموش کردن کامل دستگاه، دوشاخه را از پریز بکشید.

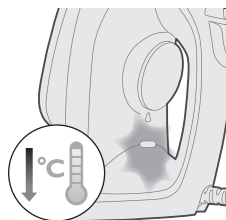

4 برای اینکه دوباره اتو گرم شود، آن را بردارید و کمی حرکت دهید.

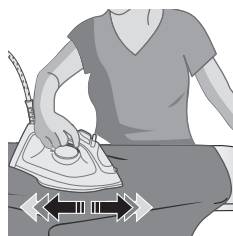

5 چراغ آماده بودن اتو روشن شده و نشان می‌دهد دستگاه در حال گرم شدن است.

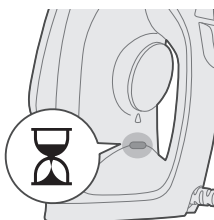

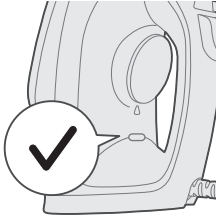

6 وقتی چراغ آماده بودن اتو خاموش نشد، دستگاه برای استفاده آماده است.

## تمیز کردن و مراقبت از دستگاه

1 مطمئن شوید دوشاخه در پریز نباشد.

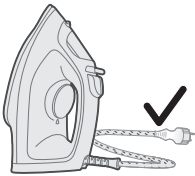
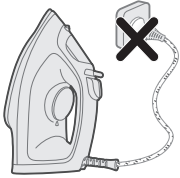

2 مطمئن شوید دستگاه خنک شده باشد.

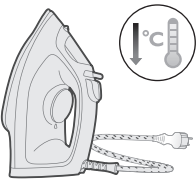

3 رسوب‌ها را با یک پارچه مرطوب از کف اتو پاک کنید.



توجه: برای خنثی برداشتن صفحه کف اتو، از تماس فلزات و اشیای سخت با کف اتو خودداری کنید. هرگز از یک پد سایشی، سرکه یا مواد شیمیایی دیگر برای تمیز کردن صفحه صاف کف اتو استفاده نکنید.



4 دستگاه را زیر آب شیر نشویید/تمیز نکنید.

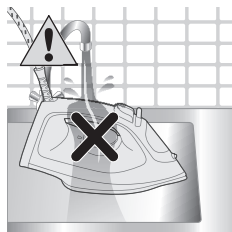

## رسوب زدایی

نکته: عملکرد رسوب زدایی سریع را می توان در هر زمان استفاده نمود. اگر در منطقه ای زندگی می کنید که آب سخت است، از این عملکرد بیشتر استفاده کنید.

1 بعد از 1 ماه استفاده از دستگاه، توصیه می شود برای از بین بردن رسوب های جمع شده در دستگاه و طول عمر بیشتر اتو و اطمینان از گرم شدن آن، رسوب زدایی را انجام دهید.



2 مطمئن شوید اتو از برق کشیده شده باشد و تنظیم بخار روی حالت بدون بخار (اتوی خشک) قرار داشته باشد.

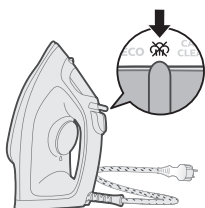

3 مخزن آب را تا نشانگر MAX پر کنید.

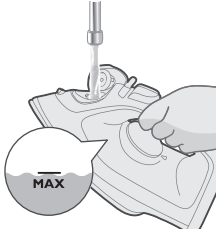

4 درجه دما را روی MAX قرار دهید.



5 دستگاه را به پریز برق با اتصال زمین بزنید.

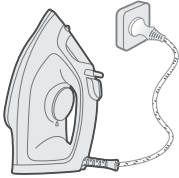

6 چراغ آماده بودن اتو روشن شده و نشان می‌دهد دستگاه در حال گرم شدن است.

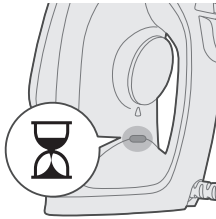

7 صبر کنید تا چراغ آماده بودن اتو خاموش شود.

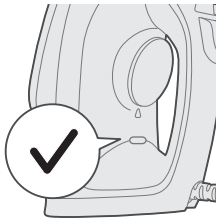

8 اتو را از برق بکشید.

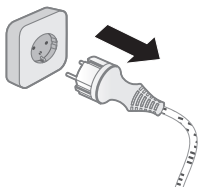

9 کلید انتخاب بخار را روی رسوب‌زدایی بکشید و نگهدارید.

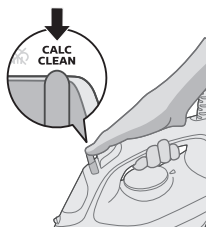

10 اتو را روی سینک ظرفشویی بگیرید و آرام اتو را تکان دهید. آب داغ و ذرات رسوب از کف اتو خارج می‌شود.



احتیاط: در حالی که رسوبات با فشار به بیرون رانده می‌شوند، آب و بخار نیز از صفحه صاف کف اتو به بیرون می‌ریزد.

11 به آرامی اتو را تکان دهید تا وقتی همه آب داخل مخزن آب خارج شود.

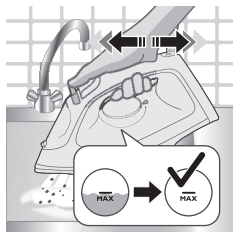

12 اتو را به برق بزنید و بگذارید اتو گرم شده و کف اتو خشک نشود. این کار حدود 2 دقیقه طول می‌کشد.



13 اجازه دهید اتو خنک شود.

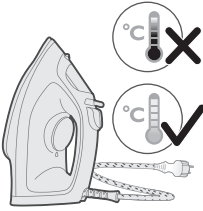

14 سیم برق را دور پایه اتو جمع کنید.

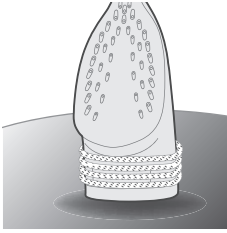

## نگهداری

1 کلید انتخاب بخار را بلغزانید تا روی حالت بدون بخار (اتوی خشک) قرار گیرد.

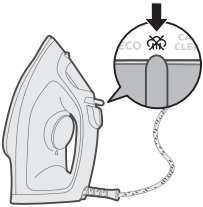

2 دوشاخه را از پریز بکشید.

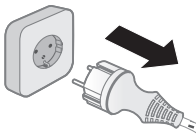

3 اجازه دهید دستگاه خنک شود.

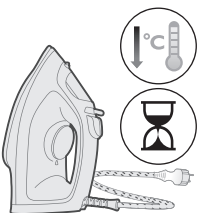

4 باقیمانده آب را از مخزن آب بیرون بریزید.

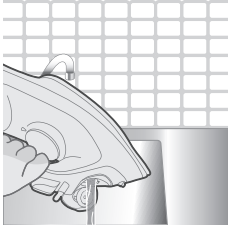

5 سیم برق را دور پایه دستگاه جمع کنید.

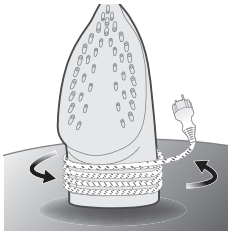

## عیب‌یابی

خلاصه ای از اشکالاتی که ممکن است معمولاً هنگام کار با دستگاه برای شما پیش آید در این بخش گنجانده شده است. اگر نمی‌توانید مشکل را با اطلاعات زیر برطرف کنید، جهت مشاهده لیست سؤالات متداول، از سایت [www.philips.com/support](http://www.philips.com/support) بازدید کنید یا با مرکز خدمات مشتری در کشور خود تماس بگیرید.

اشکال	علت احتمالی	راه حل
اتو نمی‌تواند چروک‌های لباس را از بین ببرد.	در حین اتوکشی، بخار وجود ندارد.	مخزن را از آب پر کرده و کلید بخار را روی  قرار دهید. تنظیم کنید.
اتو هیچ بخاری تولید نمی‌کند.	آب کافی در مخزن آب وجود ندارد.	مخزن آب را پر کنید.
کلید بخار روی  تنظیم شده است.	کلید کشویی بخار را در وضعیت  قرار دهید.	
اتو هنوز برای ایجاد بخار به اندازه کافی داغ نشده است.	وقتی اتو گرم می‌شود، چراغ آماده بودن اتو به طور ثابت روشن می‌ماند. وقتی اتو برای استفاده آماده شد، چراغ خاموش می‌شود.	
در حین اتوکشی قطرات آب روی پارچه می‌ریزد.	در مدت زمان کوتاهی از عملکرد افزایش بخار به مقدار زیاد استفاده کرده‌اید.	به اتوکشی در وضعیت افقی ادامه دهید و کمی صبر کنید، سپس دوباره از عملکرد افزایش بخار استفاده نمایید.
درب مخزن آب را درست نیسته‌اید.	درب مخزن را فشار دهید تا با صدای 'کلیک' بسته شود.	
افزایش بخار در اتو انجام نمی‌شود.	در مدت زمان کوتاهی از عملکرد افزایش بخار به مقدار زیادی استفاده کرده‌اید.	به اتوکشی در وضعیت افقی ادامه دهید و کمی صبر کنید، سپس دوباره از عملکرد افزایش بخار استفاده نمایید.

<p>صبر کنید تا چشمک زدن چراغ آماده بودن اتو متوقف شده و ثابت روشن شود.</p>	<p>اتو هنوز برای اتوکشی به اندازه کافی داغ نشده است.</p>
<p>مخزن آب را بشویید و هیچ عطر یا ماده شیمیایی در مخزن آب نریزید.</p>	<p>یک ماده شیمیایی در مخزن آب ریخته‌اید.</p>
<p>کلید کنشویی بخار را در وضعیت  قرار دهید.</p>	<p>پس از آن که اتو از برق کنشیده شد، قطرات آب از کف اتو خارج می‌شود. کلید بخار روی  تنظیم شده است.</p>
<p>پس از استفاده، آب مخزن را خالی کنید، یا اتو را در وضعیت عمودی قرار دهید.</p>	<p>شما اتو را در حالی که هنوز آب در مخزن آن است، در وضعیت افقی قرار داده‌اید.</p>
<p>این اتو قابل استفاده ایمن بر روی همه لباس‌های قابل اتو می‌باشد. برق یا اثر روی پارچه دائمی نیست و وقتی لباس را بشویید از بین می‌رود. از اتو کردن روی درز یا محل ناهموار خودداری کنید. همچنین می‌توانید یک پارچه نخی روی لباس قرار دهید و اتو کنید تا اثری به جا نماند.</p>	<p>اتو روی لباس برق می‌اندازد یا اثر باقی می‌گذارد. سطح اتوکشی صاف نیست، برای مثال لباس را روی درز یا یک محل ناهموار اتو می‌زنید.</p>













PHILIPS and the Philips Shield Emblem are registered trademarks of Koninklijke Philips N.V. and are used under license.

This product has been manufactured by and is sold under the responsibility of Versuni Holding B.V., and Versuni Holding B.V. is the warrantor in relation to this product.

2024 © Versuni Holding B.V.

642001009690 (11/2024)

**EAC**

