

PHILIPS

Stratosphere
Ultra Efficient
9290033478
9290033636



User manual
Benutzerhandbuch
Notice d'emploi
Manual de usuario
Manual do usuário
Manuale d'uso
Gebruiksaanwijzing

Incl.

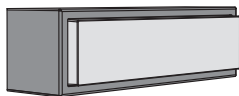

Excl.

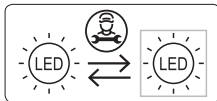
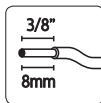
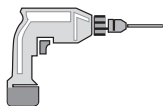

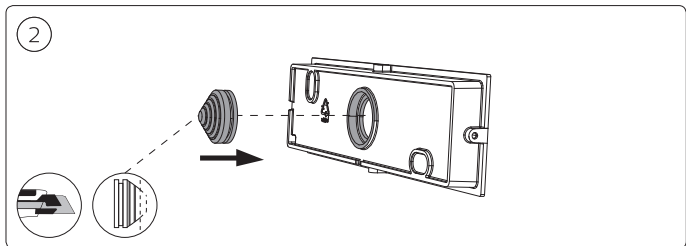
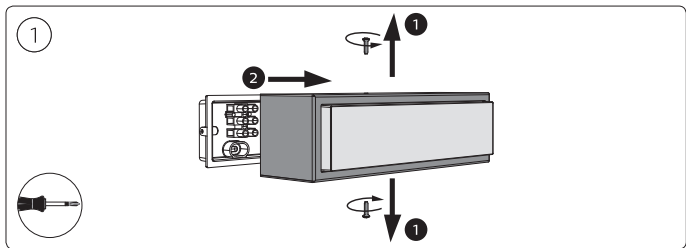
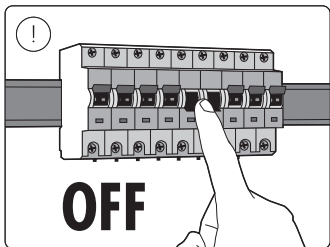
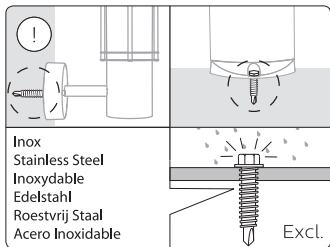

3

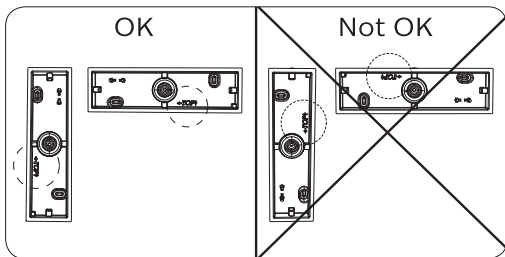
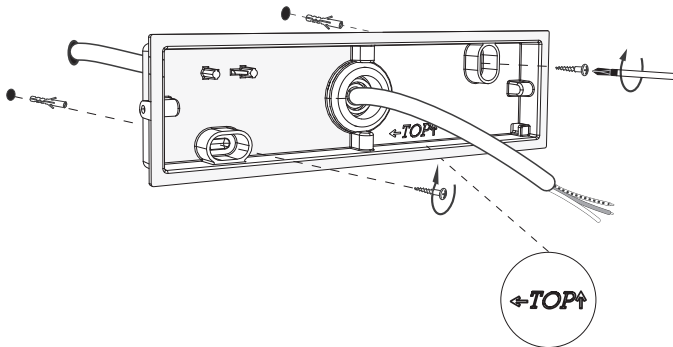

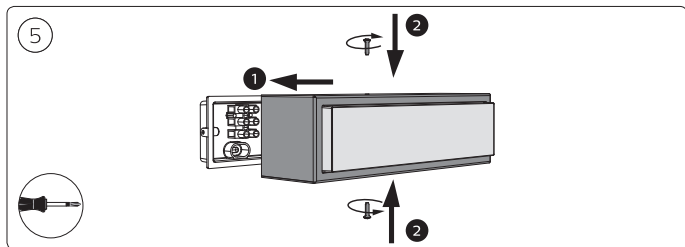
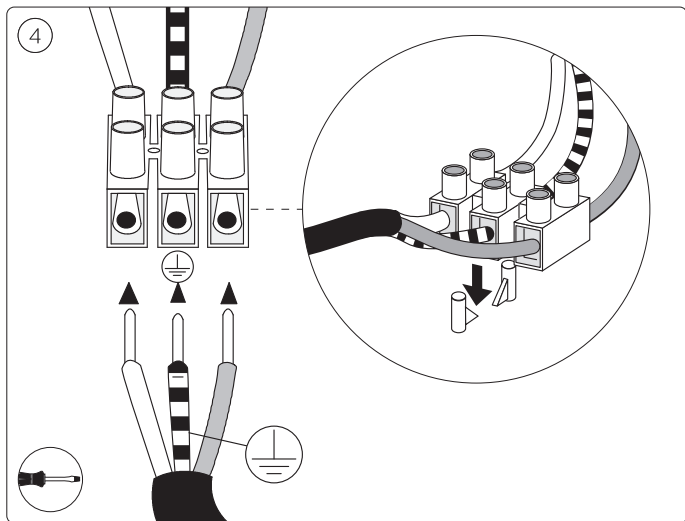

6

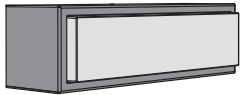

!

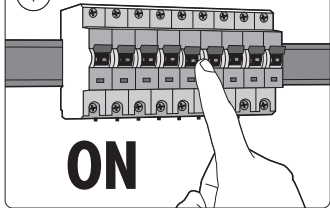



Signify Commercial UK Limited
Unit 3, Guildford Business Park,
Guildford, Surrey, GU2 8XG, UK

Signify
I.B.R.S. / C.C.R.I. Numéro 10461
5600 VB Eindhoven,
the Netherlands
☎00800-74454775

Philips and the Philips Shield Emblem are registered trademarks
of Koninklijke Philips N.V. and are used under license

3241 660 88571
www.philips.com/lighting

© 2023 Signify Holding

 **signify**