

dji OSMO ACTION 5 PRO

Stručný průvodce

v1.0



<https://www.dji.com/osmo-action-5-pro/downloads>

Tento obsah se může změnit bez předchozího upozornění.

DJI je ochranná známka společnosti DJI.
OSMO je ochranná známka společnosti DJI OSMO.
Copyright © 2024 DJI Všechna práva vyhrazena.



YCBZSS00283502

1

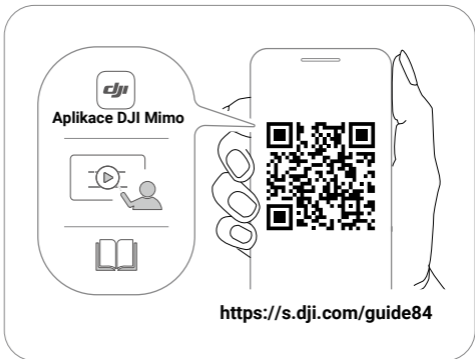

2

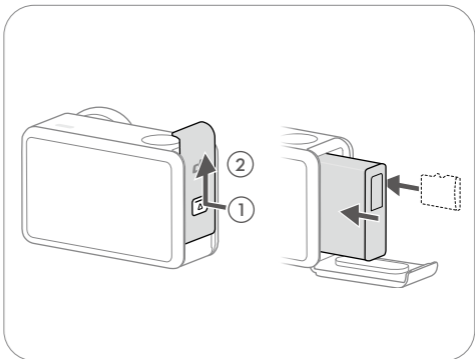

3

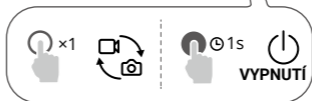
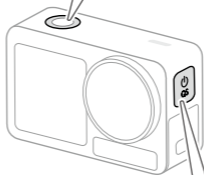
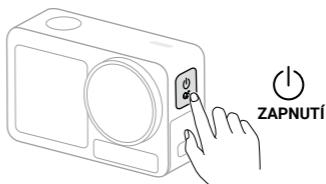

4

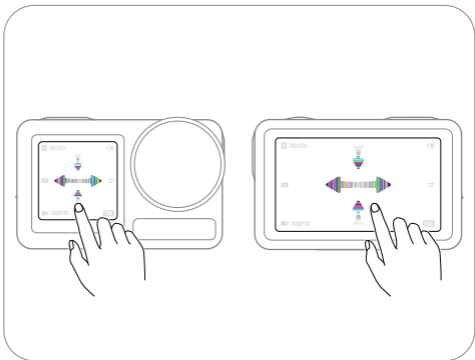

5

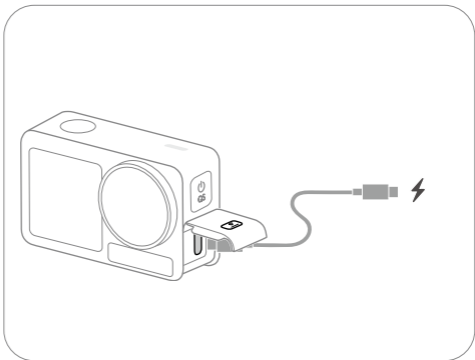

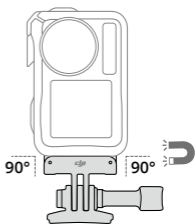
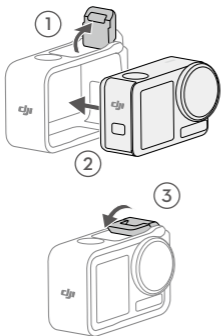
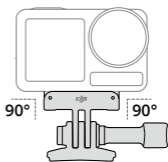
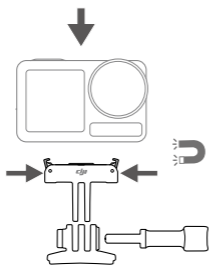

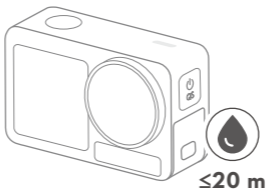

JSME TU PRO VÁS



Kontakt

DJI PODPORA

Dovozce:

Beryko s.r.o.

Pod Vinicemi 931/2, 301 00 Plzeň

www.beryko.cz

PRO VÍCE INFORMACÍ SLEDUJTE NAŠE SOCIÁLNÍ
SÍŤE:



小红书

